

La struttura del Catalogo

The catalog structure

1

Indice Catalogo

Table of contents • Inhaltsverzeichnis • Table des matières • Índice del catálogo

2

Raccorderie Metalliche

Profilo aziendale

Company profile • Firmenprofil • Profil d'entreprise • El perfil de la empresa

3

Il sistema di offerta

Catalogo prodotti completo

Offer system • Das Angebotssystem • Le système d'offre • El sistema de oferta

4

La struttura commerciale

Rete di vendita e informazioni per gli ordini

Commercial structure • Die kommerzielle Struktur unserer Firma • La structure commerciale
• La estructura comercial

➤ Raccorderie Metalliche	
➤ Profilo aziendale	6
Company profile • Firmenprofil • Profil d'entreprise • El perfil de la empresa	
➤ Principali prodotti	9
Main products • Unsere hauptsächlich Produkte • Produits principaux • Los productos principales	
➤ Campi di applicazione	11
Fields application • Anwendungsbereich • Domaines d'application • Ámbitos de aplicación	
➤ I Nostri Progetti	12
Our Projects • Unsere Projekte • Nos Projets • Nuestros Proyectos	
➤ Il sistema di offerta	
Offer system • Das Angebotssystem • Le système d'offre • El sistema de oferta	
➤ Sistemi di raccordi a pressione	16
Press fitting systems • Pressfittingsysteme • Système à sertir • Sistema de accesorios para pensar	
➤ inoxPRES	24
AISI 316L - W. 1.4404	
➤ inoxPRES GA	74
AISI 316L - W. 1.4404	
➤ inoxPRES HT FREE	95
AISI 316L - W. 1.4404	
➤ inoxPRES STEAM	107
AISI 316L - W. 1.4404	
➤ steelPRES	119
Acciaio al carbonio zincato • Carbon steel • C-stahl verzinkt • Acier carbone • Acero carbono galvanizado	
➤ RES PRES	144
Rame/bronzo • Copper/bronze • Kupfer/Bronze • Cuivre/bronze • Cobre/bronze	
➤ RES PRES HT	156
Rame/bronzo • Copper/bronze • Kupfer/Bronze • Cuivre/bronze • Cobre/bronze	
➤ MARINE PRES	167
CuNi10Fe1.6Mn	
➤ Attrezzature e accessori	186
Press tools and accessories • Presswerkzeuge zubehör • Outils de sertissage et accessoires • Herramientas y accesorios	
➤ Sistemi di scarico	208
Waste systems • Abflusssysteme • Systèmes de évacuation • Sistemas de evacuación	
➤ DRAIN	210
AISI 316L - W. 1.4404	
La struttura commerciale	
Commercial structure • Die kommerzielle Struktur unserer Firma • La structure commerciale • La estructura comercial	
➤ Come ordinare	245
How to order • Bestellungsverfahren • Comment commander • Cómo efectuar el pedido	
➤ Struttura commerciale Italia	246
Sales Organisation • Kommerzielle Struktur in Italien • Structure Commerciale Italie • Organización de ventas en Italia	
➤ Struttura commerciale Estero	247
Sales Organisation • Kommerzielle Struktur im Ausland • Organisation des ventes • Organización de ventas en el extranjero	
➤ Condizioni generali di vendita	248
General conditions sales • Allgemeine Verkaufsbedingungen • Conditions générales de vente	
• Condiciones generales de venta	



Raccorderie Metalliche

Azienda certificata

Certified Company



UNI-EN ISO 9001:2015



UNI-EN ISO 14001:2015



ISO 45001-2018-2021



Profilo aziendale

Raccorderie Metalliche rappresenta dal 1970 una realtà di assoluto rilievo nel panorama europeo dei produttori di materiale per l'impiantistica nel **settore idrotermosanitario civile e industriale**. Dal 2014 è presente nel **settore navale** come unico operatore sul mercato in grado di offrire contemporaneamente sistemi pressfitting, sistemi di scarico in acciaio, raccorderia a saldare e filettata e sistemi di fissaggio.

Un'azienda formata da **350 dipendenti** che ogni giorno realizzano la missione di Raccorderie Metalliche.

“Aiutiamo gli installatori a lavorare in modo rapido, sicuro e conveniente, studiando e realizzando ogni giorno soluzioni innovative di prodotto e di processo prestando particolare attenzione all'impiego dei sistemi di raccordi a pressare.”

*(Pier Luigi CECCARDI,
Fondatore e Presidente di Raccorderie Metalliche)*

Presenza nel Mondo

Raccorderie Metalliche dispone di due siti produttivi in Italia, con un totale di oltre 93.000 mq, e 3 filiali commerciali estere (Germania, Francia e Spagna) che garantiscono una distribuzione in oltre 60 Paesi nel mondo.

- **InoxPRES S.A. (Barcellona, Spagna):** commercializzazione di tubi e raccordi su tutto il territorio spagnolo e portoghese.
- **RM Pressfitting GmbH (Monaco di Baviera, Germania):** sviluppo commerciale e coordinamento di un team di promoters sul territorio tedesco.
- **Raccorderie Metalliche FRANCESARL (Lione, Francia):** sviluppo commerciale e coordinamento della struttura di vendita sul territorio francese.

I punti chiave

Il successo di Raccorderie Metalliche è da attribuire ad una pluralità di fattori: conoscenza, qualità, vasto assortimento di gamma ed estrema attenzione al cliente.

- **Costante ricerca e continuo sviluppo di soluzioni innovative** hanno permesso di realizzare il **primo raccordo tee pressfitting** al mondo in acciaio al carbonio privo di saldature.
- **Continui controlli e miglioramenti sulla qualità** hanno consolidato un elevato standard qualitativo.
- **Certificazione dei sistemi di gestione delle proprie attività** nel rispetto dell'ambiente e della sicurezza dei propri collaboratori.
- **Costante disponibilità e tracciabilità** di prodotti presso i nostri magazzini.
- **Tecnici che affiancano e consigliano** i progettisti nel loro lavoro.
- **Trasparenza, correttezza e rispetto reciproco** con i partner permettono di garantire standard elevati di servizio.
- **Continue attività formative e di aggiornamento** per far crescere professionalmente gli installatori.
- **Particolare attenzione al sociale** ritenendo che siano le persone a fare la differenza, quella differenza che permette di evolvere.

Dati di rilievo

Aggiornati a dicembre 2020

➤ Area totale RM	93.000 mq
➤ Superficie coperta RM	58.000 mq
➤ N° dipendenti	350 persone
➤ Fatturato Italia	35%
➤ Fatturato Export	65%
➤ Presenza	in oltre 60 paesi
➤ N° articoli a catalogo	5.818
➤ Materia prima trasformata	20.000tons/anno
➤ Brevetti	7
➤ Certificazioni prodotti	83

Company profile

Since 1970, Raccorderie Metalliche is a leading manufacturer in the European **civil & industrial plumbing sector** landscape.

Since 2014 we are present in the **shipbuilding sector** and the only one in the market being in a position to offer press fitting systems, steel wastewater systems, welding fittings, threaded fittings and fastening systems, at the same time.

Every day, **350 employees** are committed to fulfil Raccorderie Metalliche's mission.

“We constantly offer innovative solutions in terms of both product and process and take the use of press fitting systems into particular consideration; these solutions allow fitters to work rapidly, safely and suitably.”

*(Pier Luigi CECCARDI,
Founder and President of Raccorderie Metalliche)*

Our Presence in the World

Raccorderie Metalliche has two production plants in Italy, extending over an area of more than 93.000 sq. m, as well as 3 branch offices in foreign Countries (Germany, France and Spain) ensuring the distribution of our products in more than 60 Countries of the world.

- ▶ **InoxPRES S.A. (Barcelona, Spain):**
marketing of pipes and fittings in the whole Spanish and portuguese territory.
- ▶ **RM Pressfitting GmbH (Munich, Germany):**
trade development and coordination of our team of promoters in Germany.
- ▶ **Raccorderie Metalliche FRANCE SARL (Lyon, France):**
trade development and coordination of our sales structure in France.

Key Points

Raccorderie Metalliche's success is the result of several factors: knowledge, quality, a wide range of products, particular ability to understand customer requirements.

- ▶ **Continuous research and development of innovative solutions** allowing us to be the first Company producing a seamless carbon steel **pressfitting Tee**.
- ▶ **Continuous quality control and improvement** resulting in a high quality level.
- ▶ **Certification of activities managing systems** in conformity with environment and workers' safety regulations.
- ▶ **Constant availability and traceability** of products in our warehouses.
- ▶ **Technicians collaborating with and giving advice** to the design engineers.
- ▶ **Fairness, transparency and mutual respect** between the partners to provide our customers with the best possible service.
- ▶ **Constant training and update** in order fitters to continue their professional development.
- ▶ **Particular attention to social issues**, because we think that people make the difference, which is the key ingredient for evolution.

Highlights

Updated on December 2020

▶ RM total area	93.000 sq.m
▶ RM covered area	58.000 sq.m
▶ Human resources	350 people
▶ Domestic sales	35%
▶ Export sales	65%
▶ Presence	in over 60 countries
▶ Item on catalouge	5.818
▶ Processed raw materials	20.000tons/year
▶ Patents	7
▶ Products Certifications	83

Pressare, Innestare, Innovare!

I sistemi di Raccorderie Metalliche **prodotti in Italia** si dividono in:

Sistemi **Pressfitting**

inoxPRES®

Acciaio inossidabile AISI 316L

steelPRES®

Acciaio al carbonio E195

MARINE PRES®

Cupronichel 90/10

AES PRES®

Rame Cu-DHP 99.9 / Bronzo CuSn5Zn5Pb2-C / CC449K

I Sistemi Pressfitting di Raccorderie Metalliche sono composti da raccordi, tubazioni* e attrezzature.

Le nostre soluzioni sono progettate per impianti di distribuzione acqua potabile, antincendio, climatizzazione, aria compressa e trasporto fluido in genere.

**PRESSIONE DI ESERCIZIO FINO A PN16.
DISPONIBILITÀ NEI DIAMETRI DA 15 mm A 168 mm.**

Tutti i prodotti seguono un processo di tracciabilità che permette l'identificazione di ogni singolo componente per qualsiasi evenienza.

Sistemi **di scarico**

DRAIN è un sistema ad innesto composto da tubi e raccordi in acciaio inossidabile AISI 316L per il trasporto di acque di scarico bianche, grigie e nere; la soluzione ideale per la realizzazione reti di scarico sia in gravità che in vuoto.

I sistemi di fissaggio, raccorderia **a saldare / filettata, flange**

I nostri sistemi di fissaggio, la raccorderia a saldare e filettata, le flange rappresentano il giusto completamento per fornire un'intera gamma di prodotti che soddisfino a 360° l'esigenza per tutti i tipi di impianti.

* Tranne per il sistema AesPRES®

Raccorderie Metalliche Systems **produced in Italy** are divided as follows:

Pressfitting Systems

inoxPRES® Stainless Steel AISI 316L

steelPRES® Carbon Steel E195

MARINE PRES® Copper-nickel 90/10

AES PRES® Copper Cu-DHP 99.9 / Bronze CuSn5Zn5Pb2-C / CC449K

Raccorderie Metalliche Pressfitting Systems include fittings, piping* and tools. Raccorderie Metalliche Pressfitting Systems are designed for multiple application fields: distribution systems of drinking water, fire protection systems, air conditioning, compressed air, and fluid transport systems in general.

**WORKING PRESSURE UP TO PN16.
AVAILABLE FROM 15 mm TO 168 mm.**

All products follow a traceability process which allows each and every component to be identified.

Waste Systems

DRAIN is a push-fit system composed of pipes and fittings in AISI 316L stainless steel for the transport of white, grey and black wastewater; the ideal solution for the construction of gravity and vacuum drainage networks.

Fastening, welding / threaded fitting systems, flanges

Our fastening, welding/threaded fitting systems and flanges represent the correct completion of products to provide a full range which meets the 360° requirements for all installations.

* Except for AesPRES® system

Press, Push, Innovate!



Campi di *applicazione* Fields of *application*

Raccorderie Metalliche offre tutte le soluzioni per l'adduzione e lo scarico di acqua ed il trasporto di svariati fluidi.

I sistemi Pressfitting di Raccorderie Metalliche si distinguono per **semplicità, rapidità e sicurezza**.

- > La **semplicità** è intrinseca nelle caratteristiche del sistema: taglia, innesta e pinza, nessun patentino, nessuna fiamma.
- > La **rapidità** permette di abbattere i tempi di installazione fino al 60% rispetto ai sistemi tradizionali.
- > La **sicurezza** è data dall'assenza di rischi d'incendio e dal mantenimento di un ambiente di lavoro pulito ed ordinato, anche in condizioni di spazio ristretto.

Raccorderie Metalliche offers all possible solutions for the supply and drainage of water and for the transport of diverse fluids.

Raccorderie Metalliche Pressfitting systems stand for **simplicity, speed and security**.

- > **Simplicity** is inherent in the system's characteristics: cut, insert and press, no flame, no licence needed.
- > **Speed of installation** makes it possible to reduce labour time by up to 60% and high safety levels compared to traditional systems.
- > **Security** is provided by the absence of fire risks and by maintaining a clean working environment, even in a restricted working space.

inoxPRES®

steelPRES®

AES PRES®

MARINE PRES®

DRAIN

Applicazioni Applications	Acciaio inossidabile Stainless Steel	Acciaio al carbonio Carbon Steel	Rame / Bronzo Copper / Bronze	Cupronichel Copper-nickel	Acciaio inossidabile Stainless Steel
Acqua potabile Potable Water	✓		✓		
Gas metano / GPL Natural Gas / LPG	✓		✓		
Riscaldamento Heating	✓	✓	✓	✓	
Raffrescamento Cooling	✓	✓	✓	✓	
Solare termico Solar Thermal	✓	✓	✓	✓	
Aria compressa Compressed Air	✓	✓	✓	✓	
Antincendio Fire Protection Systems	✓		✓	✓	
Acque di processo Process Water	✓			✓	✓
Scarichi Wastewater				✓	✓
Nebulizzazione Nebulisation	✓				
Silicone free Silicone Free	✓				
Vapore Steam	✓				



Acqua potabile
Potable Water



Gas metano / GPL
Natural Gas / LPG



Riscaldamento
Heating



Raffrescamento
Cooling



Solare termico
Solar Thermal



Aria compressa
Compressed Air



Antincendio
Fire Protection
Systems



Acque di processo
Process Water



Scarichi
Wastewater



Nebulizzazione
Nebulisation



Silicone Free
Silicon Free



Vapore
Steam



Condividi le foto dei tuoi **impianti!**

SHARE PHOTOS OF YOUR PLANTS !

Hai realizzato un impianto utilizzando i nostri sistemi pressare?

Inviaci le foto e i dettagli della tua installazione
all'indirizzo mail marketing@racmet.com,
le pubblicheremo sui nostri canali web.

*Did you build a system using our pressfitting systems?
Send us the photos and details of your installation
to the email address marketing@racmet.com and
we will post them on our web channels.*

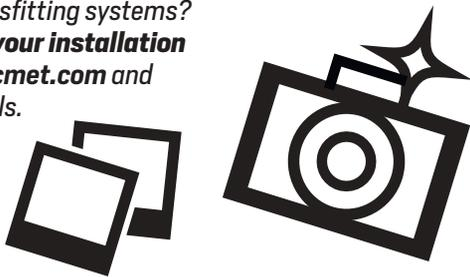

20 anni di pressfitting: pronti per il BIM

20 YEARS OF PRESSFITTING: READY FOR BIM

I sistemi a pressare, diventati oggi il core business di Raccorderie Metalliche, festeggiano oltre 20 anni di pressfitting dalla loro prima produzione del 1999.

Modellazione ad estrema precisione e contenuti aggiornati, leggeri e compatti con **BIM (Building Information Modeling)**, l'App gratuita di Raccorderie Metalliche!
Progetta gli impianti con i nostri sistemi a pressare in modo rapido e semplice!

Pressfitting systems are nowadays Raccorderie Metalliche's core business. We celebrate more than 20 years of pressfitting. Our first production dates back to 1999.

*Design with great accuracy and work with up-to-date, light and compact **BIM (Building Information Modeling)** content with the free App of Raccorderie Metalliche!
Design piping systems easily and fast!*



Librerie BIM per REVIT - BIM library for REVIT

20
Since
1999

**Pressfittings
Anniversary**

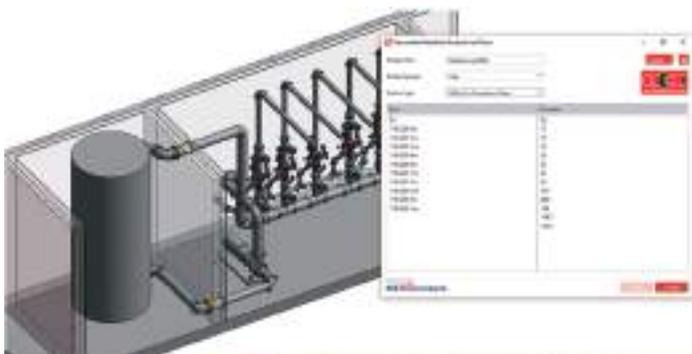

SCARICA L'APP GRATUITA
DOWNLOAD THE FREE APP

Progetta gli impianti con i nostri sistemi a pressare in modo rapido e semplice!

Design piping systems easily and fast!

Free Download



La nostra nuova **RacMet Academy**

WE ARE OPENING THE NEW RACMET ACADEMY

La nuova **RacMet Academy** è il risultato dell'importanza che viene data alla crescita professionale e alla formazione di installatori e collaboratori.

Una nuova struttura formata da ampi spazi dotati delle più avanzate e moderne tecnologie per supportare meeting e convention, un laboratorio tecnico che include una ambientazione specifica per ogni applicazione dedicata ai sistemi di raccordi a pressare, una school dedicata alla formazione ed una zona lounge per l'accoglienza degli ospiti e il relax.

Scopri-la sul nostro sito!

*The new **RacMet Academy** is the result of the importance given to professional growth and the training of installers and employees.*

A new structure consisting of large spaces equipped with the most advanced and modern technologies to support meetings and conventions, a technical laboratory with a specific setting for each application dedicated to pressfittings, a school dedicated to training and a lounge area for the reception of guests and relaxation.

Discover it on our website!

UNA STRUTTURA TECNICA SEMPRE **PIÙ VICINA AI NOSTRI CLIENTI**

A TECHNICAL STRUCTURE CLOSER TO OUR CUSTOMERS

 tecnico@racmet.com





Sistemi di raccordi a pressare

PRESS FITTING SYSTEMS

PRESSFITTINGSYSTEME

SYSTÈME À SERTIR

SISTEMA DE ACCESORIOS PARA PRENSAR

Il sistema **pressfitting**

RACCORDERIE METALLICHE utilizza per i propri prodotti la tecnica di giunzione con profilo "M". Durante la pressatura avviene una deformazione a 2 livelli. Il primo livello di resistenza si realizza in seguito alla deformazione meccanica del raccordo e della tuba-

zione, un collegamento indissolubile che garantisce la resistenza meccanica dello stesso. La tenuta idraulica viene garantita dall'O-Ring deformato nella sua sezione: grazie alla sua elasticità, garantisce l'ermeticità permanente della giunzione.

Il profilo dell'anello di tenuta (O-Ring)

I tradizionali sistemi di raccordi a pressare utilizzano anelli di tenuta (O-Ring) a sezione circolare che in caso di lavorazione non appropriata, sono facilmente soggetti ad essere danneggiati. Raccorderie Metalliche usa un'anello di tenuta brevettato a profilo lenticolare (lenring) che aderisce perfettamente alla camera toroidale. Ne conseguono i seguenti vantaggi:

- > Una superficie di tenuta maggiore del 20%;
- > Notevole diminuzione del rischio di danneggiamento dell'anello di tenuta;
- > Facilita l'inserimento del tubo.

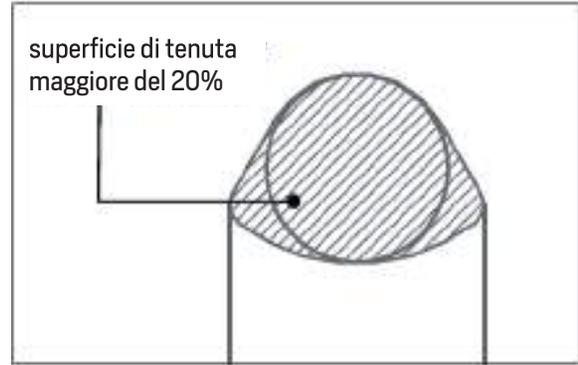

Il materiale impiegato nella realizzazione dei raccordi e dei tubi

I raccordi ed i tubi della linea INOXPRES® sono in acciaio inossidabile AISI 316L. A differenza dei tradizionali sistemi in acciaio AISI316, i prodotti INOXPRES® presentano un minor contenuto di carbonio che conferisce all'acciaio una maggiore resistenza alla corrosione.

Anelli di tenuta - Campi di impiego e caratteristiche tecniche

INDICAZIONI TECNICHE	COLORI	TEMPERATURE D'ESERCIZIO MIN / MAX GRADI CELSIUS	PRESSIONE D'ESERCIZIO MAX IN BAR	OMOLOGAZIONE ENORME	CAMPI D'IMPIEGO	INSERITO IN FABBRICA
EPDM	■ Nero	-20 / +120 °C	16	KTW W 270 DVGW W 534	Acqua potabile, Riscaldamento Circuiti di raffreddamento, Acque trattate, Acque completamente dissalate, Acqua piovana, Aria compressa [Classe 1 ÷ 4]	si
NBR HNBR	■ Giallo	-20 / +70 °C	5	G 260HTB DVGW G 5614	Gas naturale, Gas metano, GPL (fase gassosa)	si
FKM	■ Verde	-20 / +220 °C	16	-	Solare, Aria compressa (Classe 5), Acqua salmastra	si
STEAM	□ Bianco	-20 / 165 °C	7 bara / 6 barg	-	Vapore saturo	si
MVQ	■ Rosso	-20 / +180 °C	16	-	Applicazioni industriali dopo la verifica da parte di RM	no

Norma di riferimento EN 10217-7:2005

WERKSTOFF NR.	C ≤ %	SI ≤ %	MN ≤ %	P ≤ %	S ≤ %	N ≤ %	CR %	MO %	NI %
AISI316 / W.1.4401	0,07	1	2	0,05	0,02	0,11	16,5	2	10
X5CrNiMo 17-12-2									
AISI316L / W. 1.4404	0,03	1	2	0,05	0,02	0,11	18,5	2,5	13
X2CrNiMo 17-12-2									

Pressfitting system

The junction connection of RACCORDERIE METALLICHE pressfitting systems is with "M" contour. During the pressing process a deformation takes place on two planes. The first plane creates a permanent connection and provides

mechanical strength through the mechanical deformation of the press fitting and the pipe. On the second plane the seal ring is deformed in its cross section and through its elastic properties creates the permanently tight joint.

Sealing ring profile (O-Ring)

Traditional pressfitting systems use round sealing rings, which can easily be damaged by careless fitting. RM on the other hand uses a patented sealing ring with a lenticular profile which fits the press crimp groove. This provides the following advantages:

- > A 20% enlargement of the sealing surface area;
- > Major reduction of the risk of the sealing ring being pressed out or damaged;
- > Fit makes the pipes insertion easier.

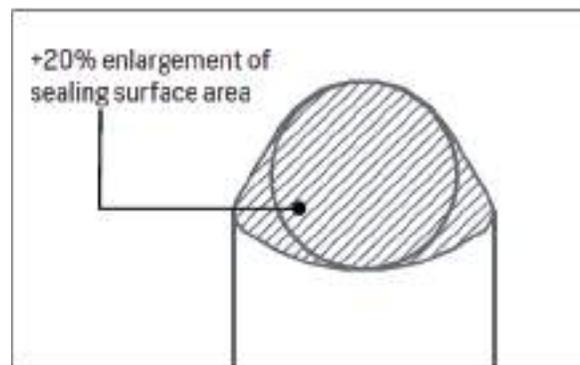

Description of the material used to produce stainless steel pipes and fittings

Pipes and fittings of INOXPRES® are made in stainless steel AISI 316L. Unlike traditional systems made with AISI316, INOXPRES® products present a lower content of carbon that gives a higher resistance to corrosion.

Sealing rings - Fields of applications and technical data

TECHNICAL TERM	COLOUR	OPERATING TEMPERATURE MIN. -/MAX. DEGREES CENTIGRADE	OPERATING PRESSURE MAXIMUM IN BAR	APPROVALS AND CERTIFICATION BASIS	FIELDS OF APPLICATION	FACTORY FITTED
EPDM	■ black	-20 / +120 °C	16	KTW W 270 DVGW W 534	Potable water, Heating, Cooling and refrigeration circuits, Treated water, Desalinated water, Rain-water, Compressed air (Class 1÷4)	yes
NBR HNBR	■ yellow	-20 / +70 °C	5	G 260HTB DVGW G 5614	Natural gas, Methane gas, GPL (gaseous state)	yes
FKM	■ green	-20 / +220 °C	16	-	Solar, Compressed air (Class 5), Salt water	yes
STEAM	□ white	-20 / 165 °C	7 bara / 6 barg	-	Saturated Steam	yes
MVQ	■ red	-20 / +180 °C	16	-	Industrial applications following approval by RM	no

Reference norm EN 10217-7:2005

WERKSTOFF NR.	C ≤ %	SI ≤ %	MN ≤ %	P ≤ %	S ≤ %	N ≤ %	CR %	MO %	NI %
AISI316 / W.1.4401	0,07	1	2	0,05	0,02	0,11	16,5	2	10
X5CrNiMo 17-12-2									
AISI316L / W.1.4404	0,03	1	2	0,05	0,02	0,11	18,5	2,5	13
X2CrNiMo 17-12-2									

Le fasi di **installazione**

Installation process



Attrezzatura per la preparazione del tubo / Tools for the pipe set-up



Macchine e attrezzature per la pressata / Pressing machines and tools



Taglio del tubo / Cutting the pipe to length



Sbavatura del tubo / Deburring the pipe



Controllo O-ring / Checking the sealing ring



Marcatura della profondità d'innesto / Marking the insertion depth



Preparazione della macchina pressatrice / Press machine preparation



Assemblaggio attraverso pressatura / Making the press connection



Controllo della pressatura / Checking the press connection

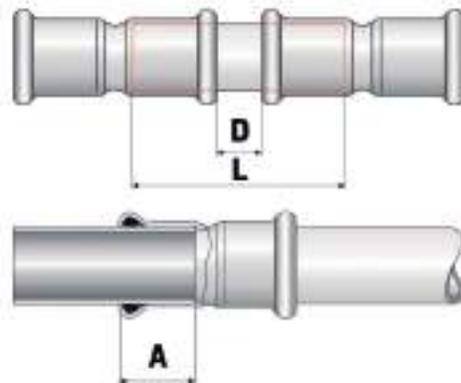

Profondità d'innesto e distanze minime

Insertion depth and minimum distances

VIDEO TUTORIAL

Scopri sul nostro canale YouTube, come installare il sistema Pressfitting!

Find out more on our YouTube channel, how to install Pressfitting system!

YouTube

RACCORDERIE METALLICHE

Diametro esterno tubi in mm Pipe outside diameter in mm	A mm	D mm	L mm
12	18	20	56
15	20	20	60
18	20	20	60
22	21	20	62
28	23	20	66
35	26	20	72
42	30	40	100
54	35	40	110
76,1	55	60	170
88,9	60	60	180
108	75	60	210
139,7	95	100	290
168,3	113	100	326

FOCUS ON 

LA GIUNZIONE OVERSIZE DIAMETRO 139-168 mm

THE OVERSIZE RANGE DIAMETER 139-168 mm

OVERSIZE è una nuova gamma a pressare in acciaio inossidabile AISI 316L disponibile nei diametri 139.7 e 168.3 mm.

Diversamente dai diametri fino a 108 mm, le fasi di pressatura delle dimensioni Oversize 139,7 e 168,3 mm devono essere realizzate attraverso due fasi di pressatura distinte.

Con la catena dedicata si procede secondo le sottostanti fasi di lavoro.

The Oversize is a new pressfitting range, made of AISI 316L stainless steel available in 139 and 168mm diameters.

Unlike diameters up to 108 mm, the pressing phases of the Oversize 139.7 and 168.3 mm dimensions must be carried out in two distinct pressing phases.

Using the dedicated chain, follow the instructions listed below.



1° FASE di PRESSATURA

- Aprire la catena e posizionarla sul raccordo: la scanalatura della catena deve essere posizionata esattamente sopra la camera toroidale del raccordo.
- Chiudere la catena e premere il pulsante di blocco.
- Ruotare il fermo verso l'interno ed innestare il blocco.
- Effettuare l'operazione di pressatura n° 1.
- Sganciare e ruotare il fermo, aprire la catena e rimuoverla dal raccordo.

1st PRESSING PHASE

- Open the chain and place it around the fitting: the groove of the chain must be positioned exactly above the toroidal chamber of the fitting.
- Close the chain and press the lock button.
- Rotate the latch inwards and engage the lock.
- Carry out pressing operation n° 1.
- Unhook and rotate the latch, open the chain and remove it from the fitting.

Assemblaggio pressatura n°1 / Press assembly phase 1



Scanalatura della catena sopra la sede di contenimento dell'o-ring
Chain groove above the o-ring groove

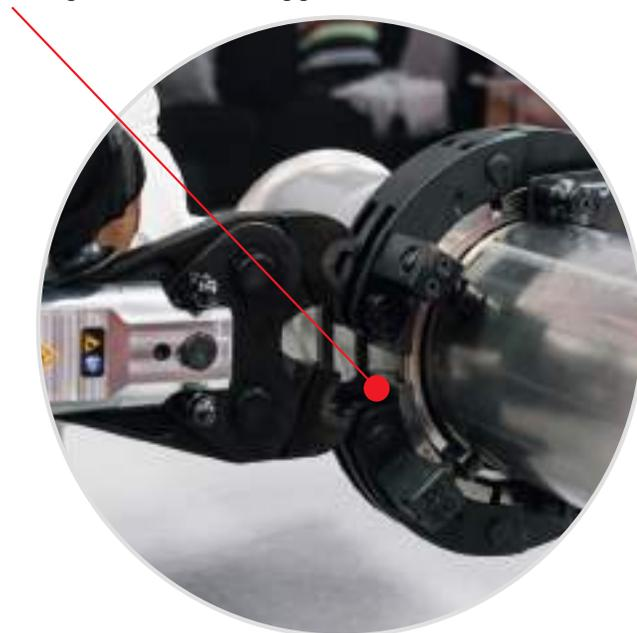

VIDEO TUTORIAL

Scopri sul nostro canale YouTube come installare la nuova gamma Oversize!

YouTube

Find out more on our YouTube channel, how to install the new Oversize range!

RACCORDERIE METALLICHE

2° FASE di PRESSATURA

- a) Posizionare la catena nella zona del “bicchiere”, allineandola con le apposite guide sopra la sede di contenimento dell’o-ring.
- b) Chiudere la catena e premere il pulsante di blocco.
- c) Ruotare il fermo verso l'interno ed innestare il blocco.
- d) Effettuare l'operazione di pressatura n° 2.
- e) Sganciare e ruotare il fermo, aprire la catena e rimuoverla dal raccordo.

Assemblaggio pressatura n°2 / Press assembly phase 2



Controllo visivo pressatura Oversize / Visual inspection of oversize pressing

L'installatore deve inoltre assicurarsi che tutte le giunzioni siano effettivamente state pressate.

A pressatura avvenuta, le giunzioni non devono più essere sollecitate meccanicamente.

L'allineamento della tubazione e il fissaggio dei collegamenti filettati devono essere effettuati prima della pressatura.

È comunque consentito muovere e sollevare leggermente la tubazione, ad es. per lavori di verniciatura.

2nd PRESSING PHASE

- a) Position the chain around the pipe socket, aligning it with the appropriate guides above the containment groove of the o-ring.
- b) Close the chain and press the lock button.
- c) Rotate the latch inwards and engage the lock.
- d) Carry out pressing operation n° 2.
- e) Unhook and rotate the latch, open the chain and remove it from the fitting.

Guide sopra la sede di contenimento dell'o-ring
Guides over the o-ring groove

Dopo la pressatura occorre verificare che la giunzione sia stata realizzata correttamente e che la profondità d'innesto sia stata rispettata.

After pressing, the connection must be checked to ensure that the work has been carried out correctly and that the insertion depth is correct.

The fitter must also ensure that all connections have been adequately pressed.

Once pressing has been complete, the connections must not be subjected to further mechanical loads.

The alignment of the pipeline and the fixing of the threaded connections must therefore be carried out before pressing.

Slight movement and lifting of pipes, e.g. for painting work, is permitted.

Certificazioni / Certifications

SETTORE CIVILE / CIVIL SECTOR

		PRODUKTE DER WASSERVERSORGUNG	DW-8511AU2084 (W 534)	Ø 15 – 168 mm
		EDELSTAHLROHR "INOXPRES" - 1.4404	DV-7301 BM3426 (GW 541)	Ø 15 – 108 mm
		EDELSTAHLROHR "INOXPRES" - 1.4521	DW-7301 BT0667 (GW 541)	Ø 15 – 54 mm
		ROHRSYSTEM EDELSTAHL "INOXPRES" PRESSFITTINGSYSTEM AUS EDELSTAHL DN 20 BIS DN 80 VERWENDUNG: IN ORTSFESTEN WASSERLÖSCHANLAGEN	G 4060006 (VdS 2344 - VdS 2100)	Ø 22 – 88,9 mm
		TRINKWASSERHAUSINSTALLATIONSSYSTEM = INOXPRES®=	W 1.402 (W 402)	Ø 15 – 108 mm
		TRINKWASSERVERTEILSYSTEME	0007-4278 (ZW 132-GW514-W534)	Ø 15 – 108 mm
		INOXPRES RANGE OF STAINLESS STEEL FITTINGS	1710345	Ø 15 – 108 mm
		SYSTÈMES DE CANALISATIONS DE DISTRIBUTION D'EAU - SYSTÈME INOXPRES	79-2217	Ø 15 – 108 mm
		ATTESTATION DE CONFORMITE SANITAIRE - SYSTÈME INOXPRES	18 ACC LY 875	Ø 15 – 108 mm
		PRESFITTINGS TIL RUSTFRI STÅLRØR INOXPRES RUSTFRI STÅLRØR TIL BRUGSVANDSINSTALLATIONER I BYGNING OG JORD INOXPRES	VA 1.22/19224 VA 1.12/18410	Ø 15 – 108 mm
		INOXPRES PIPES INOXPRES FITTINGS	02/00014 03/00127	Ø 15 – 108 mm
		PRESSKOPPLINGAR FÖR ROSTFRIA STÅLRÖR	1174/99	Ø 15 – 108 mm
		STAINLESS STEEL PRESS FITTING - INOXPRES® - (WATER SUPPLY) STAINLESS STEEL TUBE - INOXPRES® - (WATER SUPPLY)	K40834/05 K40835/04	Ø 15 – 108 mm
		INOXPRES PRESSFITTINGSYSTEM I RUSTFRITT STÅL	Nr. 1623	Ø 15 – 108 mm
		INOXPRES PRESSFITTING SYSTEM	POCC IT. AM05.H05079	Ø 15 – 108 mm
		STAINLESS STEEL INOXPRES CRIMP FITTINGS (WATER SUPPLY)	TEST REPORT ZH 173	Ø 15 – 108 mm
		ROZSDAMENTES ACÉL CSÖVEK ÉS PRÉSIDOMOK INOXPRES	A-42/2017	Ø 15 – 108 mm
		INOXPRES ELNEVEZÉSŰ FITTINGEK Ø 15-108 MM	KEF-4416-2/2016	Ø 15 – 108 mm
		LACZNIKI ZAPRASOWYWANE ZE STALI SYSTEMU INOXPRES I STEELPRES DO LACZENIA RUR ZE STALI	ITB-KOT-2019/1222	Ø 15 – 108 mm
		ATEST HIGIENICZNY - INOXPRES	B-BK-60210-0051/20	Ø 15 – 108 mm
		RURY I KSZTAŁTKI DN 20 DO DN 65, ZE STALI NIERDZEWNEJ, SYSTEM INOXPRES	AT-1106-0269/2010/2015	Ø 22 – 76,1 mm
		SYSTEM OF STAINLESS STEEL PIPES AND STAINLESS COMPRESSING FITTINGS INOXPRES	202/C5/2019/B-01337-19	Ø 15 – 108 mm
		RACCORDI A PRESSARE IN ACCIAIO INOSSIDABILE / STAINLESS STEEL PRESSFITTINGS PRODOTTI E COMPONENTI UTILIZZATI A CONTATTO CON ACQUA POTABILE PRODUCT AND ELEMENTS IN CONTACT WITH DRINKING WATER	ICIM-CAP-009671-00	Ø 15 – 168,3 mm
		WATER SUPPLY - METALLIC FITTINGS AND END CONNECTORS; STAINLESS STEEL PIPES AND TUBE FOR PRESSURE APPLICATIONS	WMK25928 WMK25929	Ø 15 – 108 mm

Certificazioni / Certifications

SETTORE NAVALE / SHIPYARD SECTOR

		MECHANICAL JOINTS COMPRESSION COUPLINGS PRESSTYPE	38058/B0 BV	Ø 15 – 108 mm
		TUBE FITTINGS - INOXPRES	TAP000017J	Ø 15 – 108 mm
		PRESS FIT SYSTEM OF COMPRESSION TYPE FOR PIPING SYSTEMS	15/20055 (E1)	Ø 15 – 108 mm
		INOXPRES PIPE PENETRATION (STANDARD FIRE TEST) Ø 15-108 MM	MED 1650182	Ø 15 – 108 mm
		GIUNTI MECCANICI PER TUBOLATURE - INOXPRES MECHANICAL JOINTS FOR PIPES - INOXPRES	MAC 216718CS/002 - 003	Ø 15 – 108 mm
		INOXPRES, PIPING SYSTEM AND FITTING	19-GE1920310-PDA	Ø 15 – 108 mm
		INOXPRES, MECHANICAL JOINTS	ML 20PTB00014	Ø 15 – 108 mm

Campi di applicazione / Fields of application



Acqua potabile
Potable water

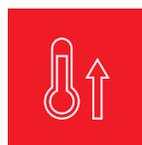

Riscaldamento
Heating



Raffrescamento
Cooling



Acque di processo
Process water



Aria compressa
Compressed air



Antincendio
Fire protection systems

inoxPRES O-ring EPDM

Nero | Black | Schwarz | Noir | Negro



Un marchio di qualità per i materiali a contatto con l'acqua potabile

A QUALITY BRAND FOR MATERIALS COMING IN CONTACT WITH DRINKING WATER

ICIM attesta che gli oggetti prodotti e/o commercializzati dall'Organizzazione **Raccorderie Metalliche S.p.A.:**

- Tubi e raccordi a pressare in acciaio inox (inoxPRES);
- Tubi e raccordi a pressare in rame e bronzo (aesPRES);
- Tubi e raccordi a pressare in cupronickel (marinePRES);
- Raccordi a saldare in acciaio inox;

sono idonei al contatto con acqua potabile destinata al consumo umano. (riferimento D.M. n.174 del 6 aprile 2004)



ICIM certifies that the products manufactured and/or marketed by **Raccorderie Metalliche S.p.A.:**

- Stainless steel pipes and pressfittings (inoxPRES);
- Copper and bronze pipes and pressfittings (aesPRES);
- Cupronickel pipes and pressfittings (marinePRES);
- Welding fittings in stainless steel;

are suitable for contact with drinking water intended for human consumption.

(Re: Ministerial Decree No. 174 dated 6 April 2004)

inoxPRES®



116/200 6 m
≤54 B 30 31
76÷108 B 30 32
TUBO IN ACCIAIO INOSSIDABILE

- STAINLESS STEEL PIPE
- EDELSTAHL ROHR
- TUBE EN ACIER INOXYDABLE
- TUBO DE ACERO INOXIDABLE

NORM: EN 10217-7 (DIN 17455) - EN 10312

Mat. Nr.: 1.4404 (AISI 316L) L=6 m
Crudo - Not annealed - Ungeglüht - Non-hypertrempé - Crudo

CODE	Dimensions mm x mm	∅ int mm	L m	kg/m	Volume l/m	Minimum package m	Bundle m	€/m
116015200	15 x 1,0	13	6	0,351	0,133	60	1014	-
116018200	18 x 1,0	16	6	0,426	0,201	60	1014	-
116022200	22 x 1,2	19,6	6	0,625	0,302	60	762	-
116028200	28 x 1,2	25,6	6	0,805	0,514	30	546	-
116035200	35 x 1,5	32	6	1,258	0,804	30	546	-
116042200	42 x 1,5	39	6	1,521	1,194	30	366	-
116054200	54 x 1,5	51	6	1,972	2,042	30	366	-
116076200	76,1 x 2,0	72,1	6	3,711	4,080	6	114	-
116088200	88,9 x 2,0	84,9	6	4,352	5,660	6	114	-
116108200	108 x 2,0	104	6	5,308	8,490	6	114	-

116/Oversize 6 m
B 30 36
TUBO IN ACCIAIO INOSSIDABILE

- STAINLESS STEEL PIPE
- EDELSTAHL ROHR
- TUBE EN ACIER INOXYDABLE
- TUBO DE ACERO INOXIDABLE

NORM: EN 10217-7 (DIN 17455) - EN 10312

Mat. Nr.: 1.4404 (AISI 316L) L=6 m
Crudo - Not annealed - Ungeglüht - Non-hypertrempé - Crudo

CODE	Dimensions mm x mm	∅ int mm	L m	kg/m	Volume l/m	Minimum package m	Bundle m	€/m
116139200*	139,7 x 2,0	135,7	6	6,896	14,460	6	60	-
116168200*	168,3 x 2,0	164,3	6	8,328	21,200	6	60	-
116139260	139,7 x 2,6	134,5	6	8,926	14,208	6	60	-
116168260	168,3 x 2,6	163,1	6	10,788	20,893	6	60	-

[*]: non certificato DVGW - not certified DVGW - keine Zertifizierung DVGW - pas certifié DVGW - DVGW no certificado

**116/203 3 m**

≤54 B 30 31

76÷108 B 30 32

**TUBO IN ACCIAIO
INOSSIDABILE**

- STAINLESS STEEL PIPE
- EDELSTAHL ROHR
- TUBE EN ACIER INOXYDABLE
- TUBO DE ACERO INOXIDABLE

NORM: EN 10217-7 (DIN 17455) - EN 10312**Mat. Nr.: 1.4404 (AISI 316L) L=3 m****Crudo - Not annealed - Ungelüht - Non-hypertrempé - Crudo**

CODE	Dimensions mm x mm	Ø int mm	L m	kg/m	Volume l/m	Minimum package m	€/m
116015203	15 x 1,0	13	3	0,351	0,133	60	-
116018203	18 x 1,0	16	3	0,426	0,201	60	-
116022203	22 x 1,2	19,6	3	0,625	0,302	36	-
116028203	28 x 1,2	25,6	3	0,805	0,514	30	-
116035203	35 x 1,5	32	3	1,258	0,804	18	-
116042203	42 x 1,5	39	3	1,521	1,194	12	-
116054203	54 x 1,5	51	3	1,972	2,042	12	-
116076203	76,1 x 2,0	72,1	3	3,711	4,080	6	-
116088203	88,9 x 2,0	84,9	3	4,352	5,660	6	-
116108203	108 x 2,0	104	3	5,308	8,490	6	-

**116/300 6 m**

≤54 B 30 31

76÷108 B 30 32

**TUBO IN ACCIAIO
INOSSIDABILE**

- STAINLESS STEEL PIPE
- EDELSTAHL ROHR
- TUBE EN ACIER INOXYDABLE
- TUBO DE ACERO INOXIDABLE

NORM: EN 10217-7 (DIN 17455) - EN 10312**Mat. Nr.: 1.4404 (AISI 316L) L=6 m****Ricotto - Annealed - Geglüht - Hypertrempé - Recocido**

CODE	Dimensions mm x mm	Ø int mm	L m	kg/m	Volume l/m	Minimum package m	Bundle m	€/m
116015300	15 x 1,0	13	6	0,351	0,133	60	1014	-
116018300	18 x 1,0	16	6	0,426	0,201	60	1014	-
116022300	22 x 1,2	19,6	6	0,625	0,302	60	762	-
116028300	28 x 1,2	25,6	6	0,805	0,514	30	546	-
116035300	35 x 1,5	32	6	1,258	0,804	30	546	-
116042300	42 x 1,5	39	6	1,521	1,194	30	366	-
116054300	54 x 1,5	51	6	1,972	2,042	30	366	-
116076300	76,1 x 2,0	72,1	6	3,711	4,080	6	114	-
116088300	88,9 x 2,0	84,9	6	4,352	5,660	6	114	-
116108300	108 x 2,0	104	6	5,308	8,490	6	114	-

**116/030 6 m****B 30 33****TUBO IN ACCIAIO INOSSIDABILE**

- STAINLESS STEEL PIPE
- EDELSTAHL ROHR
- TUBE EN ACIER INOXYDABLE
- TUBO DE ACERO INOXIDABLE

NORM: EN 10217-7 (DIN 17455) - EN 10312

Mat. Nr.: 1.4521 (AISI 444) L=6 m
Ricotto - Annealed - Geglüht - Hypertrempé - Recocido

CODE	Dimensions mm x mm	∅ int mm	L m	 kg/m	Volume l/m	Minimum package m	Bundle m	€/m
116015030	15 x 1,0	13	6	0,351	0,133	60	1014	-
116018030	18 x 1,0	16	6	0,426	0,201	60	1014	-
116022030	22 x 1,2	19,6	6	0,625	0,302	60	762	-
116028030	28 x 1,2	25,6	6	0,805	0,514	30	546	-
116035030	35 x 1,5	32	6	1,258	0,804	30	546	-
116042030	42 x 1,5	39	6	1,521	1,194	30	366	-
116054030	54 x 1,5	51	6	1,972	2,042	30	366	-

NOTA / NOTE

Per le specifiche certificazioni delle tubazioni in ogni singolo paese, vedere sito web raccorderiemetalliche.com

For pipes certification's details of each country, please check our website raccorderiemetalliche.com

Die für jedes einzelne Land spezifischen Zertifizierungen der Rohre finden Sie auf die Website raccorderiemetalliche.com

Pour toute certification de tubes dans chaque pays, voir le site internet raccorderiemetalliche.com

Para conocer las certificaciones específicas de las tuberías en cada país, consulte el sitio web raccorderiemetalliche.com

**114/200 6 m**

≤54 B 30 34

76÷108 B 30 35

**TUBO IN ACCIAIO
INOSSIDABILE**

- STAINLESS STEEL PIPE
- EDELSTAHL ROHR
- TUBE EN ACIER INOXYDABLE
- TUBO DE ACERO INOXIDABLE

NORM: EN 10217-7 (DIN 17455) - EN 10312
NOTE: Paese Italia - conforme al DM 174 per
 veicolazione acqua potabile;
 Italy country - according to DM 174 for
 drinking water transport;

Mat. Nr.: 1.4301 (AISI 304) L=6 m
Crudo - Not annealed - Ungeglüht - Non-hypertrempé - Crudo

CODE	Dimensions mm x mm	Ø int mm	L m	 kg/m	Volume l/m	Minimum package m	Bundle m	€/m
114015200	15 x 1,0	13	6	0,351	0,133	60	1014	-
114018200	18 x 1,0	16	6	0,426	0,201	60	1014	-
114022200	22 x 1,2	19,6	6	0,625	0,302	60	762	-
114028200	28 x 1,2	25,6	6	0,805	0,514	30	546	-
114035200	35 x 1,5	32	6	1,258	0,804	30	546	-
114042200	42 x 1,5	39	6	1,521	1,194	30	366	-
114054200	54 x 1,5	51	6	1,972	2,042	30	366	-
114076200	76,1 x 2,0	72,1	6	3,711	4,080	6	114	-
114088200	88,9 x 2,0	84,9	6	4,352	5,660	6	114	-
114108200	108 x 2,0	104	6	5,308	8,490	6	114	-

A 50 50

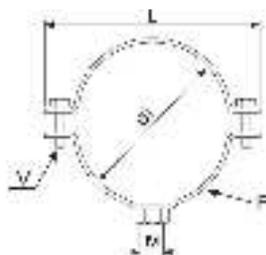

156

COLLARE PER TUBO INOXPRES

- CLAMP FOR INOXPRES PIPE
- ROHRSCHELLE FÜR INOXPRES ROHR
- COLLIER POUR TUBE INOXPRES
- ABRAZADERA PARA TUBO INOXPRES

MATERIAL: AISI 304 - 1.4301

NOTE: dado saldato con puntatura elettrica spot welded nut

CODE	DN mm	M	F Lg x Sp mm	V mm	L mm	g			€
156015304	15	M 8	20 x 2,5	M 6 x 20	48	52	1	50*	-
156308304	18	M 8	20 x 2,5	M 6 x 20	53,5	58	1	50*	-
156102304	22	M 8	20 x 2,5	M 6 x 20	58	62	1	50*	-
156304304	28	M 8	20 x 2,5	M 6 x 20	63,5	68	1	50*	-
156100304	35	M 8	20 x 2,5	M 6 x 20	70	76	1	50*	-
156114304	42	M 8	20 x 2,5	M 6 x 20	79	88	1	50*	-
156054304	54	M 8	20 x 2,5	M 6 x 25	94	102	1	50*	-
156212304	76,1	M 10	30 x 2,5	M 6 x 25	115	200	1	20*	-
156300304	88,9	M 10	30 x 2,5	M 6 x 25	128	221	1	20*	-
156108304	108	M 10	30 x 2,5	M 6 x 25	149	252	1	20*	-

[*] unità minima di vendita / minimum selling quantity

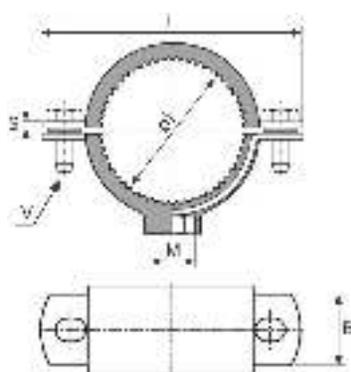

Conforme a
 Conform to
 Entsprechend
 Correspondant
 Conforme a la

DIN 4109

156/G

A 50 50

COLLARE GOMMA PER TUBO INOXPRES

- CLAMP WITH RUBBER FOR INOXPRES PIPE
- ROHRSCHELLE MIT GUMMIEINLAGE FÜR INOXPRES ROHR
- COLLIER DE FIXATION GARNITURE ISOPHONIQUE POUR TUBE INOXPRES
- ABRAZADERA ISOFÓNICA PARA TUBO INOXPRES

MATERIAL: AISI 304 - 1.4301

VULCANIZED RUBBER:

EPDM [-20° C/+120° C]
 durezza/hardness
 55 Shore

NOTE: dado saldato con puntatura elettrica spot welded nut

CODE	DN mm	M	V mm	B mm	S mm	L mm	g		€	
156150304G	15	M 8	M 6 x 20	20	2,5	58	72	1	50*	-
156308304G	18	M 8	M 6 x 20	20	2,5	58	76	1	50*	-
156102304G	22	M 8	M 6 x 20	20	2,5	63,5	86	1	50*	-
156304304G	28	M 8	M 6 x 20	20	2,5	70	94	1	50*	-
156100304G	35	M 8	M 6 x 20	20	2,5	79	112	1	50*	-
156114304G	42	M 8	M 6 x 20	20	2,5	85	120	1	50*	-
156112304G	54	M 8	M 6 x 25	20	2,5	97	142	1	50*	-
156212304G	76,1	M 10	M 6 x 25	30	2,5	128	308	1	10*	-
156300304G	88,9	M 10	M 6 x 25	30	2,5	148	346	1	10*	-
156108316G **	108	M 8 / 10	M 6 x 25	20	2	168	200	1	10*	-

[*] unità minima di vendita / minimum selling quantity

[**] Gomma staccabile - Detachable rubber - Abnehmbare Gummi - Caoutchouc amovible - Goma desmontable
 AISI 316 / 1.4401 (famiglia / family A 50 51)

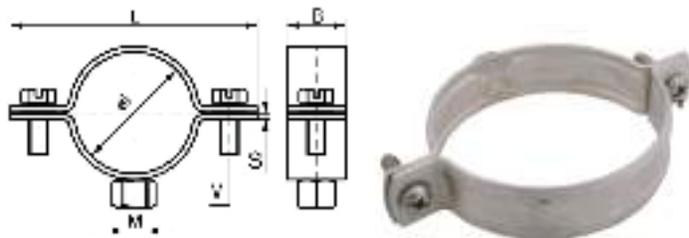
**156/316L****A 50 51****COLLARE FISSAGGIO TUBO - SERIE PESANTE**

- CLAMP - HEAVY SERIES
- ROHRSCHELLE - SCHWERE SERIE
- COLLIER DE FIXATION - SÉRIE LOURDE
- ABRAZADERA - SERIE PESADA

MATERIAL: AISI 316L - 1.4404**NOTE:** dado saldato con puntatura elettrica
spot welded nut

CODE	DN mm	M	V mm	B mm	S mm	L mm			€
156500316	139,7	M10	M 6 x 25	20	2,5	179	210	10*	-
156600316	168,3	M10	M 6 x 25	20	2,5	203	240	10*	-

[*] unità minima di vendita / minimum selling quantity

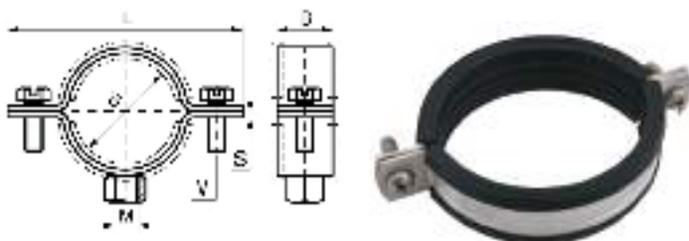
**156/316L G****A 50 51****COLLARE CON GOMMA - SERIE PESANTE**

- CLAMP WITH RUBBER - HEAVY SERIES
- ROHRSCHELLE MIT GUMMIEINLAGE - SCHWERE SERIE
- COLLIER DE FIXATION GARNITURE ISOPHONIQUE - SÉRIE LOURDE
- ABRAZADERA ISOFÓNICA - SERIE PESADA

MATERIAL: AISI 316L - 1.4404**VULCANIZED RUBBER:**EPDM [-20°
C/+120° C]
durezza/hardness
55 Shore**NOTE:** dado saldato con puntatura elettrica
spot welded nut

CODE	DN mm	M	V mm	B mm	S mm	L mm			€
156500316G	139,7	M10	M 6 x 25	20	2,5	179	250	10*	-
156600316G	168,3	M10	M 8 x 35	25	2,5	233	470	10*	-

[*] unità minima di vendita / minimum selling quantity

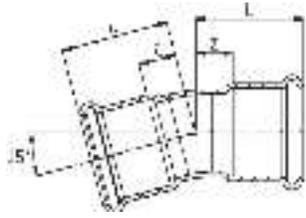

181/150

≤54 B 10 11
 76÷108 B 10 12

CURVA 15° FF

- 15° ELBOW FF
- BOGEN 15° II
- COUDE FF 15°
- CURVA 15° HH

MATERIAL: AISI 316L - 1.4404

O-RING: EPDM nero - black - Schwarz - noir - negro

CODE	De mm	L mm	Z mm				€
181015150	15	30	10	50	20	300	-
181018150	18	32	12	52	20	300	-
181022150	22	33	12	82	20	100	-
181028150	28	36	13	112	10	100	-
181035150	35	37	11	123	10	60	-
181042150	42	42	12	175	4	40	-
181054150	54	49	12	268	2	20	-
181076150C	76,1	87,5	32,5	777	2	2	-
181088150C	88,9	100,5	40,5	1032	2	2	-
181108150C	108	109,5	34,5	1412	2	2	-

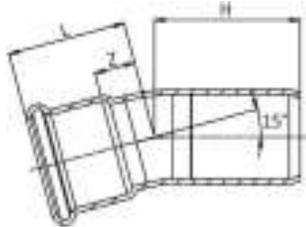

181/151

≤54 B 10 11
 76÷108 B 10 12

CURVA 15° MF

- 15° ELBOW MF
- BOGEN 15° IA
- COUDE MF 15°
- CURVA 15° HM

MATERIAL: AISI 316L - 1.4404

O-RING: EPDM nero - black - Schwarz - noir - negro

CODE	De mm	L mm	H mm	Z mm				€
181015151	15	30	40	10	50	20	300	-
181022151	22	33	41	12	82	20	100	-
181028151	28	36	43	13	112	10	100	-
181035151	35	37	41	11	133	10	60	-
181042151	42	42	55,5	12	165	4	40	-
181054151	54	49	55	13	293	2	20	-
181076151C	76,1	87,5	95,5	32,5	743	2	2	-
181088151C	88,9	100,5	108,5	40,5	988	2	2	-
181108151C	108	109,5	118	34,5	1332	2	2	-

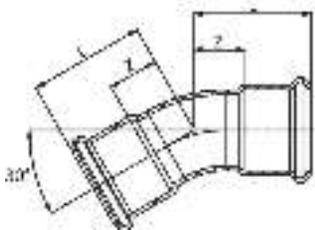
**181/300**

≤54 B 10 11
76÷108 B 10 12

CURVA 30° FF

- 30° ELBOW FF
- BOGEN 30° II
- COUDE FF 30°
- CURVA 30° HH

MATERIAL: AISI 316L - 1.4404**O-RING:** EPDM nero - black - Schwarz - noir - negro

CODE	De mm	L mm	Z mm				€
181015300	15	33	13	50	20	300	-
181018300	18	32	12	52	20	300	-
181022300	22	37	16	82	20	100	-
181028300	28	41	18	112	10	100	-
181035300	35	37	11	123	10	60	-
181042300	42	44	14	175	4	40	-
181054300	54	52	17	268	2	20	-
181076300	76,1	100	55	900	2	2	-
181088300	88,9	115	64	1250	2	2	-
181108300	108	127	68	1700	2	2	-

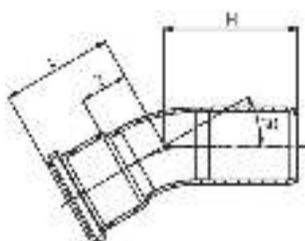
**181/301**

≤54 B 10 11
76÷108 B 10 12

CURVA 30° MF

- 30° ELBOW MF
- BOGEN 30° IA
- COUDE MF 30°
- CURVA 30° HM

MATERIAL: AISI 316L - 1.4404**O-RING:** EPDM nero - black - Schwarz - noir - negro

CODE	De mm	L mm	H mm	Z mm				€
181015301	15	33	43	13	50	20	300	-
181022301	22	37	46	16	82	20	100	-
181028301	28	41	48	18	112	10	100	-
181035301	35	37	46	11	133	10	60	-
181042301	42	44	54	14	195	4	40	-
181054301	54	52	63	17	293	2	20	-
181076301	76,1	100	108	55	900	2	2	-
181088301	88,9	115	123	64	1250	2	2	-
181108301	108	127	136	68	1700	2	2	-

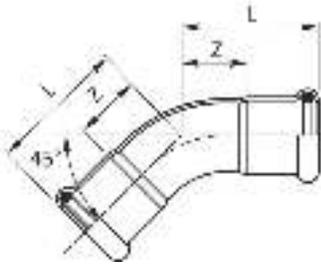

181/450

CURVA 45° FF

- 45° ELBOW FF
- BOGEN 45° II
- COUDE FF 45°
- CURVA 45° HH

MATERIAL: AISI 316L - 1.4404

O-RING: EPDM nero - black - Schwarz - noir - negro

≤54 **B 10 11**
 76÷108 **B 10 12**
 ≥139 **B 10 17**

CODE	De mm	Radius	L mm	Z mm				€
181015450	15	1,5 De	36	16	50	20	300	-
181018450	18	1,5 De	37	17	64	20	300	-
181022450	22	1,5 De	41	20	82	20	100	-
181028450	28	1,5 De	47	24	112	10	100	-
181035450	35	1,2 De	43	17	127	10	60	-
181042450	42	1,2 De	51	21	177	4	40	-
181054450	54	1,2 De	62	30	273	2	20	-
181076450	76,1	1,2 De	131,5	76,5	900	2	2	-
181088450	88,9	1,2 De	144	84	1250	2	2	-
181108450	108	1,2 De	169	94	1700	2	2	-
181139450	139,7	-	203	108	3052	1	1	-
181168450	168,3	-	252	139	4556	1	1	-

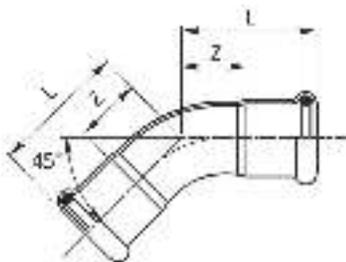

181/450 C

CURVA 45° FF - RAGGIO STRETTO

- 45° ELBOW FF - SHORT RADIUS
- BOGEN 45° II - KURZER RADIUS
- COUDE FF 45° - RAYON COURT
- CURVA 45° HH - RADIO CORTO

MATERIAL: AISI 316L - 1.4404

O-RING: EPDM nero - black - Schwarz - noir - negro

B 10 11

CODE	De mm	Radius	L mm	Z mm				€
181015450C	15	1,2 De	27,5	7,5	39	20	400	-
181018450C	18	1,2 De	29,5	9,5	48	20	300	-
181022450C	22	1,2 De	32	11	63	20	200	-
181028450C	28	1,2 De	37	14	90	10	100	-

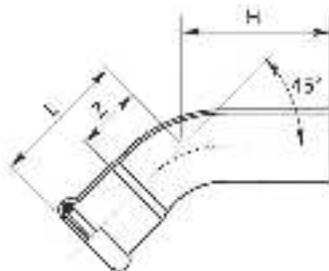
**181/451**

≤54 B 10 11

76÷108 B 10 12

≥139 B 10 17

CURVA 45° MF

- 45° ELBOW MF
- BOGEN 45° IA
- COUDE MF 45°
- CURVA 45° HM

MATERIAL: AISI 316L - 1.4404**O-RING:** EPDM nero - black - Schwarz - noir - negro

CODE	De mm	Radius	L mm	H mm	Z mm				€
181015451	15	1,5 De	36	49	16	50	20	300	-
181018451	18	1,5 De	37	43	17	64	20	300	-
181022451	22	1,5 De	41	48	20	82	20	100	-
181028451	28	1,5 De	47	54,5	22	112	10	100	-
181035451	35	1,2 De	43	57,5	17	132	10	60	-
181042451	42	1,2 De	51	72	21	196	4	40	-
181054451	54	1,2 De	62	82	26	296	2	20	-
181076451	76,1	1,2 De	131,5	149	76,5	900	2	2	-
181088451	88,9	1,2 De	144	159	84	1250	2	2	-
181108451	108	1,2 De	169	199	94	1700	2	2	-
181139451	139,7	-	203	210	108	2947	1	1	-
181168451	168,3	-	252	261	139	4346	1	1	-

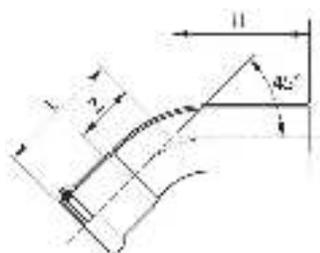
**181/451 C**

B 10 11

CURVA 45° MF - RAGGIO STRETTO

- 45° ELBOW MF - SHORT RADIUS
- BOGEN 45° IA - KURZER RADIUS
- COUDE MF 45° - RAYON COURT
- CURVA 45° HM - RADIO CORTO

MATERIAL: AISI 316L - 1.4404**O-RING:** EPDM nero - black - Schwarz - noir - negro

CODE	De mm	Radius	L mm	H mm	Z mm				€
181015451C	15	1,2 De	27,5	36	7,5	38	20	400	-
181018451C	18	1,2 De	29,5	38	9,5	47	20	300	-
181022451C	22	1,2 De	32	42	11	63	20	200	-
181028451C	28	1,2 De	37	46	14	90	10	100	-

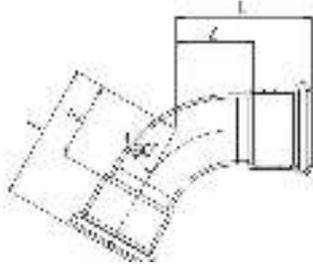

181/600

≤54 B 10 11
76÷108 B 10 12

CURVA 60° FF

- 60° ELBOW FF
- BOGEN 60° II
- COUDE FF 60°
- CURVA 60° HH

MATERIAL: AISI 316L - 1.4404

O-RING: EPDM nero - black - Schwarz - noir - negro

CODE	De mm	L mm	Z mm	g			€
181015600	15	30,5	10,5	41	20	300	-
181018600	18	32	12	50	20	300	-
181022600	22	36	15	68	20	100	-
181028600	28	42	19	98	10	100	-
181035600	35	50	24	141	10	60	-
181042600	42	59	29	204	4	40	-
181054600	54	72,5	37	313	2	20	-
181076600	76,1	146,5	91,5	1178	2	2	-
181088600	88,9	162	102	1517	2	2	-
181108600	108	190	115	2194	2	2	-

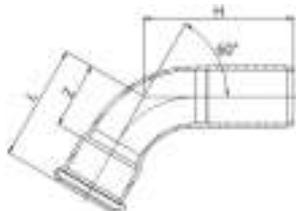

181/601

≤54 B 10 11
76÷108 B 10 12

CURVA 60° MF

- 60° ELBOW MF
- BOGEN 60° IA
- COUDE MF 60°
- CURVA 60° HM

MATERIAL: AISI 316L - 1.4404

O-RING: EPDM nero - black - Schwarz - noir - negro

CODE	De mm	L mm	H mm	Z mm	g		€	
181015601	15	30,5	39	10,5	40	20	300	-
181018601	18	32	41	12	50	20	300	-
181022601	22	36	46	15	68	20	100	-
181028601	28	42	51	19	98	10	100	-
181035601	35	50	64	24	149	10	60	-
181042601	42	59	80	29	220	4	40	-
181054601	54	72,5	92,5	37	332	2	20	-
181076601	76,1	146,5	164	91,5	1179	2	2	-
181088601	88,9	162	177	102	1503	2	2	-
181108601	108	190	205	115	2148	2	2	-

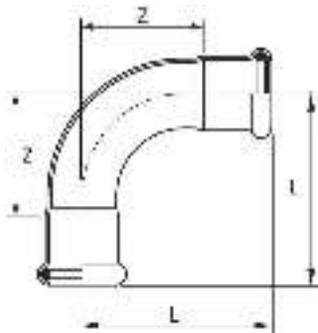
**181/900****CURVA 90° FF**

- 90° ELBOW FF
- BOGEN 90° II
- COUDE FF 90°
- CURVA 90° HH

MATERIAL: AISI 316L - 1.4404**O-RING:** EPDM nero - black - Schwarz - noir - negro

≤54 B 10 11

76÷108 B 10 12

≥139 B 10 17

CODE	De mm	Radius	L mm	Z mm	g			€
181015900	15	1,5 De	50	30	58	20	300	-
181018900	18	1,5 De	54	34	72	20	200	-
181022900	22	1,5 De	60	39	102	10	100	-
181028900	28	1,5 De	73	50	143	10	50	-
181035900	35	1,2 De	68	42	162	5	50	-
181042900	42	1,2 De	80	50	231	2	30	-
181054900	54	1,2 De	100	64	367	2	18	-
181076900	76,1	1,2 De	160	105	1150	2	2	-
181088900	88,9	1,2 De	182	122	1580	2	2	-
181108900	108	1,2 De	220	145	2250	2	2	-
181139900	139,7	-	314	219	4082	1	1	-
181168900	168,3	-	386	273	6059	1	1	-

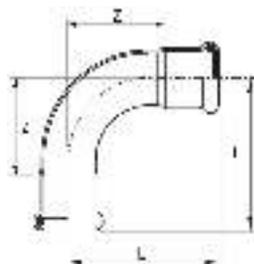
**181/900 C****CURVA 90° FF - RAGGIO STRETTO**

- 90° ELBOW FF - SHORT RADIUS
- BOGEN 90° II - KURZER RADIUS
- COUDE FF 90° - RAYON COURT
- CURVA 90° HH - RADIO CORTO

MATERIAL: AISI 316L - 1.4404**O-RING:** EPDM nero - black - Schwarz - noir - negro

B 10 11

CODE	De mm	Radius	L mm	Z mm	g			€
181015900C	15	1,2 De	38	18	46	20	400	-
181018900C	18	1,2 De	41,5	21,5	58	20	300	-
181022900C	22	1,2 De	47	26	78	10	150	-
181028900C	28	1,2 De	56	33	116	10	100	-

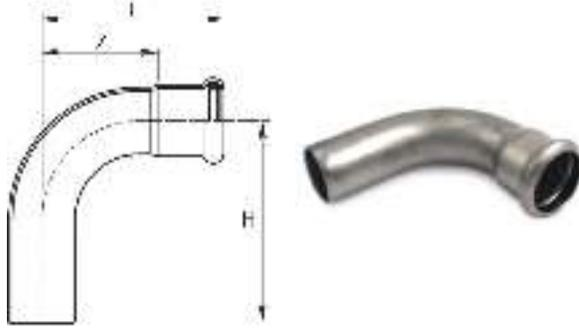

181/901

≤54 **B 10 11**
76÷108 **B 10 12**
≥139 **B 10 17**

CURVA 90° MF - RAGGIO STRETTO

- 90° ELBOW MF - SHORT RADIUS
- BOGEN 90° IA - KURZER RADIUS
- COUDE MF 90° - RAYON COURT
- CURVA 90° HM - RADIO CORTO

MATERIAL: AISI 316L - 1.4404

O-RING: EPDM nero - black - Schwarz - noir - negro

CODE	De mm	Radius	L mm	H mm	Z mm	g			€
181015901	15	1,5 De	50	63	30	58	20	300	-
181018901	18	1,5 De	54	63	34	72	20	200	-
181022901	22	1,5 De	60	71	39	102	10	100	-
181028901	28	1,5 De	73	81	50	143	10	50	-
181035901	35	1,2 De	68	82	42	176	5	50	-
181042901	42	1,2 De	80	101	50	253	2	30	-
181054901	54	1,2 De	100	120	64	390	2	18	-
181076901	76,1	1,2 De	160	180	105	1150	2	2	-
181088901	88,9	1,2 De	182	197	122	1580	2	2	-
181108901	108	1,2 De	220	236	145	2250	2	2	-
181139901	139,7	-	314	322	219	3984	1	1	-
181168901	168,3	-	386	395	273	5991	1	1	-



181/901 C

B 10 11

CURVA 90° MF - RAGGIO STRETTO

- 90° ELBOW MF - SHORT RADIUS
- BOGEN 90° IA - KURZER RADIUS
- COUDE MF 90° - RAYON COURT
- CURVA 90° HM - RADIO CORTO

MATERIAL: AISI 316L - 1.4404

O-RING: EPDM nero - black - Schwarz - noir - negro

CODE	De mm	Radius	L mm	H mm	Z mm	g			€
181015901C	15	1,2 De	38	48	18	46	20	400	-
181018901C	18	1,2 De	41,5	48,5	21,5	56	20	300	-
181022901C	22	1,2 De	47	57	26	79	10	150	-
181028901C	28	1,2 De	56	64	33	115	10	100	-

Oversize!

AISI 316L Stainless Steel

5"-6"

Ø 139,7

Ø 168,3

DVGW **inoxPRES**



inoxPRES
Ø 168,3
316-L
14 1800



B1011

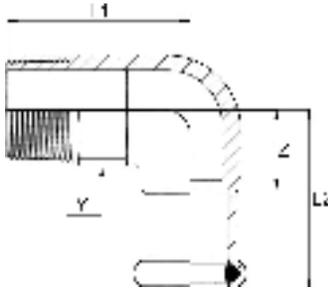

197

GOMITO MISTO 90° FILETTO M

- ELBOW ADAPTER 90° WITH MALE THREAD
- ÜBERGANGSWINKEL 90° AG
- EQUERRE 90° AVEC FILETAGE M
- CODO MACHO

MATERIAL: AISI 316L - 1.4404
O-RING: EPDM nero - black - Schwarz - noir - negro
THREAD: EN 10226-1 (ex ISO 7/1)

CODE	De x R mm x inch	L1 mm	L2 mm	Z mm	Y mm	g	kg	box	€
197102015	15 x 1/2"	37	36	16	22	87	10	200	-
197102018	18 x 1/2"	37	36	16	22	93	10	200	-
197102022	22 x 1/2"	41	37	16	22	106	10	100	-
197304022	22 x 3/4"	44	43	22	28	164	10	100	-
197304028	28 x 3/4"	44	45	22	28	195	5	50	-
197100028	28 x 1"	56	50	27	36	332	5	50	-
197114035	35 x 1 1/4"	63	76,5	50,5	46	476	5	40	-
197112042	42 x 1 1/2"	67,5	80	50	50	533	2	30	-
197200054	54 x 2"	78,5	91,5	56	65	899	2	20	-

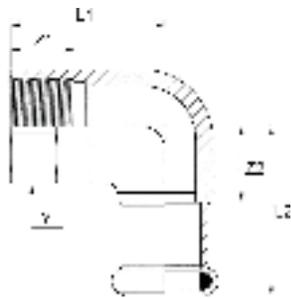

198

GOMITO MISTO 90° FILETTO F

- ELBOW ADAPTER 90° WITH FEMALE THREAD
- ÜBERGANGSWINKEL 90° IG
- EQUERRE 90° AVEC FILETAGE F
- CODO HEMBRA

MATERIAL: AISI 316L - 1.4404
O-RING: EPDM nero - black - Schwarz - noir - negro
THREAD: EN 10226-1 (ex ISO 7/1)

B1011

CODE	De x Rp mm x inch	L1 mm	L2 mm	Z1 mm	Z2 mm	Y mm	g	kg	box	€
198102015	15 x 1/2"	33	36	15	16	24	92	10	100	-
198304015	15 x 3/4"	38	42	19	22	30	139	10	100	-
198102018	18 x 1/2"	33	36	15	16	24	99	10	100	-
198102022	22 x 1/2"	33	37	15	16	24	106	10	100	-
198304022	22 x 3/4"	38	43	19	22	30	154	10	100	-
198102028	28 x 1/2"	33	39	15	16	24	126	5	50	-
198100028	28 x 1"	48	50	21	27	38	309	5	50	-
198114035	35 x 1 1/4"	48	70,5	21	50,5	46	379	5	40	-
198112042	42 x 1 1/2"	51	80	21	50	50	390	2	20	-
198200054	54 x 2"	66	92	26	56	65	749	2	10	-

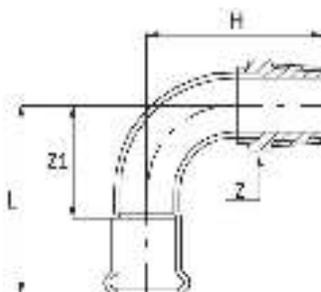

186

CURVA FILETTATA 90° FILETTO M

- 90° ELBOW MALE BSP
- BOGEN 90° MIT AG
- COUDE 90° AVEC FILETAGE M
- CODO A 90° MH

MATERIAL: AISI 316L - 1.4404

O-RING: EPDM nero - black - Schwarz - noir - negro

THREAD: EN 10226-1 (ex ISO 7/1)

CODE	De x R mm x inch	Radius	L mm	Z mm	Z1 mm	H mm				€
186102015	15 x 1/2"	1,5 D	50	24	30	54	85	20	300	-
186102018	18 x 1/2"	1,5 D	54	24	34	59	98	20	200	-
186304022	22 x 3/4"	1,5 D	60	30	39	69	143	10	100	-
186100028	28 x 1"	1,5 D	73	36	50	80	218	10	50	-
186100035	35 x 1"	1,2 D	68	41	42	85	277	5	50	-
186114035	35 x 1 1/4"	1,2 D	68	46	42	89	324	5	40	-
186114042	42 x 1 1/4"	1,2 D	80	50	50	107	438	2	20	-
186112042	42 x 1 1/2"	1,2 D	80	55	50	107	340	2	20	-
186200054	54 x 2"	1,2 D	100	65	65	141,5	515	2	12	-



186/R

CURVA 90° CON DADO FOLLE

- 90° ELBOW WITH VALVE CONNECTOR
- BOGEN 90° MIT ANSCHLUSSVERSCHRAUBUNG
- COUDE 90° AVEC ÉCROU LIBRE
- CODO A 90° CON TUERCA LOCA

MATERIAL: AISI 316L - 1.4404

O-RING: EPDM nero - black - Schwarz - noir - negro

GASKET: [*]: EPDM nero - black - Schwarz - noir - negro

THREAD: ISO 228/1 (ex DIN 259)

CODE	De x G mm x inch	L mm	H mm	Z mm	Z1 mm	Z2 mm				€
186042134R	42 x 1 3/4"	80	77,5	75	50	67,5	345	1	16	-
186054238R	54 x 2 3/8"	100	96	75	64,5	83,5	589	1	10	-

≤54 B1011

76÷108 B1012

≥139 B1017

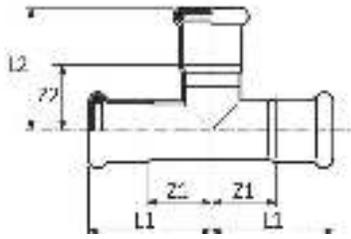

182

“T”

- EQUAL TEE
- T-STÜCK
- TÉ ÉGAL
- TE IGUAL HHH

MATERIAL: AISI 316L - 1.4404
O-RING: EPDM nero - black - Schwarz - noir - negro

CODE	De mm	L1 mm	L2 mm	Z1 mm	Z2 mm	g			€
182015000	15	34	39	14	19	67	20	200	-
182018000	18	37	41	16	21	80	20	100	-
182022000	22	39	45	18	24	106	10	100	-
182028000	28	44	50	21	27	145	10	50	-
182035000	35	51	57	25	31	201	4	32	-
182042000	42	59	65	28	35	260	4	20	-
182054000	54	70	77	34	42	404	2	12	-
182076000	76,1	108	118	53	63	1275	2	2	-
182088000	88,9	132	131	72	71	1535	2	2	-
182108000	108	155	159	74	84	2115	2	2	-
182139000	139,7	197	222	102	127	4129	1	1	-
182168000	168,3	257	268	144	155	6321	1	1	-

B1011

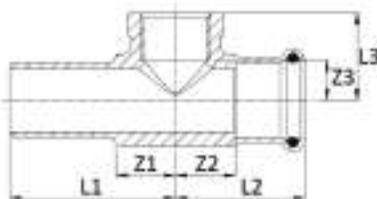

189/MF

“T” CON DERIVAZIONE FILETTO FEMMINA ED ESTREMITA MASCHIO

- BRANCH TEE FEMALE BSP OUTLET WITH PLUG-IN END
- T-STÜCK MIT ABGANG IG UND EINSTECKENDE
- TÉ MIXTE AVEC FILETAGE FEMELLE ET EMBOUT MÂLE
- TE HEMBRA ROSCADA CON EXTREMO INSERTABLE

MATERIAL: AISI 316L - 1.4404
O-RING: EPDM nero - black - Schwarz - noir - negro
THREAD: EN 10226-1 (ex ISO 7/1)

CODE	De x Rp x De mm x inch x mm	L1 mm	L2 mm	L3 mm	Z1 mm	Z2 mm	Z3 mm	g			€
189102022MF	22 x 1/2" x 22	50	39	26	18	18	12	161	5	50	-
189304028MF	28 x 3/4" x 28	58	44	30	21	21	14	227	5	50	-

B1011



189/M

“T” CON DERIVAZIONE FILETTO M

- BRANCH TEE MALE BSP OUTLET
- T-STÜCK MIT ABGANG AG
- TÉ MIXTE AVEC FILETAGE M
- TE ROSCADO MACHO

MATERIAL: AISI 316L - 1.4404
O-RING: EPDM nero - black - Schwarz - noir - negro
THREAD: EN 10226-1 (ex ISO 7/1)

CODE	De x R x De mm x inch x mm	L1 mm	L2 mm	Z1 mm	Z2 mm	g			€
189102015M	15 x 1/2" x 15	34,5	34	14,5	20	80	20	100	-



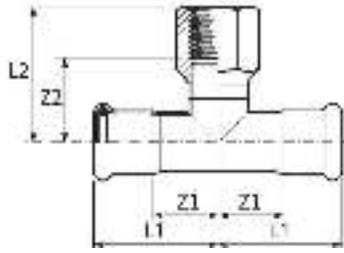

189

"T" CON DERIVAZIONE
FILETTO F

- BRANCH TEE FEMALE BSP OUTLET
- T-STÜCK MIT ABGANG IG
- TÉ MIXTE AVEC FILETAGE F
- TE HEMBRA ROSCADA

MATERIAL: AISI 316L - 1.4404

O-RING: EPDM nero - black - Schwarz - noir - negro

THREAD: EN 10226-1 (ex ISO 7/1)

≤54 B 10 11

76÷108 B 10 12

≥139 B 10 17

CODE	De x Rp x De mm x inch x mm	L1 mm	L2 mm	Z1 mm	Z2 mm				€
189102015*	15 x 1/2" x 15	36,5	22,5	16,5	8,5	117	20	100	-
189102018*	18 x 1/2" x 18	36	24	16	10	128	20	100	-
189304018*	18 x 3/4" x 18	38,5	26	18,5	11	147	20	100	-
189102022*	22 x 1/2" x 22	39	26	18	12	159	10	100	-
189304022*	22 x 3/4" x 22	41,5	30	20,5	14	184	10	100	-
189102028*	28 x 1/2" x 28	44	29	21	15	217	10	50	-
189304028*	28 x 3/4" x 28	44	30	21	14	221	10	50	-
189100028*	28 x 1" x 28	44	34	21	16	266	5	50	-
189102035	35 x 1/2" x 35	51	51	25	36	197	5	50	-
189304035	35 x 3/4" x 35	51	54	25	37	205	5	40	-
189100035	35 x 1" x 35	51	56	25	37	282	5	40	-
189102042	42 x 1/2" x 42	59	54	29	39	271	4	32	-
189304042	42 x 3/4" x 42	59	57	29	41	277	4	32	-
189100042	42 x 1" x 42	59	60	29	41	346	4	32	-
189102054	54 x 1/2" x 54	70	61	34	46	377	2	14	-
189304054	54 x 3/4" x 54	70	64	34	48	391	2	14	-
189200054	54 x 2" x 54	70	81	34	55	838	2	10	-
189304076	76,1 x 3/4" x 76,1	108	77	53	60	1040	2	2	-
189100076	76,1 x 1" x 76,1	108	79	53	60	1063	2	2	-
189200076	76,1 x 2" x 76,1	108	93	53	67	1495	2	2	-
189304088	88,9 x 3/4" x 88,9	132	84	72	67	1255	2	2	-
189200088	88,9 x 2" x 88,9	132	100	72	74	1720	2	2	-
189304108	108 x 3/4" x 108	155	94	74	77	1700	2	2	-
189200108	108 x 2" x 108	155	110	74	84	2160	2	2	-
189100139	139,7 x 1" x 139,7	197	107	102	88	3126	1	1	-
189200139	139,7 x 2" x 139,7	197	130	102	104	3623	1	1	-
189100168	168,3 x 1" x 168,3	257	120	144	101	4827	1	1	-
189200168	168,3 x 2" x 168,3	257	143	144	117	5325	1	1	-

[*] senza saldatura - seamless - nahtlos - sans soudure - sin soldadura

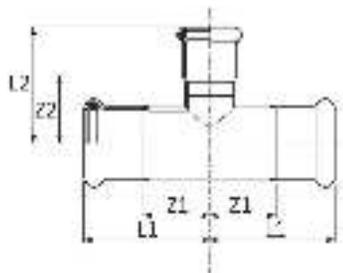
192
"T" RIDOTTO

- REDUCING TEE
- T-STÜCK MIT REDUZIERTEM ABGANG
- TÉ RÉDUIT
- TE REDUCIDA HHH

MATERIAL: AISI 316L - 1.4404

O-RING: EPDM nero - black - Schwarz - noir - negro

≤54 B 10 11
76÷108 B 10 12
≥139 B 10 17

CODE	De mm	L1 mm	L2 mm	Z1 mm	Z2 mm				€
192018015	18 x 15 x 18	36,5	41	15,5	21	80	20	100	-
192022015	22 x 15 x 22	39	43	18	23	95	10	100	-
192022018	22 x 18 x 22	39	44	18	23	98	10	100	-
192028015	28 x 15 x 28	44	46	21	26	126	10	50	-
192028018	28 x 18 x 28	44	46	21	26	130	10	50	-
192028022	28 x 22 x 28	44	47	21	26	135	10	50	-
192035015	35 x 15 x 35	51	49	25	29	158	5	50	-
192035018	35 x 18 x 35	51	50	25	30	163	5	50	-
192035022	35 x 22 x 35	51	51	25	30	167	5	50	-
192035028	35 x 28 x 35	51	54	25	31	171	5	35	-
192042018	42 x 18 x 42	59	54	29	34	232	4	20	-
192042022	42 x 22 x 42	59	54	29	33	237	4	20	-
192042028	42 x 28 x 42	59	57	29	34	243	4	20	-
192042035	42 x 35 x 42	59	61	29	35	272	4	20	-
192054018	54 x 18 x 54	70	61	54	41	335	2	16	-
192054022	54 x 22 x 54	70	62	34	41	340	2	16	-
192054028	54 x 28 x 54	70	65	34	42	345	2	16	-
192054035	54 x 35 x 54	70	68	34	42	361	2	16	-
192054042	54 x 42 x 54	70	72	34	42	376	2	16	-
192076022	76,1 x 22 x 76,1	108	74	53	53	995	2	2	-
192076028	76,1 x 28 x 76,1	108	77	53	54	1015	2	2	-
192076035	76,1 x 35 x 76,1	108	80	53	54	1025	2	2	-
192076042	76,1 x 42 x 76,1	108	84	53	54	1045	2	2	-
192076054	76,1 x 54 x 76,1	108	90	53	55	1065	2	2	-
192088022	88,9 x 22 x 88,9	132	81	72	60	1220	2	2	-
192088028	88,9 x 28 x 88,9	132	84	72	61	1225	2	2	-
192088035	88,9 x 35 x 88,9	132	88	72	62	1245	2	2	-
192088042	88,9 x 42 x 88,9	132	91	72	61	1255	2	2	-
192088054	88,9 x 54 x 88,9	132	97	72	62	1280	2	2	-
192088076	88,9 x 76,1 x 88,9	132	125	72	70	1485	2	2	-
192108022	108 x 22 x 108	155	91	74	70	1665	2	2	-
192108028	108 x 28 x 108	155	94	74	71	1670	2	2	-
192108035	108 x 35 x 108	155	97	74	71	1775	2	2	-
192108042	108 x 42 x 108	155	101	74	71	1865	2	2	-
192108054	108 x 54 x 108	155	107	74	72	1925	2	2	-
192108076	108 x 76,1 x 108	155	135	74	80	1930	2	2	-
192108088	108 x 88,9 x 108	155	141	74	81	1965	2	2	-

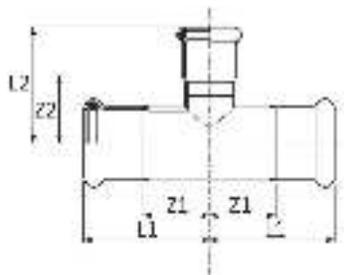

192

"T" RIDOTTO

- REDUCING TEE
- T-STÜCK MIT REDUZIERTEM ABGANG
- TÉ RÉDUIT
- TE REDUCIDA HHH

MATERIAL: AISI 316L - 1.4404

O-RING: EPDM nero - black - Schwarz - noir - negro

≤54 B 10 11

76÷108 B 10 12

≥139 B 10 17

CODE	De mm	L1 mm	L2 mm	Z1 mm	Z2 mm	g			€
192139035	139,7 x 35 x 139,7	197	117	102	91	3083	1	1	-
192139076	139,7 x 76,1 x 139,7	197	155	102	100	3340	1	1	-
192139088	139,7 x 88,9 x 139,7	197	164	102	104	3435	1	1	-
192139108	139,7 x 108 x 139,7	197	180	102	105	3631	1	1	-
192168035	168,3 x 35 x 168,3	257	130	144	104	4784	1	1	-
192168076	168,3 x 76,1 x 168,3	257	169	144	114	5050	1	1	-
192168088	168,3 x 88,9 x 168,3	257	178	144	118	5146	1	1	-
192168108	168,3 x 108 x 168,3	257	194	144	119	5340	1	1	-
192168139	168,3 x 139,7 x 168,3	257	221	144	126	5681	1	1	-

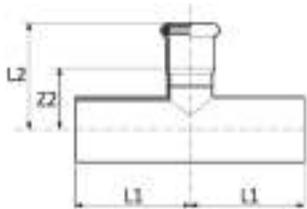

188

"T" RIDOTTO MFM

- REDUCING TEE MFM
- T-STÜCK MIT REDUZIERTEM ABGANG A/I/A
- TÉ RÉDUIT MFM
- TE REDUCIDA MHM

MATERIAL: AISI 316L - 1.4404

O-RING: EPDM nero - black - Schwarz - noir - negro

B 10 11

CODE	De mm	L1 mm	L2 mm	Z2 mm	g			€
188028022	28 x 22 x 28	52,5	47	26	138	10	50	-
188035022	35 x 22 x 35	60	50,5	29,5	185	5	35	-
188035028	35 x 28 x 35	60	53,5	30,5	193	5	35	-
188042028	42 x 28 x 42	69	57	34	256	4	20	-
188054028	54 x 28 x 54	73,5	64,5	41,5	334	2	16	-

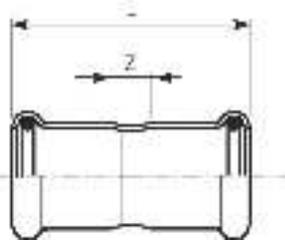

183/000

MANICOTTO

- COUPLING
- MUFFE
- MANCHON
- MANGUITO HH

MATERIAL: AISI 316L - 1.4404

O-RING: EPDM nero - black - Schwarz - noir - negro

≤54 B 10 11
76÷108 B 10 12
≥139 B 10 17

CODE	De mm	L mm	Z mm				€
183015000	15	49	9	35	20	500	-
183018000	18	50	10	42	20	300	-
183022000	22	53	11	54	20	200	-
183028000	28	56	10	71	10	150	-
183035000	35	63	10	97	10	100	-
183042000	42	72	12	136	4	60	-
183054000	54	83	13	198	2	24	-
183076000	76,1	142	32	635	4	4	-
183088000	88,9	166	46	765	4	4	-
183108000	108	203	41	1170	2	2	-
183139000	139,7	250	60	2031	1	1	-
183168000	168,3	300	74	2936	1	1	-

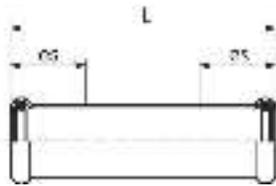

183/001

MANICOTTO PASSANTE

- SLIP COUPLING
- SCHIEBEMUFFE
- MANCHON LONG
- MANGUITO SIN TOPE

MATERIAL: AISI 316L - 1.4404

O-RING: EPDM nero - black - Schwarz - noir - negro

≤54 B 10 11
76÷108 B 10 12

CODE	De mm	L mm	es mm				€
183015001	15	69	25	56	20	200	-
183018001	18	73	25	65	20	200	-
183022001	22	79	25	85	20	100	-
183028001	28	88,5	30	118	10	100	-
183035001	35	102,5	30	141	10	50	-
183042001	42	117,5	40	234	4	40	-
183054001	54	139	40	321	2	20	-
183076001	76,1	230	60	940	2	2	-
183088001	88,9	260	70	1240	2	2	-
183108001	108	310	80	1835	2	2	-

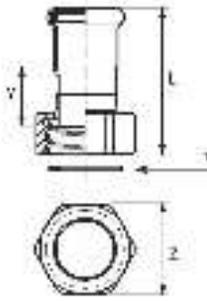
**183/002****MANICOTTO CON DADO FOLLE**

- VALVE CONNECTOR
- ANSCHLUSSVERSCHRÄUBUNG
- RACCORD ÉCROU LIBRE
- RÁCOR DOS PIEZAS

MATERIAL: AISI 316L – 1.4404**O-RING:** EPDM nero – black – Schwarz – noir – negro**GASKET:** [*]: EPDM nero – black – Schwarz – noir – negro**THREAD:** ISO 228/1 (ex DIN 259)

CODE	De x G mm x inch	L mm	Z mm	Y mm	Gasket mm				€
183015012	15 x 1/2"	48,5	27	23	18x10 thk 2,5	83	10	250	-
183015002	15 x 3/4"	50	30	23	24x14 thk 2,5	66	10	250	-
183018012	18 x 1/2"	49	27	23,5	18x10 thk 2,5	91	10	250	-
183018002	18 x 3/4"	50	30	23,5	24x14 thk 2,5	65	10	250	-
183022012	22 x 3/4"	50	30	19,5	24x14 thk 2,5	78	10	200	-
183022002	22 x 1"	52	36	23	30x20 thk 2,5	87	10	200	-
183028012	28 x 1"	52	36	19,5	30x20 thk 2,5	105	10	150	-
183028002	28 x 1"1/4	57	46	25	39x27 thk 2,5	136	10	150	-
183028022	28 x 1"1/2	59	52	22,5	44,5x27 thk 2,5	197	10	60	-
183035012	35 x 1"1/4	57,5	46	20,5	39x27 thk 2,5	163	4	60	-
183035002	35 x 1"1/2	63	52	26	44,5x34 thk 2,5	186	4	60	-
183042022	42 x 1"1/2	63,5	52	21	44,5x34 thk 2,5	217	2	30	-
183042012	42 x 1"3/4	68	58	27	50,5x40 thk 2,5	223	2	30	-
183042002	42 x 2"	68	64	27	56x42 thk 2,5	266	2	30	-
183054022	54 x 2"	72	67	23	56x42 thk 2,5	301	2	20	-
183054012	54 x 2"3/8	77	75	30	65,5x53,5 thk 3	375	2	20	-
183054002	54 x 2"1/2	77	81	30	71,5x53 thk 3	439	2	20	-

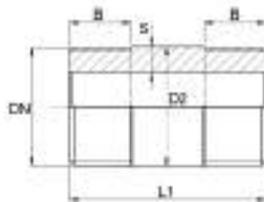
**530/I Inoxpres****VITE DI ALLUNGAMENTO (BARILOTTO)**

- BARREL NIPPLE
- ROHRDOPPELNIPPEL
- MAMELON
- ENTRONQUE DOBLE

MATERIAL: AISI 316 – 1.4401**THREAD:** ISO 228/1 (ex DIN 259)

CODE	DN inch	L1 mm	S mm	B mm	D2 mm				€
530100070I	1"	70	7,9	22	33,8	347	1	10	-
530114070I	1"1/4	70	9,2	22	42,4	522	1	8	-
530112070I	1"1/2	70	8,7	22	48,3	586	1	8	-
530134070I	1"3/4	70	8	22	54	635	1	6	-
530238070I	2"3/8	70	10	22	70	1026	1	4	-

B 10 11

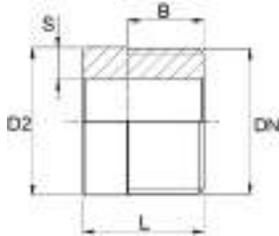

600/I Inoxpres

TRONCHETTO

- WELDING NIPPLE
- ANSCHWEISSENDE
- DEMI MAMELON
- ENTRONQUE

MATERIAL: AISI 316 - 1.4401
THREAD: ISO 228/1 (ex DIN 259)

CODE	DN inch	L mm	S mm	B mm	D2 mm	g	kg	box	€
60010035I	1"	35	7,9	22	33,8	174	1	30	-
600114035I	1 1/4"	35	9,2	22	42,4	261	1	20	-
600112035I	1 1/2"	35	8,7	22	48,3	293	1	10	-
600134035I	1 3/4"	35	8	22	54	318	1	10	-
600238035I	2 3/8"	35	10	22	70	513	1	10	-

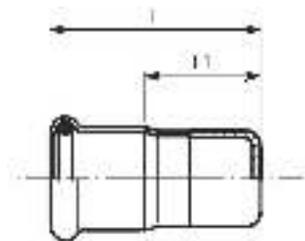

183/003

TAPPO DI CHIUSURA

- STOP END
- VERSCHLUSSKAPPE
- BOUCHON D'OBTURATION
- TAPÓN

MATERIAL: AISI 316L - 1.4404
O-RING: EPDM nero - black - Schwarz - noir - negro

≤54 B 10 11
76÷108 B 10 12
≥139 B 10 17

CODE	De mm	L mm	L1 mm	g	kg	box	€
183015003	15	44	24	32	20	500	-
183018003	18	44	24	38	20	300	-
183022003	22	45	24	51	10	200	-
183028003	28	48	25	68	10	150	-
183035003	35	52	26	95	5	100	-
183042003	42	56	26	126	4	80	-
183054003	54	62	27	185	4	40	-
183076003	76,1	93	38	540	2	10	-
183088003	88,9	99	39	630	2	10	-
183108003	108	117	42	935	2	2	-
183139003	139,7	162	67	1380	1	1	-
183168003	168,3	199	86	2038	1	1	-

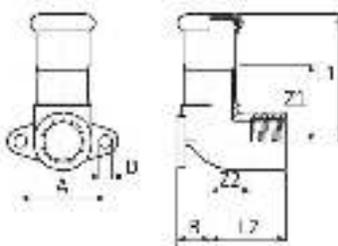

185/000

GOMITO MISTO 90° FF

- WALL PLATE ELBOW 90° FF
- DECKENWINKEL 90° I/I
- EQUERRE 90° FF
- CODO PLACA HH

MATERIAL: AISI 316L - 1.4404
O-RING: EPDM nero - black - Schwarz - noir - negro
THREAD: EN 10226-1 (ex ISO 7/1)

B 10 11

CODE	De x Rp mm x inch	L1 mm	L2 mm	Z1 mm	Z2 mm	A mm	B mm	D mm	g	kg	box	€
185102015	15 x 1/2"	50	30	30	17	34	13	5	98	10	150	-
185102018	18 x 1/2"	51	30	31	17	34	13	5	109	10	150	-
185304022	22 x 3/4"	55	34	34	19	40	17	6	166	10	100	-

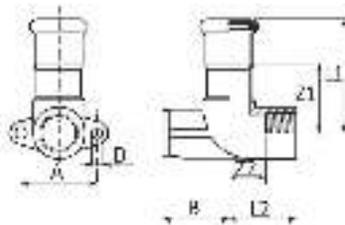

**185/001****B1011****GOMITO MISTO 90° FF CON DISTANZIALE**

- EXTENSION WALL PLATE ELBOW 90° FF
- DECKENWINKEL 90°/W - I/I
- EQUERRE 90° FF AVEC SUPPORT D'AVANCEMENT
- CODO PLACA HH CON ESPACIADOR

MATERIAL: AISI 316L - 1.4404**O-RING:** EPDM nero - black - Schwarz - noir - negro**THREAD:** EN 10226-1 (ex ISO 7/1)

CODE	De x Rp mm x inch	L1 mm	L2 mm	Z1 mm	Z2 mm	A mm	B mm	D mm				€
185102115	15 x 1/2"	50	30	30	17	34	35	5	146	10	150	-
185102118	18 x 1/2"	51	30	31	17	34	35	5	142	10	150	-
185304122	22 x 3/4"	55	34	34	19	40	31	6	182	10	100	-

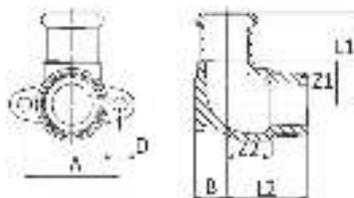
**185/002****B1011****GOMITO MISTO 90° FM**

- WALL PLATE ELBOW 90° FM
- DECKENWINKEL 90° I/A
- EQUERRE 90° FM
- CODO PLACA HM

MATERIAL: AISI 316L - 1.4404**O-RING:** EPDM nero - black - Schwarz - noir - negro**THREAD:** EN 10226-1 (ex ISO 7/1)

CODE	De x R mm x inch	L1 mm	L2 mm	Z1 mm	Z2 mm	A mm	B mm	D mm				€
185304218	18 x 3/4"	38	34	18	19	40	13	6	160	10	100	-

**185/000 M****B1011****GOMITO MISTO 90° MF**

- WALL PLATE ELBOW 90° MF
- DECKENWINKEL 90° A/I
- EQUERRE 90° MF
- CODO PLACA MH

MATERIAL: AISI 316L - 1.4404**THREAD:** EN 10226-1 (ex ISO 7/1)

CODE	De x Rp mm x inch	L1 mm	L2 mm	Z1 mm	Z2 mm	A mm	B mm	D mm				€
185102015M	15 x 1/2"	52	30	21	16,5	34	13	5	100	10	200	-
185102018M	18 x 1/2"	52	30,5	21	17	34	12,5	5	95	10	200	-
185304022M	22 x 3/4"	55	34	24	19	40	17	6	144	10	100	-

B1011

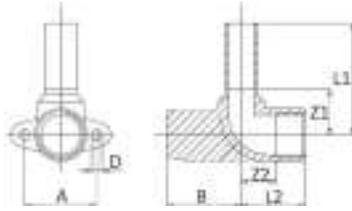

185/001 M

GOMITO MISTO 90° MF CON DISTANZIALE

- EXTENSION WALL PLATE ELBOW 90° MF
- DECKENWINKEL 90°/W A/I
- EQUERRE 90° MF AVEC SUPPORT D'AVANCEMENT
- CODO PLACA MH CON ESPACIADOR

MATERIAL: AISI 316L - 1.4404
THREAD: EN 10226-1 (ex ISO 7/1)

CODE	De x Rp mm x inch	L1 mm	L2 mm	Z1 mm	Z2 mm	A mm	B mm	D mm				€
185102115M	15 x 1/2"	52	30	21	16,5	34	35	5	135	10	150	-
185102118M	18 x 1/2"	52	30	21	16,5	34	35	5	130	10	150	-
185304122M	22 x 3/4"	55	34	24	19	40	31	6	166	10	100	-

B1011

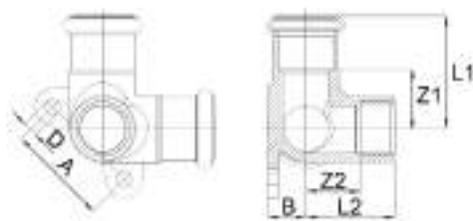

185/003

RACCORDO TRE VIE CON FLANGIA E DERIVAZIONE FILETTO F

- CORNER TEE WITH WALL FLANGE
- INOXPRES-DOPPELWANDSCHEIBE
- EQUERRE MURALE AVEC FILETAGE FEMELLE
- RACOR TRES VÍAS CON BRIDA Y ROSCA HEMBRA

MATERIAL: AISI 316L - 1.4404
O-RING: EPDM nero - black - Schwarz - noir - negro
THREAD: EN 10226-1 (ex ISO 7/1)

CODE	De x Rp x De mm x inch x mm	L1 mm	L2 mm	Z1 mm	Z2 mm	A mm	B mm	D mm				€
185102315	15 x 1/2" x 15	43	32	23	18,5	40	13	6	175	10	100	-
185102318	18 x 1/2" x 18	41	32	21	18,5	40	13	6	165	10	50	-
185102322	22 x 1/2" x 22	44	35	23	21,5	40	15	6	216	5	50	-

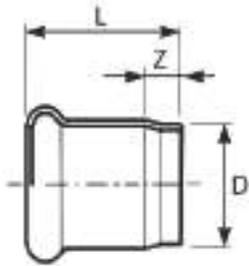
**187/R****MEZZO MANICOTTO A SILDARE**

- HALF WELDING COUPLING
- HALBE LAENGE SCHWEISSMUFFE
- DEMI MANCHON À SOUDER
- MEDIO MANGUITO PARA SOLDAR

MATERIAL: AISI 316L - 1.4404**O-RING:** assente - absent - Abwesend - absent - ausente

≤54 B 10 11

76÷108 B 10 12

≥139 B 10 17

CODE	De mm	D mm	L mm	Z mm				€
187015000R	15	17,2	29	9	20	20	400	-
187018000R	18	20	29,5	9,5	24	20	300	-
187022000R	22	24	30,5	9,5	30	20	200	-
187028000R	28	30	33,5	10,5	40	20	200	-
187035000R	35	37	37,5	11,5	52	10	100	-
187042000R	42	44	41	11	74	10	50	-
187054000R	54	56	48	12	104	10	50	-
187076000R	76,1	76,1	74,5	19,5	308	4	24	-
187088000R	88,9	88,9	84	24	404	2	20	-
187108000R	108	108	100	25	614	1	4	-
187139000R	139,7	139,7	127	32	986	1	1	-
187168000R	168,3	168,3	159	46	1449	1	1	-

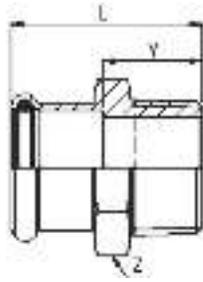

187

≤54 B 10 11
76÷108 B 10 12

MANICOTTO MISTO FILETTO M

- MALE ADAPTER
- ÜBERGANGSSTÜCK MIT AG
- RACCORD AVEC FILETAGE MALE
- UNIÓN MACHO

MATERIAL: AISI 316L - 1.4404
O-RING: EPDM nero - black - Schwarz - noir - negro
THREAD: EN 10226-1 (ex ISO 7/1)

CODE	De x R mm x inch	L mm	Z mm	Y mm				€
187308015	15 x 3/8"	38	24	18	46	20	400	-
187102015	15 x 1/2"	41	24	21	54	20	300	-
187304015	15 x 3/4"	43	30	23	101	20	200	-
187102018	18 x 1/2"	41	27	21	58	20	300	-
187304018	18 x 3/4"	44	30	24	94	20	200	-
187102022	22 x 1/2"	42	32	21	83	10	200	-
187304022	22 x 3/4"	44	32	23	89	10	200	-
187100022	22 x 1"	46	36	25	154	10	100	-
187102028	28 x 1/2"	46	38	23	121	10	100	-
187304028	28 x 3/4"	47	38	24	114	10	100	-
187100028	28 x 1"	48	38	25	123	10	100	-
187114028	28 x 1 1/4"	53	46	30	248	10	100	-
187100035	35 x 1"	52	45	25	173	5	100	-
187114035	35 x 1 1/4"	55	46	28	180	5	50	-
187112035	35 x 1 1/2"	55	50	28	278	4	60	-
187114042	42 x 1 1/4"	59	54	28	240	4	40	-
187112042	42 x 1 1/2"	59	55	28	236	4	40	-
187112054	54 x 1 1/2"	65	65	29	356	4	32	-
187200054	54 x 2"	71	65	35	362	4	32	-
187212076	76,1 x 2 1/2"	98	83	43	769	2	8	-
187300088	88,9 x 3"	111	98	51	1218	2	4	-
187400108	108 x 4"	132	118	57	1842	2	2	-

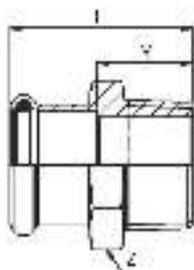

187 NPT

B 10 11

MANICOTTO MISTO FILETTO M NPT

- MALE ADAPTER NPT
- ÜBERGANGSSTÜCK MIT AG NPT
- RACCORD AVEC FILETAGE MALE NPT
- UNIÓN MACHO NPT

MATERIAL: AISI 316L - 1.4404
O-RING: EPDM nero - black - Schwarz - noir - negro
THREAD: NPT - ANSI B 1.20.1

CODE	De x R mm x inch	L mm	Z mm	Y mm				€
18710215NPT	15 x 1/2"	41	24	21	60	20	300	-
18710218NPT	18 x 1/2"	41	27	21	63	20	300	-
18730422NPT	22 x 3/4"	44	32	23	93	10	200	-
18710028NPT	28 x 1"	48	48	25	133	10	100	-
18711435NPT	35 x 1 1/4"	55	46	28	205	5	50	-
18711242NPT	42 x 1 1/2"	59	55	28	268	4	40	-
18720054NPT	54 x 2"	71	65	35	405	4	32	-

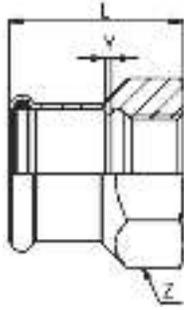

**190****MANICOTTO MISTO FILETTO F**

- FEMALE ADAPTER
- ÜBERGANGSSTÜCK MIT IG
- RACCORD AVEC FILETAGE FEMELLE
- UNIÓN HEMBRA

MATERIAL: AISI 316L - 1.4404**O-RING:** EPDM nero - black - Schwarz - noir - negro**THREAD:** EN 10226-1 (ex ISO 7/1)

CODE	De x Rp mm x inch	L mm	Z mm	Y mm	g			€
190102015	15 x 1/2"	38	27	2	64	20	300	-
190304015	15 x 3/4"	39	32	2	75	20	300	-
190102018	18 x 1/2"	38	27	2	89	20	300	-
190304018	18 x 3/4"	39	32	2	80	10	200	-
190102022	22 x 1/2"	39	32	2	99	20	200	-
190304022	22 x 3/4"	40	32	2	82	10	150	-
190100022	22 x 1"	43	41	2	148	10	100	-
190102028	28 x 1/2"	41	38	2	161	10	100	-
190304028	28 x 3/4"	42	38	2	130	10	100	-
190100028	28 x 1"	45	41	2	158	10	100	-
190114028	28 x 1"1/4	48	46	2	148	10	100	-
190100035	35 x 1"	49	46	2	216	5	100	-
190114035	35 x 1"1/4	52	46	2	170	5	50	-
190112035	35 x 1"1/2	52	55	2	284	4	40	-
190114042	42 x 1"1/4	56	55	2	259	4	40	-
190112042	42 x 1"1/2	56	55	2	243	4	40	-
190112054	54 x 1"1/2	60	65	1	420	4	32	-
190200054	54 x 2"	65	65	2	314	4	20	-

**190 NPT****MANICOTTO MISTO FILETTO F NPT**

- FEMALE ADAPTER NPT
- ÜBERGANGSSTÜCK MIT IG NPT
- RACCORD AVEC FILETAGE FEMELLE NPT
- UNIÓN HEMBRA NPT

MATERIAL: AISI 316L - 1.4404**O-RING:** EPDM nero - black - Schwarz - noir - negro**THREAD:** NPT - ANSI B 1.20.1

CODE	De x Rp mm x inch	L mm	Z mm	Y mm	g			€
19010215NPT	15 x 1/2"	38	27	18	68	20	300	-
19010218NPT	18 x 1/2"	38	27	18	71	20	300	-
19030422NPT	22 x 3/4"	40	32	19	92	10	150	-
19010028NPT	28 x 1"	50	41	27	185	10	100	-
19011435NPT	35 x 1"1/4	49	46	22	181	5	50	-
19011242NPT	42 x 1"1/2	56	55	25	276	4	40	-
19020054NPT	54 x 2"	65	65	29	388	4	20	-

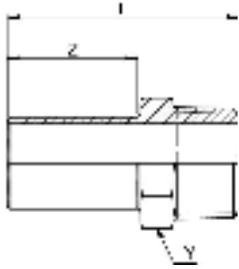

269/M

B1011

MANICOTTO CON INSERIMENTO FILETTO M

- MALE REDUCTION SOCKET
- ÜBERGANG AUSSENGEWINDE MIT EINSCHUBENDE
- MANCHON DE RÉDUCTION FILETÉ
- ADAPTADOR MACHO

MATERIAL: AISI 316L - 1.4404
THREAD: EN 10226-1 (ex ISO 7/1)

CODE	De x R mm x inch	L mm	Z mm	Y mm				€
269102115	15 x 1/2"	52	31	22	55	20	300	-
269102118	18 x 1/2"	52	31	22	50	20	300	-
269304118	18 x 3/4"	55	31	27	95	20	200	-
269102122	22 x 1/2"	55	32	27	69	10	200	-
269304122	22 x 3/4"	56	32	27	80	10	200	-
269304128	28 x 3/4"	61	37	30	97	10	150	-
269100128	28 x 1"	64	37	38	145	10	100	-
269114135	35 x 1 1/4"	72	41	46	238	4	40	-
269112142	42 x 1 1/2"	91	55	55	292	4	40	-
269200154	54 x 2"	127	83	65	463	4	20	-

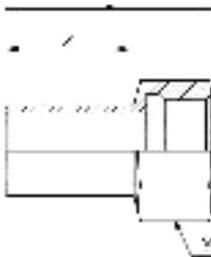

269/F

B1011

MANICOTTO CON INSERIMENTO FILETTO F

- FEMALE REDUCTION SOCKET
- ÜBERGANG INNENGEWINDE MIT EINSCHUBENDE
- MANCHON DE RÉDUCTION AVEC TARAUDAGE
- ADAPTADOR HEMBRA

MATERIAL: AISI 316L - 1.4404
THREAD: EN 10226-1 (ex ISO 7/1)

CODE	De x Rp mm x inch	L mm	Z mm	Y mm				€
269102015	15 x 1/2"	52	31	24	55	20	300	-
269102018	18 x 1/2"	52	31	24	56	20	200	-
269304018	18 x 3/4"	51	31	30	57	20	200	-
269102022	22 x 1/2"	52	32	24	65	10	200	-
269304022	22 x 3/4"	52	32	30	70	10	200	-
269304028	28 x 3/4"	57	37	30	76	10	150	-
269100028	28 x 1"	57	35	36	104	10	100	-
269114035	35 x 1 1/4"	70	45	46	182	5	50	-
269112042	42 x 1 1/2"	118	78	55	280	4	40	-
269200054	54 x 2"	135	83	70	340	2	10	-

B1011

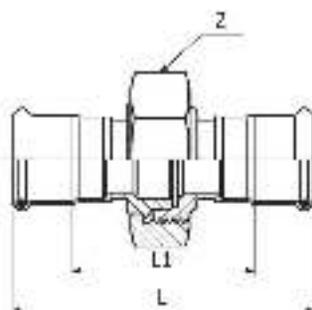

184/000

BOCCHETTONE SEDE CONICA

- CONICAL UNION
- DURCHGANGSVERSCHRAUBUNG MIT PRESSENDEN KONISCH
- ÉLÉMENT DE TRANSITION FILTÉ CONIQUE AVEC MANCHONS DES 2 CÔTES
- RÁCOR 3 PIEZAS CONICO

MATERIAL: AISI 316L – 1.4404

O-RING: EPDM nero - black - Schwarz - noir - negro

CODE	De mm	L mm	L1 mm	Z mm	g			€
184015000	15	96	56	34	146	10	100	-
184018000	18	97	57	39	192	10	100	-
184022000	22	99	57	39	202	10	50	-
184028000	28	116	70	58	468	5	25	-
184035000	35	123	71	67	618	4	20	-
184042000	42	138	78	77	824	2	20	-
184054000	54	154	84	90	1178	2	10	-

B1011

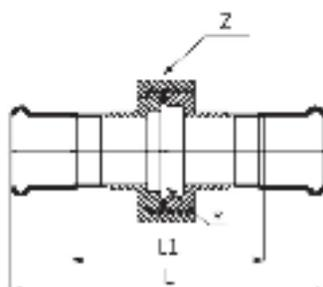

184/001

BOCCHETTONE SEDE PIANA

- FLAT FACED UNION
- DURCHGANGSVERSCHRAUBUNG MIT PRESSENDEN FLACHDICHTEND
- ÉLÉMENT DE TRANSITION FILTÉ PLAT AVEC MANCHONS DES 2 CÔTES
- RÁCOR 3 PIEZAS PLANO

MATERIAL: AISI 316L – 1.4404

O-RING: EPDM nero - black - Schwarz - noir - negro

GASKET: [*]: EPDM nero - black - Schwarz - noir - negro

CODE	De mm	L mm	L1 mm	Z mm	Gasket mm	g		€
184015001	15	96	56	34	24x14 thk 2,5	146	10	120
184018001	18	97	57	39	30x20 thk 2,5	187	10	100
184022001	22	100	58	39	30x20 thk 2,5	194	10	100
184028001	28	117	71	58	47,5x37 thk 2,5	450	5	30
184035001	35	127	75	67	56x42 thk 2,5	617	4	20
184042001	42	140	80	77	66x56 thk 2,5	797	2	20
184054001	54	152	82	90	79,5x69 thk 2,5	1176	2	10

B1011

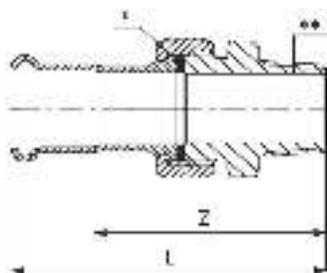

184/002

BOCCHETTONE SEDE PIANA FILETTO M

- STRAIGHT MALE UNION CONNECTOR
- DURCHGANGSVERSCHRAUBUNG MIT AUSSENGEWINDE
- RACCORD UNION FILETÉ
- RÁCOR 3 PIEZAS ROSCADO MACHO

MATERIAL: AISI 316L - 1.4404
FITTING: (**): ottone - brass - Messing - laiton - latón
O-RING: EPDM nero - black - Schwarz - noir - negro
GASKET: (*): EPDM nero - black - Schwarz - noir - negro
THREAD: EN 10226-1 (ex ISO 7/1)

CODE	De x R mm x inch	L mm	Z mm	Gasket mm				€
184015002	15 x 1/2"	76	56	24x14 thk 2,5	142	2	160	-
184018002	18 x 1/2"	77	56	24x14 thk 2,5	144	2	160	-
184022122	22 x 1/2"	79	54	30x20 thk 2,5	199	2	100	-
184022002	22 x 3/4"	81	59	30x20 thk 2,5	202	2	100	-
184028342	28 x 3/4"	87	64	39x27 thk 2,5	370	2	60	-
184028002	28 x 1"	90	67	39x27 thk 2,5	364	2	60	-
184035002	35 x 1 1/4"	101	74	44,5x34 thk 2,5	540	2	40	-
184042002	42 x 1 1/2"	105	74	50,5x40 thk 2,5	563	2	30	-
184054002	54 x 2"	118	83	65,5x53,5 thk 3	823	2	20	-

184/002 - non certificato SVGW - not certified SVGW - ohne Zertifizierung SVGW - sans certification SVGW - sin certificación SVGW

B1011

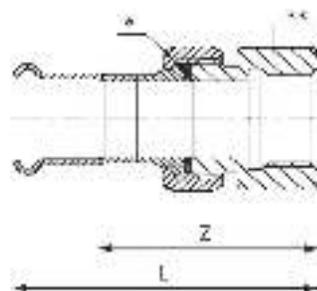

184/003

BOCCHETTONE SEDE PIANA FILETTO F

- STRAIGHT FEMALE UNION CONNECTOR
- DURCHGANGSVERSCHRAUBUNG MIT INNENGEWINDE
- RACCORD UNION TARAUDÉ
- RÁCOR 3 PIEZAS HEMBRA

MATERIAL: AISI 316L - 1.4404
FITTING: (**): ottone - brass - Messing - laiton - latón
O-RING: EPDM nero - black - Schwarz - noir - negro
GASKET: (*): EPDM nero - black - Schwarz - noir - negro
THREAD: EN 10226-1 (ex ISO 7/1)

CODE	De x Rp mm x inch	L mm	Z mm	Gasket mm				€
184015003	15 x 1/2"	71	50	24x14 thk 2,5	140	2	160	-
184018003	18 x 1/2"	72	51	24x14 thk 2,5	145	2	140	-
184022123	22 x 1/2"	75	54	30x20 thk 2,5	253	2	100	-
184022003	22 x 3/4"	76	54	30x20 thk 2,5	213	2	100	-
184028343	28 x 3/4"	83	60	39x27 thk 2,5	483	2	60	-
184028003	28 x 1"	83	60	39x27 thk 2,5	404	2	60	-
184035003	35 x 1 1/4"	93	66	44,5x30 thk 2,5	486	2	30	-
184042003	42 x 1 1/2"	97	66	56x42 thk 2,5	536	2	30	-
184054003	54 x 2"	116	81	65,5x53,5 thk 2,5	1091	2	20	-

184/003 - non certificato SVGW - not certified SVGW - ohne Zertifizierung SVGW - sans certification SVGW - sin certificación SVGW



B1011

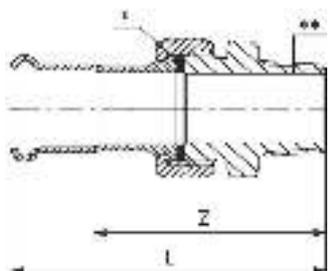

184/002 INOX

BOCCHETTONE SEDE PIANA FILETTO M

- STRAIGHT MALE UNION CONNECTOR
- DURCHGANGSVERSCHRAUBUNG MIT AUSSENGEWINDE
- RACCORD UNION FILETÉ
- RÁCOR 3 PIEZAS ROSCADO MACHO

MATERIAL: AISI 316L - 1.4404

FITTING: (**): AISI 316L - 1.4404

O-RING: EPDM nero - black - Schwarz - noir - negro

GASKET: (*): EPDM nero - black - Schwarz - noir - negro

THREAD: EN 10226-1 (ex ISO 7/1)

CODE	De x R mm x inch	L mm	Z mm	Gasket mm	g			€
184015002I	15 x 1/2"	77	56	24x14 thk 2,5	137	2	160	-
184015012I	15 x 3/4"	77	57	24x14 thk 2,5	178	2	160	-
184018002I	18 x 1/2"	77	56	24x14 thk 2,5	139	2	160	-
184018012I	18 x 3/4"	77	57	24x14 thk 2,5	178	2	160	-
184022012I	22 x 1/2"	79	58	30x20 thk 2,5	217	2	100	-
184022002I	22 x 3/4"	81	59	30x20 thk 2,5	194	2	100	-
184022022I	22 x 1"	81	60	30x20 thk 2,5	257	2	80	-
184028002I	28 x 1"	90	67	39x27 thk 2,5	350	2	60	-
184035002I	35 x 1 1/4"	101	74	44,5x34 thk 2,5	518	2	40	-
184042002I	42 x 1 1/2"	102	71,5	44,5x34 thk 2,5	543	2	30	-
184054002I	54 x 2"	111	77	56x42 thk 2,5	842	2	20	-

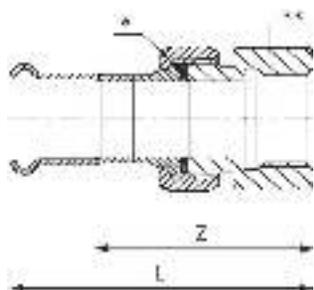

184/003 INOX

B1011

BOCCHETTONE SEDE PIANA FILETTO F

- STRAIGHT FEMALE UNION CONNECTOR
- DURCHGANGSVERSCHRAUBUNG MIT INNENGEWINDE
- RACCORD UNION TARAUDÉ
- RÁCOR 3 PIEZAS HEMBRA

MATERIAL: AISI 316L - 1.4404

FITTING: (**): AISI 316L - 1.4404

O-RING: EPDM nero - black - Schwarz - noir - negro

GASKET: (*): EPDM nero - black - Schwarz - noir - negro

THREAD: EN 10226-1 (ex ISO 7/1)

CODE	De x Rp mm x inch	L mm	Z mm	Gasket mm	g			€
184015003I	15 x 1/2"	71	50	24x14 thk 2,5	135	2	160	-
184015013I	15 x 3/4"	74	54	24x14 thk 2,5	189	2	120	-
184018003I	18 x 1/2"	72	51	24x14 thk 2,5	140	2	140	-
184018013I	18 x 3/4"	75	55	24x14 thk 2,5	190	2	120	-
184022003I	22 x 3/4"	76	54	30x20 thk 2,5	206	2	100	-
184022013I	22 x 1"	79	58	30x20 thk 2,5	337	2	60	-
184028003I	28 x 1"	83	60	39x27 thk 2,5	387	2	60	-
184035003I	35 x 1 1/4"	93	66	44,5x34 thk 2,5	467	2	30	-
184042003I	42 x 1 1/2"	93	62,5	44,5x34 thk 2,5	488	2	30	-
184054003I	54 x 2"	111	77	56x42 thk 2,5	902	2	20	-

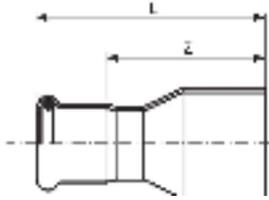

191

RIDUZIONE MF

- REDUCER
- REDUZIERSTÜCK
- REDUCTION
- REDUCCIÓN MH

MATERIAL: AISI 316L - 1.4404

O-RING: EPDM nero - black - Schwarz - noir - negro

≤54 B 10 11
76÷108 B 10 12
≥139 B 10 17

CODE	De mm	L mm	Z mm				€
191018015	18 x 15	57	37	35	20	500	-
191022015	22 x 15	64	44	43	20	400	-
191022018	22 x 18	60	40	47	20	300	-
191028015	28 x 15	76,5	56,5	50	20	200	-
191028018	28 x 18	68	48	63	20	200	-
191028022	28 x 22	65	44	66	20	200	-
191035015	35 x 15	87	67	89	10	100	-
191035018	35 x 18	81	61	87	10	100	-
191035022	35 x 22	70	49	90	10	100	-
191035028	35 x 28	71	48	98	10	100	-
191042015	42 x 15	91	71	111	4	100	-
191042018	42 x 18	92	72	114	4	80	-
191042022	42 x 22	97	76	120	4	80	-
191042028	42 x 28	93	70	130	4	80	-
191042035	42 x 35	81	55	138	4	40	-
191054015	54 x 15	103	83	158	4	40	-
191054018	54 x 18	103	83	162	4	40	-
191054022	54 x 22	104	83	169	4	40	-
191054028	54 x 28	108,5	85,5	180	4	40	-
191054035	54 x 35	108	82	193	4	40	-
191054042	54 x 42	97,5	67,5	210	4	32	-
191076042	76,1 x 42	149	119	471	4	4	-
191076054	76,1 x 54	159	124	529	4	4	-
191088054	88,9 x 54	179	144	683	4	4	-
191088076	88,9 x 76,1	186	131	813	4	4	-
191108054	108 x 54	185	150	831	2	2	-
191108076	108 x 76,1	209	154	1022	2	2	-
191108088	108 x 88,9	210	150	1107	2	2	-
191139076	139,7 x 76,1	356,5	301,5	2100	1	1	-
191139088	139,7 x 88,9	380	320	2319	1	1	-
191139108	139,7 x 108	345	270	2285	1	1	-
191168076	168,3 x 76,1	369	315	2515	1	1	-
191168088	168,3 x 88,9	380	320	2660	1	1	-
191168108	168,3 x 108	395	320	2945	1	1	-
191168139	168,3 x 139,7	422	327	3392	1	1	-

B1011

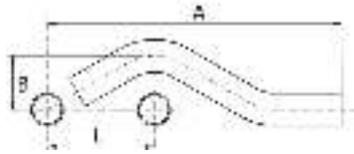

179

"S" DI SCAVALCAMENTO MM

- PIPE BRIDGE
- SPRUNGBOGEN
- "S" DE CHEVAUCHEMENT MALE
- "S" DE SUPERPOSICIÓN MM

MATERIAL: AISI 316L - 1.4404

CODE	De mm	L mm	A mm	B mm	g			€
179015000	15	57	158	30	54	10	150	-
179018000	18	60	166	31	74	10	100	-
179022000	22	65	179	33	116	10	100	-
179028000	28	73	206	36	192	10	50	-

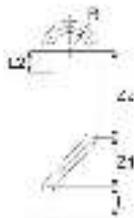

178

TUBO PER ARIA COMPRESSA

- PIPE FOR COMPRESSED AIR
- SPRUNGBOGEN FÜR DRUCKLUFT
- TUBE POUR L'AIR COMPRIMÉ
- TUBO DE AIRE

MATERIAL: AISI 316L - 1.4404

CODE	De mm	L1 mm	L2 mm	Z1 mm	Z2 mm	R mm	g		€	
178015316	15	30	30	96	114	35	143	1	20	-
178018316	18	50	35	108	112	39	195	1	20	-
178022316	22	50	35	110	110	41	359	1	20	-
178028316	28	60	40	139	113	51	550	1	15	-

B1011

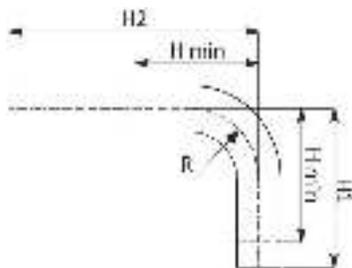

194/900

TUBO CURVO 90°

- 90° ELBOW MM
- PASSBOGEN 90°
- COUDE D'AJUSTEMENT 90°
- TUBO RICURVO 90° MM

MATERIAL: AISI 316L - 1.4404

CODE	De mm	H1 mm	H min mm	H2 mm	R mm	g		€	
194015900	15	70	48	120	35	89	20	160	-
194018900	18	70	53	120	38	108	20	120	-
194022900	22	70	61	120	40	133	10	100	-
194028900	28	97	80	125	45	202	10	50	-
194035900	35	120	90	200	42	380	4	20	-
194042900	42	160	115	250	50	592	2	10	-
194054900	54	300	140	305	65	1139	2	2	-

B1011

B1011

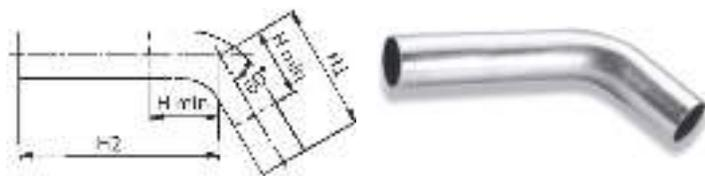

194/600

TUBO CURVO 60°

- 60° ELBOW MM
- PASSBOGEN 60°
- COUDE D'AJUSTEMENT 60°
- TUBO RICURVO 60° MM

MATERIAL: AISI 316L - 1.4404

CODE	De mm	H1 mm	H min mm	H2 mm	g	kg	box	€
194028600	28	71	64	116	182	10	50	-
194035600	35	101	71	226	406	4	24	-
194042600	42	124	80	251	563	2	10	-
194054600	54	162	97	308	914	2	2	-

≤54 B1011

76÷108 B1012

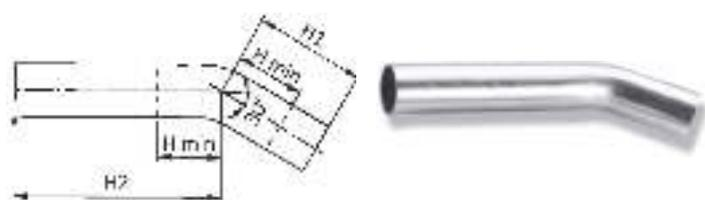

194/300

TUBO CURVO 30°

- 30° ELBOW MM
- PASSBOGEN 30°
- COUDE D'AJUSTEMENT 30°
- TUBO RICURVO 30° MM

MATERIAL: AISI 316L - 1.4404

CODE	De mm	H1 mm	H min mm	H2 mm	g	kg	box	€
194018300	18	55	39	128	113	20	120	-
194022300	22	50	44	124	134	10	50	-
194028300	28	55	47	131	183	10	50	-
194035300	35	80	50	218	375	4	24	-
194042300	42	98	54	274	566	2	10	-
194054300	54	137	72	324	909	2	2	-
194076300	76,1	201	135	201	1489	1	1	-
194088300	88,9	241	161	241	2095	1	1	-
194108300	108	263	168	263	2787	1	1	-

≤54 B1011

76÷108 B1012

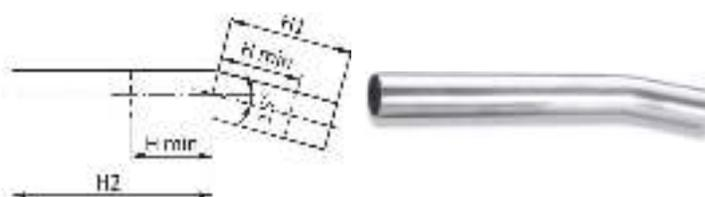

194/150

TUBO CURVO 15°

- 15° ELBOW MM
- PASSBOGEN 15°
- COUDE D'AJUSTEMENT 15°
- TUBO RICURVO 15° MM

MATERIAL: AISI 316L - 1.4404

CODE	De mm	H1 mm	H min mm	H2 mm	g	kg	box	€
194018150	18	55	40	128	114	20	120	-
194028150	28	45	38	136	180	10	50	-
194035150	35	62	32	234	373	4	24	-
194042150	42	94	50	276	563	2	10	-
194054150	54	117	52	337	896	2	2	-
194076150	76,1	228	163	228	1694	1	1	-
194088150	88,9	240	160	240	2091	1	1	-
194108150	108	249	154	249	2646	1	1	-

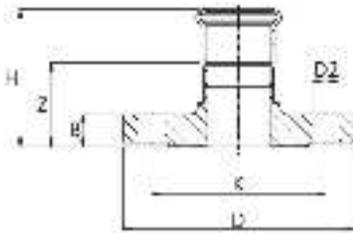
**193/002**

≤54 B 10 11

76÷108 B 10 12

**MANICOTTO
FLANGIATO**

- ADAPTOR FLANGE
- ÜBERGANGSFLANSCH
- BRIDE DE RACCORDEMENT
- BRIDA ADAPTADOR

MATERIAL: AISI 316L - 1.4404**O-RING:** EPDM nero - black - Schwarz - noir - negro**PN 6**

CODE	De mm	DN flg	H mm	Z mm	B mm	D mm	D2 mm	Holes Nr.	K mm				€
193015002	15	15	53	33	12	80	11	4	55	405	2	20	-
193018002	18	15	53,5	33,5	12	80	11	4	55	405	2	20	-
193022002	22	20	56,5	35,5	14	90	11	4	65	610	2	14	-
193028002	28	25	59,5	36,5	14	100	11	4	75	755	2	10	-
193035002	35	32	63	37	14	120	14	4	90	1080	2	6	-
193042002	42	40	67	37	14	130	14	4	100	1186	2	6	-
193054002	54	50	74	38	14	140	14	4	110	1348	2	4	-
193076002	76,1	65	101	45,5	14	160	14	4	130	1870	2	2	-
193088002	88,9	80	112	52	16	190	18	4	150	2920	2	2	-
193108002	108	100	128	53	16	210	18	4	170	3525	2	2	-

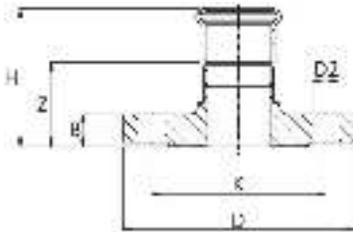
**193/000**

≤54 B 10 11

76÷108 B 10 12

≥139 B 10 17

**MANICOTTO
FLANGIATO**

- ADAPTOR FLANGE
- ÜBERGANGSFLANSCH
- BRIDE DE RACCORDEMENT
- BRIDA ADAPTADOR

MATERIAL: AISI 316L - 1.4404**O-RING:** EPDM nero - black - Schwarz - noir - negro**PN 16**

CODE	De mm	DN flg	H mm	Z mm	B mm	D mm	D2 mm	Holes Nr.	K mm				€
193015000	15	15	55	35	14	95	14	4	65	660	2	20	-
193018000	18	15	55,5	35,5	14	95	14	4	65	660	2	20	-
193022000	22	20	58,5	37,5	16	105	14	4	75	945	2	14	-
193028000	28	25	61,5	38,5	16	115	14	4	85	1140	2	10	-
193035000	35	32	65,5	39,5	16	140	18	4	100	1640	2	6	-
193042000	42	40	69	39	16	150	18	4	110	1800	2	6	-
193054000	54	50	78	42	18	165	18	4	125	2450	2	4	-
193076000	76,1	65	105	50	18	185	18	4	145	3184	2	2	-
193088000	88,9	80	116	56	20	200	18	8	160	3950	2	2	-
193108000	108	100	132	57	20	220	18	8	180	4729	2	2	-
193139000	139,7	125	180	85	22	250	18	8	210	7095	1	1	-
193168000	168,3	150	212	91,5	22	285	22	8	240	8929	1	1	-

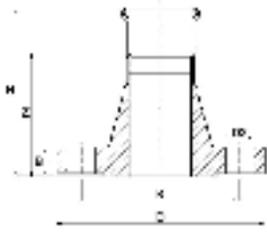

193/006

≤54 B 10 11
 76÷108 B 10 12

MANICOTTO FLANGIATO

- ADAPTOR FLANGE
- ÜBERGANGSFLANSCH
- BRIDE DE RACCORDEMENT
- BRIDA ADAPTADOR

ANSI 150 lb

MATERIAL: AISI 316L - 1.4404
O-RING: EPDM nero - black - Schwarz - noir - negro

CODE	De mm	DN flg	H mm	Z mm	B mm	D mm	D2 mm	Holes Nr.	K mm				€
193015006	15	15	79,7	59,7	14,1	89	15,8	4	60,3	641	2	18	-
193018006	18	15	77,1	57,1	11,2	89	15,8	4	60,3	501	2	18	-
193022006	22	20	82,9	61,9	12,8	98,5	15,8	4	69,8	749	2	12	-
193028006	28	25	89,1	66,1	14,3	108	15,8	4	79,3	1062	2	8	-
193035006	35	32	94,4	68,4	15,9	117,5	15,8	4	88,9	1420	2	6	-
193042006	42	40	102,9	72,9	17,5	127,1	15,8	4	98,4	1809	2	4	-
193054006	54	50	111,1	75,5	19,1	152,5	19	4	120,6	2714	2	2	-
193076006	76,1	65	122,5	67,5	22,3	177,9	19	4	139,7	4194	2	2	-
193088006	88,9	80	150,9	90,9	23,8	190,6	19	4	152,4	5338	2	2	-
193108006	108	100	172,2	97,2	23,8	228,7	19	8	190,5	7525	2	2	-

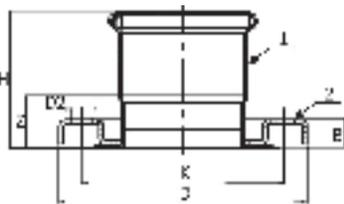

193/001

≤54 B 10 11
 76÷108 B 10 12
 ≥139 B 10 17

MANICOTTO CON FLANGIA SCORREVOLE

- ADAPTOR LOOSE FLANGE
- ÜBERGANGSLOSFLANSCH
- BRIDE TOURNANTE DE RACCORDEMENT
- BRIDA LOCA CON ADAPTADOR

PN 10

MATERIAL: 1 - AISI 316L - 1.4404
 2 - AISI 304 - 1.4301
O-RING: EPDM nero - black - Schwarz - noir - negro

CODE	De mm	DN flg	H mm	Z mm	B mm	D mm	D2 mm	Holes Nr.	K mm				€
193054001	54	50	60	24	21	165	18	4	125	895	2	6	-
193076001	76,1	65	86,5	31,5	23,5	185	18	4	145	1380	2	2	-
193088001	88,9	80	96	36	23,5	200	18	8	160	1380	2	2	-
193108001	108	100	116	41	24	220	18	8	180	1950	2	2	-
193139001	139,7	125	143	48	25,5	250	18	8	210	3352	1	1	-
193168001	168,3	150	176	63	28	285	22	8	240	4419	1	1	-

**193/004**

≤54 B 10 11
76÷108 B 10 12

BOCCELLO PER FLANGIA LIBERA

- COLLAR FOR LOOSE FLANGE
- AUSSEN FÜR LOSE-FLANSCH
- SORTIE A BRIDE POUR BRIDE TOURNANTE
- TRONCO EMBRIDADO PARA BRIDA LOCA

MATERIAL: AISI 316L - 1.4404

PN 6

CODE	De mm	L mm	H mm	D mm	D1 mm	D2 mm				€
193022004	22	135	6	50	27	22	210	2	14	-
193028004	28	135	6	60	32	28	260	2	14	-
193035004	35	135	6	70	40	35	350	2	14	-
193042004	42	135	6	80	46	42	420	2	14	-
193054004	54	135	8	90	59	54	580	2	14	-
193076004	76,1	135	8	110	78	76,1	840	2	12	-
193088004	88,9	135	10	128	91	88,9	1150	2	6	-
193108004	108	135	10	148	110	108	1390	2	2	-

**193/003**

≤54 B 10 11
76÷108 B 10 12

BOCCELLO PER FLANGIA LIBERA

- COLLAR FOR LOOSE FLANGE
- AUSSEN FÜR LOSE-FLANSCH
- SORTIE A BRIDE POUR BRIDE TOURNANTE
- TRONCO EMBRIDADO PARA BRIDA LOCA

MATERIAL: AISI 316L - 1.4404

PN 16

CODE	De mm	L mm	H mm	D mm	D1 mm	D2 mm				€
193022003	22	135	6	58	27	22	240	2	14	-
193028003	28	135	6	68	32	28	300	2	14	-
193035003	35	135	6	78	40	35	390	2	14	-
193042003	42	135	6	88	46	42	470	2	14	-
193054003	54	135	8	102	59	54	700	2	14	-
193076003	76,1	135	8	122	78	76,1	980	2	4	-
193088003	88,9	135	10	138	91	88,9	1310	2	4	-
193108003	108	135	10	158	110	108	1580	2	2	-

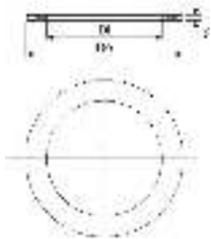
434/PN 6
R 30 30
GUARNIZIONE ECOLOGICA PER FLANGE

- GASKET FOR FLANGE
- FLANSCHDICHTUNG
- JOINT POUR BRIDE
- JUNTA ECOLÓGICA PARA BRIDA

PN 6
MATERIAL: Sesalit Eco
NORM: EN 1092-1

CODE	DN	De mm	Di mm	S mm			€
434015006	15 - [1/2"]	44	20	2	4	10	-
434020006	20 - [3/4"]	54	25	2	6	10	-
434025006	25 - [1"]	64	30	2	9	10	-
434032006	32 - [1 1/4"]	75	38	2	11	10	-
434040006	40 - [1 1/2"]	85	45	2	14	10	-
434050006	50 - [2"]	95	57	2	15	10	-
434065006	65 - [2 1/2"]	115	76	2	19	10	-
434080006	80 - [3"]	132	89	2	26	10	-
434100006	100 - [4"]	152	108	2	29	10	-

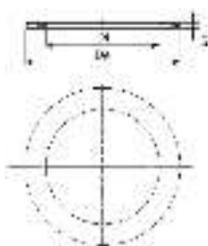
434/PN 10-16
R 30 30
GUARNIZIONE ECOLOGICA PER FLANGE

- GASKET FOR FLANGE
- FLANSCHDICHTUNG
- JOINT POUR BRIDE
- JUNTA ECOLÓGICA PARA BRIDA

PN 10/16
MATERIAL: Sesalit Eco
NORM: EN 1092-1

CODE	DN	De mm	Di mm	S mm			€
434015000	15 - [1/2"]	50	20	2	6	10	-
434020000	20 - [3/4"]	60	25	2	8	10	-
434025000	25 - [1"]	70	30	2	10	10	-
434032000	32 - [1 1/4"]	82	38	2	14	10	-
434040000	40 - [1 1/2"]	92	45	2	17	10	-
434050000	50 - [2"]	108	57	2	22	10	-
434065000	65 - [2 1/2"]	127	76	2	27	10	-
434080000	80 - [3"]	142	89	2	30	10	-
434100000	100 - [4"]	162	108	2	38	10	-

Sesalit ECO: fibre organiche e sintetiche legate con gomma NBR/SBR esente amianto
 IMPIEGHI: Acqua calda e fredda, olii vegetali ed animali, aria, alcuni carburanti (no GAS)

LIMITI DI TEMPERATURA ORIENTATIVI

Temperatura massima per brevi esposizioni: 180°-200° C
 Temperatura massima di esercizio continuo per fluidi non aggressivi: 140° C
 Temperatura massima di esercizio continuo con vapore: 110° C

OMOLOGAZIONI: acqua potabile WRAS n° 1605525

Sesalit ECO: organic and synthetic fibers bonded with NBR/SBR asbestos-free

USES: hot and cold water, vegetable and animal oils, air, some fuels (no GAS)

GUIDELINE TEMPERATURE LIMITS

Maximum temperature for short exposure: 180°-200° C
 Maximum operating temperature for continuous non-aggressive fluids: 140° C
 Maximum temperature for continuous operation with steam: 110° C

APPROVAL: potable water WRAS n° 1605525

**179/001**

≤54 B 10 11

76÷108 B 10 12

PASSAGGIO STAGNO

- DECK / BULKHEAD PENETRATION
- WANDDURCHFÜHRUNG
- PASSAGE ÉTANCHE
- PASAJE ESTAÑO

MATERIAL: AISI 316L - 1.4404**NOTE:** (*): S235JR (Fe 360)

CODE	De mm	L mm	L1 mm	Z mm	D mm	D1 mm				€
179015001	15	450	120	165	25	15	460	1	65	-
179018001	18	450	120	165	30	18	621	1	65	-
179022001	22	450	120	165	33	22	701	1	50	-
179028001	28	450	120	165	37	28	776	1	45	-
179035001	35	450	120	165	43,5	35	936	1	40	-
179042001	42	450	120	165	53	42	1291	1	30	-
179054001	54	450	120	165	69	54	1965	1	18	-
179076001	76,1	450	120	165	88,5	76,1	2840	1	8	-
179088001	88,9	450	120	165	107	88,9	4081	1	8	-
179108001	108	450	120	165	131,5	108	5682	1	6	-

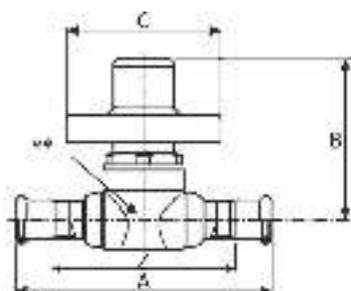
**195/000**

B 10 11

RUBINETTO DA INCASSO CON ROSONE

- STOPVALVE WITH PRESS ENDS
- UP-VENTIL MIT PRESSENDEN
- ROBINET ENCASTRE AVEC ROSACE
- VÁLVULA DE BOLA "PRES" CON EMBECELLADOR

MATERIAL: AISI 316L - 1.4404**O-RING:** EPDM nero - black - Schwarz - noir - negro**NOTE:** (**): Movimento interno in Ottone - Kugel aus Messing - Ball out of brass - Mouvement en laiton - Bola en latón

CODE	De mm	Z mm	A mm	B mm	C mm				€
195015000	15	42	101	74	70	330	1	10	-

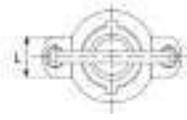
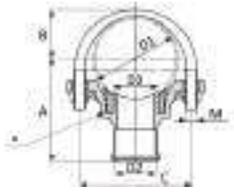

171/P

COLLARE DI PRESA CON DERIVAZIONE A PRESSARE

- BRACKET WITH FEMALE PRESS CONNECTION
- ANBOHRSCHELLE MIT PRESSENDEN
- COLLIER DE PRISE AVEC DÉRIVATION F
- CONJUNTO DERIVACIÓN DE PRENSAR

MATERIAL: AISI 316L - 1.4404

O-RING: EPDM nero - black - Schwarz - noir - negro

GASKET: [*]: EPDM guarnizione - gasket - Dichtung - joint - juntas

CODE	D1 mm	D2 mm	D3 mm	A mm	B mm	C mm	L mm	M mm	g	kg	Box	€
171076035	76,1	35	42	90	44	100	35	M 10 x 35	700	1	20	-
171088042	88,9	42	50	97	53	115	40	M 10 x 35	740	1	10	-
171108054	108	54	60	116	60	135	45	M 10 x 35	1090	1	10	-

Montaggio - Assembly - Montage - Assemblage - Montaje



Fig. 1



Fig. 2



Fig. 3



Fig. 4



Fig. 5



Fig. 6



Fig. 7



Fig. 8



Fig. 9



Fig. 10



Fig. 11



Fig. 12

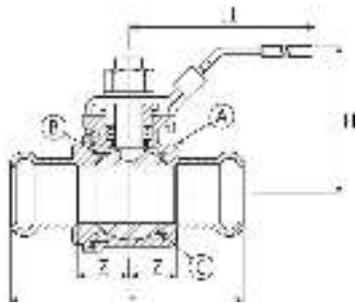

195/005

B 10 11

VALVOLA A SFERA PASSAGGIO TOTALE

- BALL VALVE WITH FULL PORT
- KUGELHAHN MIT VOLLEM DURCHGANG
- BOISSEAU SPHERIQUE PASSAGE RÉDUIT
- VÁLVULA DE BOLA PASO TOTAL

MATERIAL: A-C: AISI 316L - 1.4404 B: PTFE

O-RING: EPDM nero - black - Schwarz - noir - negro

CODE	De mm	L mm	L1 mm	H mm	Z mm				€
195015005	15	85	97,5	50	20	275	1	10	-
195018005	18	88	123	59	20	430	1	10	-
195022005	22	100	123	62,5	21	508	1	10	-
195028005	28	107	145	69,5	23	786	1	10	-

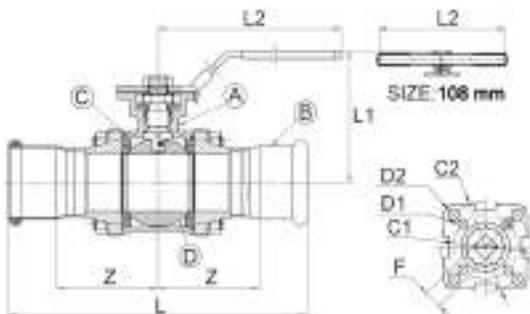

195/003

≤54 B 10 11

76÷108 B 10 12

VALVOLA A SFERA 3 PZ PASSAGGIO TOTALE LUCCHETTABILE CON BASE PER ATTUATORE

- 3-PC BALL VALVE WITH FULL PORT
- KUGELHAHN 3-TEILIG MIT VOLLEM DURCHGANG
- BOISSEAU SPHERIQUE 3 PIÈCES PASSAGE INTÉGRAL
- VÁLVULA DE BOLA TRES PIEZAS PASO TOTAL

MATERIAL: A-B-D: AISI 316L - 1.4404 C: PTFE

O-RING: EPDM nero - black - Schwarz - noir - negro

NORM: flangia / flange / Flansch
bride / brida ISO 5211

CODE	De mm	DN	DN inch	L mm	Z mm	L1 mm	L2 mm	C1 mm	C2 mm	D1 mm	D2 mm	F mm				€
195015003	15	10	3/8"	128	44	72	151	36	42	6	6	9	698	1	10	-
195018003	18	15	1/2"	134	47	72	151	36	42	6	6	9	714	1	10	-
195022003	22	20	3/4"	151	54,5	80	151	36	50	6	7	9	992	1	10	-
195028003	28	25	1"	167	60,5	90	179	42	50	6	7	11	1476	1	5	-
195035003	35	32	1 1/4"	184	66	95	179	42	70	6	9	11	2280	1	5	-
195042003	42	40	1 1/2"	207	73,5	104	198	50	70	7	9	14	3122	1	5	-
195054003	54	50	2"	245	87,5	110	198	50	70	7	9	14	4600	1	2	-
195076003	76,1	65	2 1/2"	334	112	150	270	70	102	9	11	17	9500	1	2	-
195088003	88,9	80	3"	384	132	159	270	70	102	9	11	17	13800	1	1	-
195108003*	108	100	4"	470	160	210	405	-	102	-	11	22	25000	1	1	-

(* DN 108 con tubo maniglia, with pipe handle, mit Rohrgriff, avec tube-poignée, con mango de tubo

Le condizioni stampigliate sono relative al corpo della valvola. La pressione massima di lavoro delle valvole art. 195/003 = 16 bar. Con flangia per attuatore. The marked pressure's conditions are related to the body of the valve. Maximum working pressure for pressfitting valve art. 195/003 = 16 bar. With flange for actuator.

Die markierte Konditionen der Pressfitting entsprechend den Kugelhahnkoerper. Maximaler Arbeitsbetriebsdruck für Kugelhahn 195/003 = 16 bar. Mit Flansch für Stellantrieb.

Les conditions de pressions indiquées sur la presse vannes correspondent au corps de vanne. Pression de service maximale des vannes 195/003 = 16 bar. Avec bride pour actuateur.

Condiciones de presión marcadas están relacionadas con el cuerpo de la válvula. La presión máxima de trabajo de las válvulas art. 195/003 = 16 bar. Con brida para actuador.

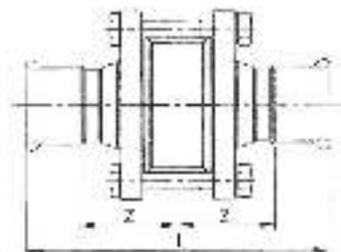

195/004

≤54 B 10 11
 76÷108 B 10 12

VALVOLA DI RITEGNO

- NON-RETURN VALVE
- RÜCKSCHLAGVENTIL
- CLAPET ANTI-RETOUR
- VÁLVULA DE RETENCIÓN

MATERIAL: AISI 316L - 1.4404

O-RING: EPDM nero - black - Schwarz - noir - negro

CODE	De mm	DN	L mm	Z mm				€
195015004	15	15	114	37	412	1	10	-
195018004	18	15	114	37	422	1	10	-
195022004	22	20	121	39,5	570	1	10	-
195028004	28	25	138	46	767	1	10	-
195035004	35	32	158	53	1238	1	10	-
195042004	42	40	180	60	1766	1	6	-
195054004	54	50	200	64,5	2418	1	2	-
195076004	76,1	65	271	80,5	5208	1	1	-
195088004	88,9	80	302	91	7108	1	1	-
195108004	108	100	370	110	12366	1	1	-

Le condizioni stampigliate sono relative al corpo della valvola. La pressione massima di lavoro delle valvole art. 195/004 = 16 bar
 The marked pressure's conditions are related to the body of the valve. Maximum working pressure for pressfitting valve art. 195/004 = 16 bar
 Die markierte Konditionen der Pressfitting entsprechend den Kugelhahnkoerper. Maximaler Arbeitsbetriebsdruck für Kugelhahn 195/004 = 16 bar
 Les conditions de pressions indiquées sur la presse vannes correspondent au corps de vanne. Pression de service maximale des vannes 195/004 = 16 bar.
 Condiciones de presión marcadas están relacionadas con el cuerpo de la válvula. La presión máxima de trabajo de las válvulas art. 195/004 = 16 bar

**DIAGRAMMA PERDITA DI CARICO
 PRESSURE LOSS DIAGRAM**

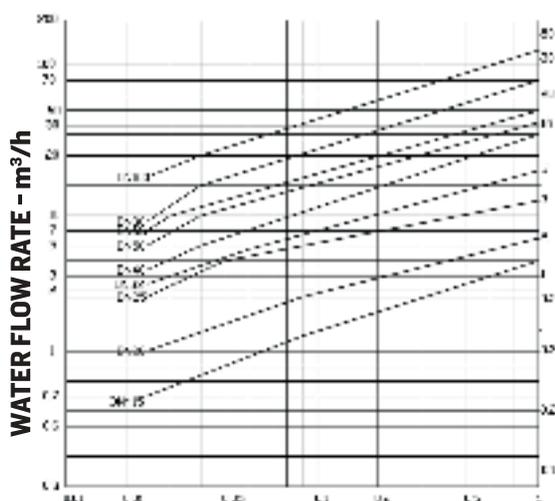

DN15-DN100 PRESSURE LOSS - bar

CV / KV PER VALVOLA DI RITEGNO CV / KV FOR NON-RETURN VALVE				DIREZIONE DI FLUSSO FLOW DIRECTION		
DE	DN DN inch	CV US gallon/min	KV m³/h	↑	↓	→
				Pressione di apertura Opening pressure (mbar)		
15	15 - 1/2"	4,1	3,5	25	21	23
18	15 - 1/2"	4,1	3,5	25	21	23
22	20 - 3/4"	5,1	4,4	25	21	23
28	25 - 1"	14	12	25	21	23
35	32 - 1 1/4"	23,3	20	27	21	24
42	40 - 1 1/2"	30,3	26	29	21	25
54	50 - 2"	37,3	32	29	21	25
76,1	65 - 2 1/2"	70	60	31	21	25
88,9	80 - 3"	81,7	70	32	21	26
108	100 - 4"	140	120	33	21	27

NOTE

Cv = flusso di acqua (a 60°F) in gpm (galloni al minuto) con una pressione differenziale (caduta di pressione) di 1 psi.
 Kv = flusso di acqua (tra 5° e 40°) m³/h, con una pressione differenziale (caduta di pressione) di 1 bar.
 [1 Kv = 0,86 Cv]



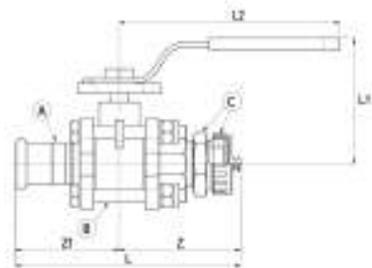

195/008

VALVOLA A SFERA CON PRESA
MANICHETTA

- BALL VALVE WITH HOSE CONNECTION
- KUGELHAHN MIT SCHLAUCHANSCHLUSS
- BOISSEAU SPHERIQUE AVEC RACCORD DETUYAU
- VÁLVULA DE BOLA CON CONEXIÓN DELA MANGUERA

MATERIAL: A-B: AISI 316L – 1.4404
C: ottone - brass - Messing - laiton - latón

O-RING: EPDM nero - black - Schwarz - noir - negro

CODE	De mm	L mm	L1 mm	L2 mm	Z mm	Z1 mm				€
195015008	15 x 3/4"	131,5	72	151	67,5	64	873	1	10	-
195022008	22 x 1"	148,5	80	151	73	75,5	1314	1	10	-

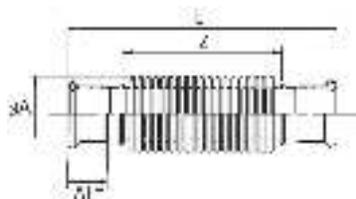

199

COMPENSATORE DI
DILATAZIONE

- EXPANSION COMPENSATOR
- WELLENKOMPENSATOR
- COMPENSATEUR D'EXPANSION
- DILATADOR

MATERIAL: AISI 316L – 1.4404

O-RING: EPDM nero - black - Schwarz - noir - negro

≤54 B 10 11

76÷108 B 10 12

CODE	De mm	L mm	ΔL* mm	Cycles**	Z mm	A mm				€
199015000	15	139	16	800	71	22	80	1	100	-
199018000	18	143	18	800	74	27	108	1	80	-
199022000	22	139	20	800	68	34	130	1	80	-
199028000	28	150	22	800	73	41	155	1	40	-
199035000	35	177	26	800	90	51	251	1	24	-
199042000	42	202	32	800	107	61	440	1	16	-
199054000	54	221	36	800	113	71	550	1	12	-
199076000	76,1	278	30	500	180	87	1464	1	1	-
199088000	88,9	314	40	500	235	105	1871	1	1	-
199108000	108	388	50	500	255	131	2845	1	1	-

[*] Corsa assiale in compressione - Compression axial stroke - Axialhub in Kompression - Course axiale en compression - Carrera axial en compresión

[**] Numero di cicli di lavoro alla massima compressione - Work cycles number at maximum compression - Anzahl der Zyklen bei einer maximaler Kompression - Nombre de cycles de travail à compression maximale - Número de ciclos de trabajo a máxima compresión

B1011

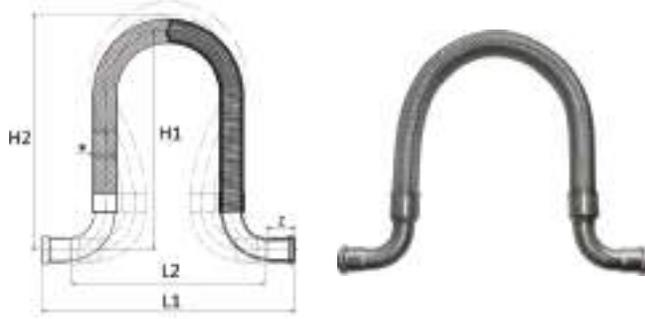

199/001

TUBO FLESSIBILE AD OMEGA

- U-BEND FLEXIBLE PIPE
- FLEXIBLES ECKSTÜCK ZUM EINPRESSEN
- TUBE FLEXIBLE RACCORDS COUDÉS
- FLEXIBLE OMEGA

MATERIAL: AISI 316L - 1.4404
[*]: rivestimento / covering / Überzug
revêtement / revestimiento
AISI 304L - 1.4307

O-RING: EPDM nero - black - Schwarz - noir - negro

CODE	De mm	L1 mm	L2 mm	H1 mm	H2 mm	Z mm	g	kg	€
199015001	15	275	165	165	200	20	245	1	-
199018001	18	350	170	170	215	20	290	1	-
199022001	22	380	195	195	236	21	450	1	-
199028001	28	410	230	230	260	23	615	1	-
199035001	35	460	255	255	300	26	1080	1	-
199042001	42	530	295	295	345	30	1455	1	-
199054001	54	625	370	370	410	35	2310	1	-

B1011

199/002

TUBO FLESSIBILE RETTILINEO

- STRAIGHT FLEXIBLE PIPE
- PANZERSCHLAUCH ZUM EINPRESSEN
- TUBE FLEXIBLE RACCORDS DROIT
- FLEXIBLE RECTO

MATERIAL: AISI 316L - 1.4404
[*]: rivestimento / covering / Überzug
revêtement / revestimiento
AISI 304L - 1.4307

O-RING: EPDM nero - black - Schwarz - noir - negro

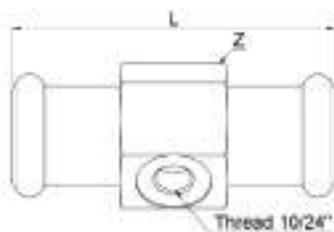

CODE	De mm	L mm	Z mm	g	kg	€
199015002	15	500	20	200	1	-
199018002	18	600	20	310	1	-
199022002	22	700	21	350	1	-
199028002	28	700	23	495	1	-
199035002	35	800	26	980	1	-
199042002	42	900	30	1280	1	-
199054002	54	1100	35	2060	1	-

**195/007 U****B1011****ATTACCO NEBULIZZATORE**

- NEBULIZER CONNECTION
- VERNEBLER-ANSCHLUSS
- CONNEXION NÉBULISEUR
- CONEXIÓN NEBULIZADOR

MATERIAL: AISI 316L – 1.4404**O-RING:** EPDM nero – black – Schwarz – noir – negro

CODE	De mm	L mm	Z mm	Holes Nr.				€
195015017	15	60	24	1 x 10/24"	82	10	200	-
195015027	15	60	24	2 x 10/24"	80	10	200	-

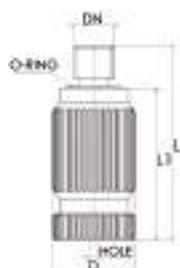
**195/N****B1011****NEBULIZZATORE**

- NEBULIZER
- VERNEBLER
- NÉBULISEUR
- NEBULIZADOR

MATERIAL: AISI 304 – 1.4301**O-RING:** NBR marrone – brown – Braun – brun – marrón

CODE	Hole µm	DN inch	L1 mm	D mm	L mm			€
195000015	15	10/24"	20	9,5	25	10	10	-
195000020	20	10/24"	20	9,5	25	10	10	-
195000030	30	10/24"	20	9,5	25	10	10	-
195000040	40	10/24"	20	9,5	25	10	10	-
195000050	50	10/24"	20	9,5	25	10	10	-

Esempio applicazione art. 195/007 U / Art. 195/007 U application example

195/007 U

Impianti di nebulizzazione con tubazione Ø 15
Atomization systems with Ø 15 pipes

≤54 B1011

76÷108 B1012

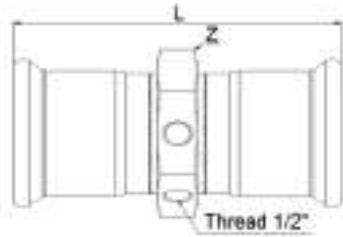

195/007

ATTACCO MULTI STRUMENTO

- MULTIMETER CONNECTION
- MULTI-TOOL-ANSCHLUSS
- CONNEXION MULTI-OUTILLAGE
- CONEXIÓN MULTIPLE HERRAMIENTA

MATERIAL: AISI 316L - 1.4404

O-RING: EPDM nero - black - Schwarz - noir - negro

CODE	De mm	L mm	Z mm	Holes Nr.				€
195035007	35	128	60	3 x 1/2"	715	1	10	-
195042007	42	135	60	3 x 1/2"	645	1	10	-
195054007	54	135	74	3 x 1/2"	874	1	6	-
195076007	76,1	189	92	3 x 1/2"	1474	1	3	-
195088007	88,9	208	106	3 x 1/2"	1874	1	2	-
195108007	108	240	130	3 x 1/2"	2774	1	1	-

Con n° 2 tappi maschi ISO 228 per potere chiudere almeno 2 dei 3 attacchi disponibili da 1/2".
 With n° 2 male caps ISO 228 to close at least 2 of the 3 available attacks of 1/2".
 Mit n° 2 männlich Kappen ISO 228 mindestens 2 der 3 verfügbaren Angriffe von 1/2" zu schließen.
 Avec n° 2 mâle casquettes ISO 228 pour fermer au moins 2 des 3 attaques disponibles de 1/2".
 Con n° 2 casquillos macho ISO 228 para cerrar al menos 2 de los 3 ataques disponibles de 1/2".

Esempio applicazione art. 195/007 / Art. 195/007 application example



195/007 Attacco multi strumento (manometri, termometri, etc)
 Multiple purpose instrument inlet (manometers, thermometers, etc.)

Certificazioni / Certifications

ø 15 ÷ 54 mm			PRODUKTE DER GASVERSORGUNG	DG-8531CL0163 (G 5614)	ø 15 – 54 mm
			EDELSTAHLROHR "INOXPRES" - 1.4404	DV-7301BM 3426 (GW 541)	ø 15 – 108 mm
			UNLÖSBARE ROHRVERBINDUNGEN FÜR METALLENE GASLEITUNGEN PRESSVERBINDER AUS EDELSTAHL FÜR EDELSTAHLROHRE = INOXPRES® GAS=	G 2.827 (PG 500, PG 3149)	ø 15 – 108 mm
			UNLÖSBARE ROHRVERBINDUNGEN PRESSVERBINDUNGS-SYSTEM AUS EDELSTAHL INOXPRES GAS	5-088-06 (G 5614)	ø 15 – 54 mm
			RACCORDI A PRESSARE PER GAS - PLUMBING FITTINGS FOR GASES	CA06-00231	ø 15 – 54 mm
			SYSTEM OF STEEL PIPES AND STEEL COMPRESSION FITTINGS INOXPRES GAS	202/C5a/2019 B-01319-19	ø 15 – 108mm
			STAINLESS STEEL GAS PRESSFITTINGS FOR STAINLESS STEEL PIPES	C-16-3743-A	ø 15 – 54 mm
ø 76 ÷ 108 mm			EDELSTAHLROHR "INOXPRES" - 1.4404	DV-7301BM 3426 (GW 541)	ø 15 – 108 mm
			PRODUKTE DER GASVERSORGUNG	DG-8531CL0163 (G 5614)	ø 76 – 108 mm
			UNLÖSBARE ROHRVERBINDUNGEN FÜR METALLENE GASLEITUNGEN PRESSVERBINDER AUS EDELSTAHL FÜR EDELSTAHLROHRE = INOXPRES® GAS=	G 2.827 (PG 500, PG 314)	ø 15 – 108 mm
			SYSTEM OF STEEL PIPES AND STEEL COMPRESSION FITTINGS INOXPRES GAS	202/C5a/2019 B-01319-19	ø 15 – 108 mm

Campi di applicazione / Fields of application

inoxPRES® GAS



Gas metano / GPL
Natural gas / LPG

inoxPRES® GAS O-ring HNBR-NBR

Giallo | Yellow | Gelb | Jaune | Amarillo

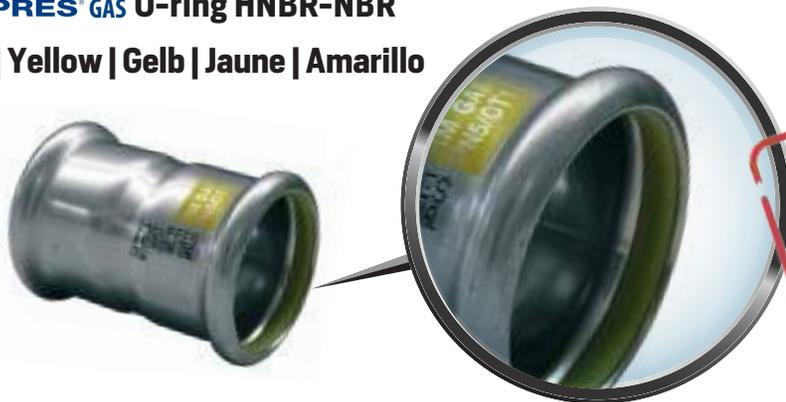

116/200
≤54 B 30 31
76÷108 B 30 32
TUBO PER GAS

- PIPE FOR GAS
- ROHR FÜR GAS
- TUBE POUR LE GAZ
- TUBO PARA EL GAS

NORM: EN 10217-7 (DIN 17455) - EN 10312

Mat. Nr.: 1.4404 (AISI 316L) L=6 m
Crudo - Not annealed - Ungeglüht - Non-hypertrempé - Crudo

CODE	Dimensions mm x mm	Ø int mm	L m	 kg/m	Volume l/m	Minimum package m	Bundle m	€/m
116015200	15 x 1,0	13	6	0,351	0,133	60	1014	-
116018200	18 x 1,0	16	6	0,426	0,201	60	1014	-
116022200	22 x 1,2	19,6	6	0,625	0,302	60	762	-
116028200	28 x 1,2	25,6	6	0,805	0,514	30	546	-
116035200	35 x 1,5	32	6	1,258	0,804	30	546	-
116042200	42 x 1,5	39	6	1,521	1,194	30	366	-
116054200	54 x 1,5	51	6	1,972	2,042	30	366	-
116076200	* 76,1 x 2,0	72,1	6	3,711	4,080	6	114	-
116088200	* 88,9 x 2,0	84,9	6	4,352	5,660	6	114	-
116108200	* 108 x 2,0	104	6	5,308	8,490	6	114	-

[*] DN 76,1-88-108 Solo DVGW-ÖVGW-SZU - Only DVGW-ÖVGW-SZU - Nur DVGW-ÖVGW-SZU - Seulement DVGW-ÖVGW-SZU - Sólo DVGW-ÖVGW-SZU

116/300
≤54 B 30 31
76÷108 B 30 32
TUBO PER GAS

- PIPE FOR GAS
- ROHR FÜR GAS
- TUBE POUR LE GAZ
- TUBO PARA EL GAS

NORM: EN 10217-7 (DIN 17455) - EN 10312

Mat. Nr.: 1.4404 (AISI 316L) L=6 m
Ricotto - Annealed - Geglüht - Hypertrempé - Recocido

CODE	Dimensions mm x mm	Ø int mm	L m	 kg/m	Volume l/m	Minimum package m	Bundle m	€/m
116015300	15 x 1,0	13	6	0,351	0,133	60	1014	-
116018300	18 x 1,0	16	6	0,426	0,201	60	1014	-
116022300	22 x 1,2	19,6	6	0,625	0,302	60	762	-
116028300	28 x 1,2	25,6	6	0,805	0,514	30	546	-
116035300	35 x 1,5	32	6	1,258	0,804	30	546	-
116042300	42 x 1,5	39	6	1,521	1,194	30	366	-
116054300	54 x 1,5	51	6	1,972	2,042	30	366	-
116076300	* 76,1 x 2,0	72,1	6	3,711	4,080	6	114	-
116088300	* 88,9 x 2,0	84,9	6	4,352	5,660	6	114	-
116108300	* 108 x 2,0	104	6	5,308	8,490	6	114	-

[*] DN 76,1-88-108 Solo DVGW-ÖVGW-SZU - Only DVGW-ÖVGW-SZU - Nur DVGW-ÖVGW-SZU - Seulement DVGW-ÖVGW-SZU - Sólo DVGW-ÖVGW-SZU

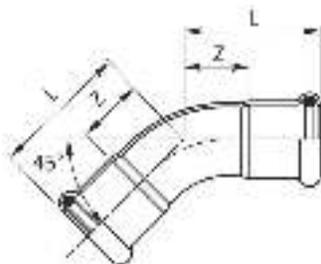
**181/450 G**

≤54 B1013

76÷108 B1014

CURVA 45° FF

- 45° ELBOW FF
- BOGEN 45° II
- COUDE FF 45°
- CURVA 45° HH

MATERIAL: AISI 316L – 1.4404**O-RING:** NBR-HNBR giallo - yellow - Gelb - jaune - amarillo

CODE	De mm	Radius	L mm	Z mm	 g		€
181015450G	15	1,5 De	36	16	50	4	-
181018450G	18	1,5 De	37	17	64	4	-
181022450G	22	1,5 De	41	20	82	4	-
181028450G	28	1,5 De	47	24	112	4	-
181035450G	35	1,2 De	43	17	127	1	-
181042450G	42	1,2 De	51	21	177	1	-
181054450G	54	1,2 De	62	30	273	1	-
181076450G*	76,1	1,2 De	131,5	76,5	900	1	-
181088450G*	88,9	1,2 De	144	84	1250	1	-
181108450G*	108	1,2 De	169	94	1700	1	-

[*] DN 76,1-88-108 Solo DVGW-ÖVGW-SZU - Only DVGW-ÖVGW-SZU - Nur DVGW-ÖVGW-SZU - Seulement DVGW-ÖVGW-SZU - Sólo DVGW-ÖVGW-SZU

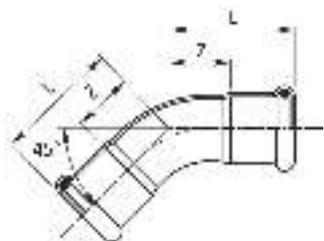
**181/450C G**

B1013

CURVA 45° FF - RAGGIO STRETTO

- 45° ELBOW FF - SHORT RADIUS
- BOGEN 45° II - KURZER RADIUS
- COUDE FF 45° - RAYON COURT
- CURVA 45° HH - RADIO CORTO

MATERIAL: AISI 316L – 1.4404**O-RING:** NBR giallo - yellow - Gelb - jaune - amarillo

CODE	De mm	Radius	L mm	Z mm	 g		€
181015450CG	15	1,2 De	27,5	7,5	39	4	-
181018450CG	18	1,2 De	29,5	9,5	48	4	-
181022450CG	22	1,2 De	32	11	63	4	-
181028450CG	28	1,2 De	37	14	90	4	-

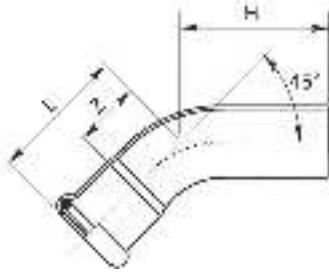

181/451 G

≤54 B 10 13
76÷108 B 10 14

CURVA 45° MF

- 45° ELBOW MF
- BOGEN 45° IA
- COUDE MF 45°
- CURVA 45° HM

MATERIAL: AISI 316L - 1.4404

O-RING: NBR-HNBR giallo - yellow - Gelb - jaune - amarillo

CODE	De mm	Radius	L mm	H mm	Z mm	 g		€
181015451G	15	1,5 De	36	49	16	50	4	-
181018451G	18	1,5 De	37	43	17	64	4	-
181022451G	22	1,5 De	41	48	20	82	4	-
181028451G	28	1,5 De	47	54,5	22	112	4	-
181035451G	35	1,2 De	43	57,5	17	132	1	-
181042451G	42	1,2 De	51	72	21	196	1	-
181054451G	54	1,2 De	62	82	26	296	1	-
181076451G*	76,1	1,2 De	131,5	149	76,5	900	1	-
181088451G*	88,9	1,2 De	144	159	84	1250	1	-
181108451G*	108	1,2 De	169	199	94	1700	1	-

[*] DN 76,1-88-108 Solo DVGW-ÖVGW-SZU - Only DVGW-ÖVGW-SZU - Nur DVGW-ÖVGW-SZU - Seulement DVGW-ÖVGW-SZU - Sólo DVGW-ÖVGW-SZU

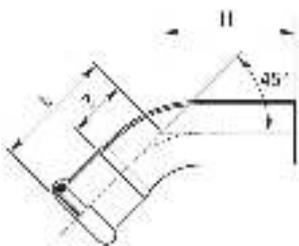

181/451C G

B 10 13

CURVA 45° MF - RAGGIO STRETTO

- 45° ELBOW MF - SHORT RADIUS
- BOGEN 45° IA - KURZER RADIUS
- COUDE MF 45° - RAYON COURT
- CURVA 45° HM - RADIO CORTO

MATERIAL: AISI 316L - 1.4404

O-RING: NBR giallo - yellow - Gelb - jaune - amarillo

CODE	De mm	Radius	L mm	H mm	Z mm	 g		€
181015451CG	15	1,2 De	27,5	36	7,5	38	4	-
181018451CG	18	1,2 De	29,5	38	9,5	47	4	-
181022451CG	22	1,2 De	32	42	11	63	4	-
181028451CG	28	1,2 De	37	46	14	90	4	-

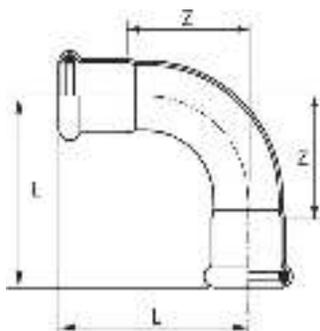
**181/900 G**

≤54 B1013

76÷108 B1014

CURVA 90° FF

- 90° ELBOW FF
- BOGEN 90° II
- COUDE FF 90°
- CURVA 90° HH

MATERIAL: AISI 316L - 1.4404**O-RING:** NBR-HNBR giallo - yellow - Gelb - jaune - amarillo

CODE	De mm	Radius	L mm	Z mm	 g		€
181015900G	15	1,5 De	50	30	58	4	-
181018900G	18	1,5 De	54	34	72	4	-
181022900G	22	1,5 De	60	39	102	4	-
181028900G	28	1,5 De	73	50	143	4	-
181035900G	35	1,2 De	68	42	162	1	-
181042900G	42	1,2 De	80	50	231	1	-
181054900G	54	1,2 De	100	64	367	1	-
181076900G*	76,1	1,2 De	160	105	1150	1	-
181088900G*	88,9	1,2 De	182	122	1580	1	-
181108900G*	108	1,2 De	220	145	2250	1	-

(*) DN 76,1-88-108 Solo DVGW-ÖVGW-SZU - Only DVGW-ÖVGW-SZU - Nur DVGW-ÖVGW-SZU - Seulement DVGW-ÖVGW-SZU - Sólo DVGW-ÖVGW-SZU

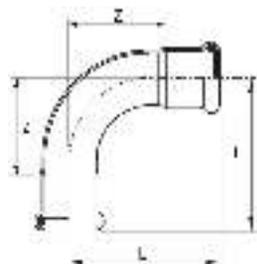
**181/900C G**

B1013

CURVA 90° FF - RAGGIO STRETTO

- 90° ELBOW FF - SHORT RADIUS
- BOGEN 90° II - KURZER RADIUS
- COUDE FF 90° - RAYON COURT
- CURVA 90° HH - RADIO CORTO

MATERIAL: AISI 316L - 1.4404**O-RING:** NBR giallo - yellow - Gelb - jaune - amarillo

CODE	De mm	Radius	L mm	Z mm	 g		€
181015900CG	15	1,2 De	38	18	46	4	-
181018900CG	18	1,2 De	41,5	21,5	58	4	-
181022900CG	22	1,2 De	47	26	78	4	-
181028900CG	28	1,2 De	56	33	116	4	-

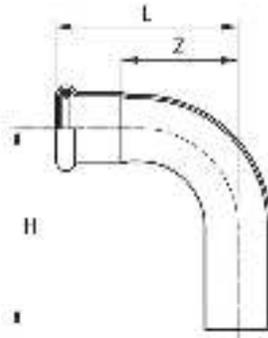
181/901 G
≤54 B 10 13
76÷108 B 10 14
CURVA 90° MF

- 90° ELBOW MF
- BOGEN 90° IA
- COUDE MF 90°
- CURVA 90° HM

MATERIAL: AISI 316L - 1.4404

O-RING: NBR-HNBR giallo - yellow - Gelb - jaune - amarillo

CODE	De mm	Radius	L mm	H mm	Z mm			€
181015901G	15	1,5 De	50	63	30	58	4	-
181018901G	18	1,5 De	54	63	34	72	4	-
181022901G	22	1,5 De	60	71	39	102	4	-
181028901G	28	1,5 De	73	81	50	143	4	-
181035901G	35	1,2 De	68	82	42	176	1	-
181042901G	42	1,2 De	80	101	50	253	1	-
181054901G	54	1,2 De	100	120	64	390	1	-
181076901G*	76,1	1,2 De	160	180	105	1150	1	-
181088901G*	88,9	1,2 De	182	197	122	1580	1	-
181108901G*	108	1,2 De	220	236	145	2250	1	-

[*] DN 76,1-88-108 Solo DVGW-ÖVGW-SZU - Only DVGW-ÖVGW-SZU - Nur DVGW-ÖVGW-SZU - Seulement DVGW-ÖVGW-SZU - Sólo DVGW-ÖVGW-SZU

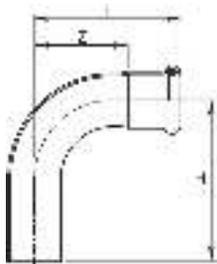

181/901C G
B 10 13
CURVA 90° MF - RAGGIO STRETTO

- 90° ELBOW MF - SHORT RADIUS
- BOGEN 90° IA - KURZER RADIUS
- COUDE MF 90° - RAYON COURT
- CURVA 90° HM - RADIO CORTO

MATERIAL: AISI 316L - 1.4404

O-RING: NBR giallo - yellow - Gelb - jaune - amarillo

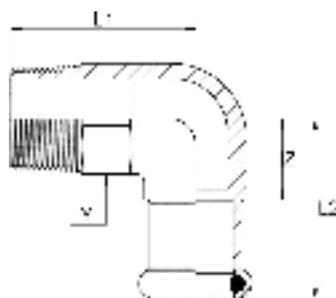
CODE	De mm	Radius	L mm	H mm	Z mm			€
181015901CG	15	1,2 De	38	48	18	46	4	-
181018901CG	18	1,2 De	41,5	48,5	21,5	56	4	-
181022901CG	22	1,2 De	47	57	26	79	4	-
181028901CG	28	1,2 De	56	64	33	115	4	-



197 G

B1013

GOMITO MISTO 90° FILETTO M

- ELBOW ADAPTER 90° WITH MALE THREAD
- ÜBERGANGSWINKEL 90° AG
- EQUERRE 90° AVEC FILETAGE M
- CODO MACHO

MATERIAL: AISI 316L - 1.4404

O-RING: NBR giallo - yellow - Gelb - jaune - amarillo

THREAD: EN 10226-1 (ex ISO 7/1)

CODE	De x R mm x inch	L1 mm	L2 mm	Z mm	Y mm			€
197102015G	15 x 1/2"	37	36	16	22	87	4	-
197102018G	18 x 1/2"	37	36	16	22	93	4	-
197304022G	22 x 3/4"	44	43	22	28	164	4	-
197304028G	28 x 3/4"	44	45	22	28	195	4	-
197100028G	28 x 1"	56	50	27	36	332	4	-
197114035G	35 x 1"1/4	63	76,5	50,5	46	476	1	-
197112042G	42 x 1"1/2	67,5	80	50	50	533	1	-
197200054G	54 x 2"	78,5	91,5	56	65	899	1	-

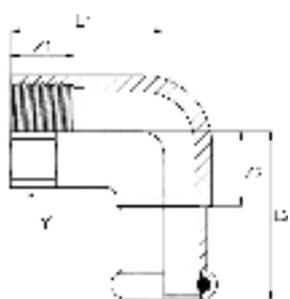

198 G

B1013

GOMITO MISTO 90° FILETTO F

- ELBOW ADAPTER 90° WITH FEMALE THREAD
- ÜBERGANGSWINKEL 90° IG
- EQUERRE 90° AVEC FILETAGE F
- CODO HEMBRA

MATERIAL: AISI 316L - 1.4404

O-RING: NBR giallo - yellow - Gelb - jaune - amarillo

THREAD: EN 10226-1 (ex ISO 7/1)

CODE	De x Rp mm x inch	L1 mm	L2 mm	Z1 mm	Z2 mm	Y mm			€
198102015G	15 x 1/2"	33	36	15	16	24	92	4	-
198102018G	18 x 1/2"	33	36	15	16	24	99	4	-
198304022G	22 x 3/4"	38	43	19	22	30	154	4	-
198102028G	28 x 1/2"	33	39	15	16	24	126	4	-
198100028G	28 x 1"	48	50	21	27	38	309	4	-
198114035G	35 x 1"1/4	48	70,5	21	50,5	46	379	1	-
198112042G	42 x 1"1/2	51	80	21	50	50	390	1	-
198200054G	54 x 2"	66	92	26	56	65	749	1	-

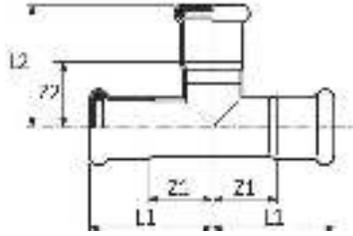
≤54 B 10 13
76÷108 B 10 14

182 G
“T”

- EQUAL TEE
- T-STÜCK
- TÉ ÉGAL
- TE IGUAL HHH

MATERIAL: AISI 316L – 1.4404

O-RING: NBR-HNBR giallo - yellow - Gelb - jaune - amarillo

CODE	De mm	L1 mm	L2 mm	Z1 mm	Z2 mm	 g		€
182015000G	15	34	39	14	19	67	4	-
182018000G	18	37	41	16	21	80	4	-
182022000G	22	39	45	18	24	106	4	-
182028000G	28	44	50	21	27	145	4	-
182035000G	35	51	57	25	31	201	1	-
182042000G	42	59	65	28	35	260	1	-
182054000G	54	70	77	34	42	404	1	-
182076000G*	76,1	108	118	53	63	1275	1	-
182088000G*	88,9	132	131	72	71	1535	1	-
182108000G*	108	155	159	74	84	2115	1	-

[*] DN 76,1-88-108 Solo DVGW-ÖVGW-SZU - Only DVGW-ÖVGW-SZU - Nur DVGW-ÖVGW-SZU - Seulement DVGW-ÖVGW-SZU - Sólo DVGW-ÖVGW-SZU

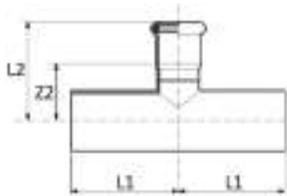
188 G
“T” RIDOTTO MFM

- REDUCING TEE MFM
- T-STÜCK MIT REDUZIERTEM ABGANG A/I/A
- TÉ RÉDUIT MFM
- TE REDUCIDA MHM

MATERIAL: AISI 316L – 1.4404

O-RING: NBR giallo - yellow - Gelb - jaune - amarillo

B 10 13

CODE	De mm	L1 mm	L2 mm	Z2 mm	 g		€
188028022G	28 x 22 x 28	52,5	47	26	138	4	-
188035022G	35 x 22 x 35	60	50,5	29,5	181	1	-
188035028G	35 x 28 x 35	60	53,5	30,5	193	1	-
188042028G	42 x 28 x 42	69	57	34	256	1	-
188054028G	54 x 28 x 28	73,5	64,5	41,5	334	1	-

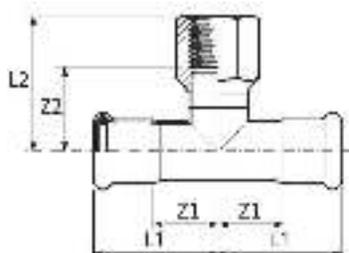

189 G

≤54 B1013

76÷108 B1014

"T" CON DERIVAZIONE FILETTO F

- BRANCH TEE FEMALE BSP OUTLET
- T-STÜCK MIT ABGANG IG
- TÉ MIXTE AVEC FILETAGE F
- TE HEMBRA ROSCADA

MATERIAL: AISI 316L - 1.4404

O-RING: NBR-HNBR giallo - yellow - Gelb - jaune - amarillo

THREAD: EN 10226-1 (ex ISO 7/1)

CODE	De x Rp x De mm x inch x mm	L1 mm	L2 mm	Z1 mm	Z2 mm			€
189102015G **	15 x 1/2" x 15	36,5	22,5	16,5	8,5	117	4	-
189102018G **	18 x 1/2" x 18	36	24	16	10	128	4	-
189304018G **	18 x 3/4" x 18	38,5	26	18,5	11	147	4	-
189102022G **	22 x 1/2" x 22	39	26	18	12	159	4	-
189304022G **	22 x 3/4" x 22	41,5	30	20,5	14	184	4	-
189102028G **	28 x 1/2" x 28	44	29	21	15	217	4	-
189304028G **	28 x 3/4" x 28	44	30	21	14	221	4	-
189102035G	35 x 1/2" x 35	51	51	25	36	197	1	-
189304035G	35 x 3/4" x 35	51	54	25	37	205	1	-
189102042G	42 x 1/2" x 42	59	54	29	39	271	1	-
189304042G	42 x 3/4" x 42	59	57	29	41	277	1	-
189102054G	54 x 1/2" x 54	70	61	34	46	377	1	-
189304054G	54 x 3/4" x 54	70	64	34	48	391	1	-
189200054G	54 x 2" x 54	70	81	34	55	838	1	-
189304076G*	76,1 x 3/4" x 76,1	108	77	53	60	1040	1	-
189200076G*	76,1 x 2" x 76,1	108	93	53	67	1495	1	-
189304088G*	88,9 x 3/4" x 88,9	132	84	72	67	1255	1	-
189200088G*	88,9 x 2" x 88,9	132	100	72	74	1720	1	-
189304108G*	108 x 3/4" x 108	155	94	74	77	1700	1	-
189200108G*	108 x 2" x 108	155	110	74	84	2160	1	-

(*) DN 76,1-88-108 Solo DVGW-ÖVGW-SZU - Only DVGW-ÖVGW-SZU - Nur DVGW-ÖVGW-SZU - Seulement DVGW-ÖVGW-SZU - Sólo DVGW-ÖVGW-SZU
 (**) senza saldatura - seamless - nahtlos - sans soudure - sin soldadura

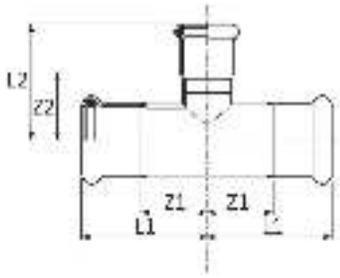
192 G
≤54 B 10 13
76÷108 B 10 14
“T” RIDOTTO

- REDUCING TEE
- T-STÜCK MIT REDUZIERTEM ABGANG
- TÉ RÉDUIT
- TE REDUCIDA HHH

MATERIAL: AISI 316L - 1.4404

O-RING: NBR-HNBR giallo - yellow - Gelb - jaune - amarillo

CODE	De mm	L1 mm	L2 mm	Z1 mm	Z2 mm			€
192018015G	18 x 15 x 18	37	41	16	21	80	4	-
192022015G	22 x 15 x 22	39	43	18	23	95	4	-
192022018G	22 x 18 x 22	39	44	18	23	98	4	-
192028015G	28 x 15 x 28	44	46	21	26	126	4	-
192028018G	28 x 18 x 28	44	46	21	26	130	4	-
192028022G	28 x 22 x 28	44	47	21	26	135	4	-
192035015G	35 x 15 x 35	51	49	25	29	158	1	-
192035018G	35 x 18 x 35	51	50	25	30	163	1	-
192035022G	35 x 22 x 35	51	51	25	30	167	1	-
192035028G	35 x 28 x 35	51	54	25	31	171	1	-
192042022G	42 x 22 x 42	59	54	29	33	237	1	-
192042028G	42 x 28 x 42	59	57	29	34	243	1	-
192042035G	42 x 35 x 42	59	61	29	35	272	1	-
192054022G	54 x 22 x 54	70	62	34	41	340	1	-
192054028G	54 x 28 x 54	70	65	34	42	345	1	-
192054035G	54 x 35 x 54	70	68	34	42	361	1	-
192054042G	54 x 42 x 54	70	72	34	42	376	1	-
192076054G*	76,1 x 54 x 76,1	108	90	53	55	1065	1	-
192088028G*	88,9 x 28 x 88,9	132	84	72	61	1225	1	-
192088054G*	88,9 x 54 x 88,9	132	97	72	62	1280	1	-
192088076G*	88,9 x 76,1 x 88,9	132	125	72	70	1485	1	-
192108028G*	108 x 28 x 108	155	94	74	71	1670	1	-
192108076G*	108 x 76,1 x 108	155	135	74	80	1930	1	-
192108088G*	108 x 88,9 x 108	155	141	74	81	1965	1	-

[*] DN 76,1-88-108 Solo DVGW-ÖVGW-SZU - Only DVGW-ÖVGW-SZU - Nur DVGW-ÖVGW-SZU - Seulement DVGW-ÖVGW-SZU - Sólo DVGW-ÖVGW-SZU

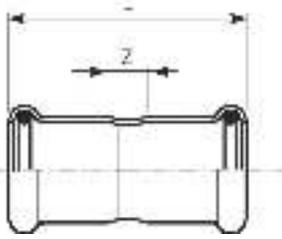
**183/000 G**

≤54 B1013

76÷108 B1014

MANICOTTO

- COUPLING
- MUFFE
- MANCHON
- MANGUITO HH

MATERIAL: AISI 316L – 1.4404**O-RING:** NBR-HNBR giallo - yellow - Gelb - jaune - amarillo

CODE	De mm	L mm	Z mm			€
183015000G	15	49	9	35	4	-
183018000G	18	50	10	42	4	-
183022000G	22	53	11	54	4	-
183028000G	28	56	10	71	4	-
183035000G	35	63	10	97	1	-
183042000G	42	72	12	136	1	-
183054000G	54	83	13	198	1	-
183076000G*	76,1	142	32	635	1	-
183088000G*	88,9	166	46	765	1	-
183108000G*	108	203	41	1170	1	-

[*] DN 76,1-88-108 Solo DVGW-ÖVGW-SZU - Only DVGW-ÖVGW-SZU - Nur DVGW-ÖVGW-SZU - Seulement DVGW-ÖVGW-SZU - Sólo DVGW-ÖVGW-SZU

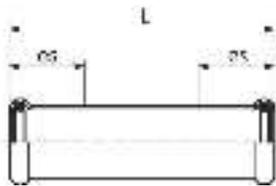
**183/001 G**

≤54 B1013

76÷108 B1014

**MANICOTTO
PASSANTE**

- SLIP COUPLING
- SCHIEBEMUFFE
- MANCHON LONG
- MANGUITO SIN TOPE

MATERIAL: AISI 316L – 1.4404**O-RING:** NBR-HNBR giallo - yellow - Gelb - jaune - amarillo

CODE	De mm	L mm	es mm			€
183015001G	15	69	25	56	4	-
183018001G	18	73	25	65	4	-
183022001G	22	79	25	85	4	-
183028001G	28	88,5	30	118	4	-
183035001G	35	102,5	30	141	1	-
183042001G	42	117,5	40	234	1	-
183054001G	54	139	40	321	1	-
183076001G*	76,1	230	60	940	1	-
183088001G*	88,9	260	70	1240	1	-
183108001G*	108	310	80	1835	1	-

[*] DN 76,1-88-108 Solo DVGW-ÖVGW-SZU - Only DVGW-ÖVGW-SZU - Nur DVGW-ÖVGW-SZU - Seulement DVGW-ÖVGW-SZU - Sólo DVGW-ÖVGW-SZU

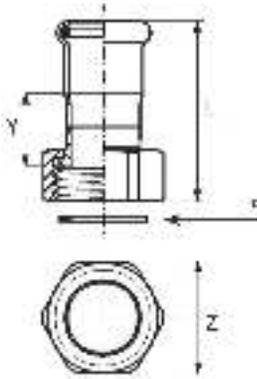
B 10 13

183/002 G
MANICOTTO CON DADO FOLLE

- VALVE CONNECTOR
- ANSCHLUSSVERSCHRAUBUNG
- RACCORD ÉCROU LIBRE
- RÁCOR DOS PIEZAS

MATERIAL: AISI 316L - 1.4404

O-RING: NBR giallo - yellow - Gelb - jaune - amarillo

GASKET: [*]: HNBR giallo - yellow - Gelb - jaune - amarillo

THREAD: ISO 228/1 (ex DIN 259)

CODE	De x G mm x inch	L mm	Z mm	Y mm	Gasket mm	g	€
183015012G	15 x 1/2"	48,5	27	23	18x10 thk 2,5	83	4
183015002G	15 x 3/4"	56	30	26	24x14 thk 2,5	66	4
183018012G	18 x 1/2"	49	27	23,5	18x10 thk 2,5	91	4
183018002G	18 x 3/4"	50	30	23	24x14 thk 2,5	65	4
183022012G	22 x 3/4"	50	30	19,5	24x14 thk 2,5	78	4
183022002G	22 x 1"	52	35	23	30x20 thk 2,5	87	4
183028012G	28 x 1"	52	36	19,5	30x20 thk 2,5	105	4
183028002G	28 x 1 1/4"	57	46	25	39x27 thk 2,5	136	4
183035012G	35 x 1 1/4"	57,5	46	20,5	39x27 thk 2,5	163	1
183035002G	35 x 1 1/2"	63	52	26	44,5x34 thk 2,5	186	1
183042022G	42 x 1 1/2"	63,5	52	21	44,5x34 thk 2,5	217	1
183042012G	42 x 1 3/4"	68	58	27	50,5x40 thk 2,5	223	1
183042002G	42 x 2"	68	64	27	56x42 thk 2,5	266	1
183054022G	54 x 2"	72	67	23	56x42 thk 2,5	301	1
183054012G	54 x 2 3/8"	77	75	30	65,5x53,5 thk 3	375	1
183054002G	54 x 2 1/2"	77	81	30	71,5x53 thk 3	439	1

183/003 G
TAPPO DI CHIUSURA

- STOP END
- VERSCHLUSSKAPPE
- BOUCHON D'OBTURATION
- TAPÓN

MATERIAL: AISI 316L - 1.4404

O-RING: NBR-HNBR giallo - yellow - Gelb - jaune - amarillo

≤54 B 10 13
76÷108 B 10 14

CODE	De mm	L mm	L1 mm	g	€
183015003G	15	44	24	32	4
183018003G	18	44	24	38	4
183022003G	22	45	24	51	4
183028003G	28	48	25	68	4
183035003G	35	52	26	95	1
183042003G	42	56	26	126	1
183054003G	54	62	27	185	1
183076003G*	76,1	93	38	540	1
183088003G*	88,9	99	39	630	1
183108003G*	108	117	42	935	1

[*] DN 76,1-88-108 Solo DVGW-ÖVGW-SZU - Only DVGW-ÖVGW-SZU - Nur DVGW-ÖVGW-SZU - Seulement DVGW-ÖVGW-SZU - Sólo DVGW-ÖVGW-SZU

B1013

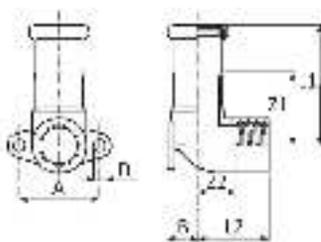

185/000 G

GOMITO MISTO 90° FF

- WALL PLATE ELBOW 90° FF
- DECKENWINKEL 90° I/I
- EQUERRE 90° FF
- CODO PLACA HH

MATERIAL: AISI 316L - 1.4404

O-RING: NBR giallo - yellow - Gelb - jaune - amarillo

THREAD: EN 10226-1 (ex ISO 7/1)

CODE	De x Rp mm x inch	L1 mm	L2 mm	Z1 mm	Z2 mm	A mm	B mm	D mm			€
185102015G	15 x 1/2"	50	30	30	17	34	13	5	98	4	-
185102018G	18 x 1/2"	51	30	31	17	34	13	5	109	4	-
185304022G	22 x 3/4"	55	34	34	19	40	17	6	166	4	-

B1013

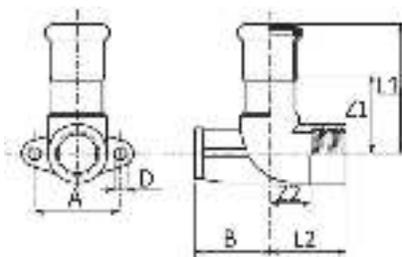

185/001 G

GOMITO MISTO 90° FF CON DISTANZIALE

- EXTENSION WALL PLATE ELBOW 90° FF
- DECKENWINKEL 90°/W - I/I
- EQUERRE 90° FF AVEC SUPPORT D'AVANCEMENT
- CODO PLACA HH CON ESPACIADOR

MATERIAL: AISI 316L - 1.4404

O-RING: NBR giallo - yellow - Gelb - jaune - amarillo

THREAD: EN 10226-1 (ex ISO 7/1)

CODE	De x Rp mm x inch	L1 mm	L2 mm	Z1 mm	Z2 mm	A mm	B mm	D mm			€
185100122G	22 x 1"	59	35	38	15	50	30	6,5	252	4	-
185100128G	28 x 1"	62	35	39	15	50	30	6,5	264	4	-

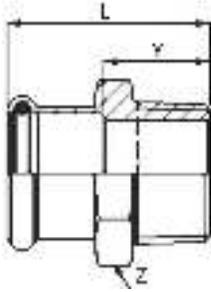
187 G
≤54 B 10 13
76÷108 B 10 14
**MANICOTTO MISTO
FILETTO M**

- MALE ADAPTER
- ÜBERGANGSSTÜCK MIT AG
- RACCORD AVEC FILETAGE MALE
- UNIÓN MACHO

MATERIAL: AISI 316L - 1.4404

O-RING: NBR-HNBR giallo - yellow - Gelb -
jaune - amarillo

THREAD: EN 10226-1 (ex ISO 7/1)

CODE	De x R mm x inch	L mm	Z mm	Y mm			€
187308015G	15 x 3/8"	38	24	18	46	4	-
187102015G	15 x 1/2"	41	24	21	54	4	-
187304015G	15 x 3/4"	43	30	23	101	4	-
187102018G	18 x 1/2"	41	27	21	58	4	-
187304018G	18 x 3/4"	44	30	24	94	4	-
187102022G	22 x 1/2"	42	32	21	83	4	-
187304022G	22 x 3/4"	44	32	23	89	4	-
187100022G	22 x 1"	46	36	25	154	4	-
187304028G	28 x 3/4"	47	38	24	114	4	-
187100028G	28 x 1"	48	38	25	123	4	-
187114028G	28 x 1 1/4"	53	46	30	248	4	-
187100035G	35 x 1"	52	45	25	173	1	-
187114035G	35 x 1 1/4"	55	46	28	180	1	-
187112035G	35 x 1 1/2"	55	50	28	278	1	-
187114042G	42 x 1 1/4"	59	54	28	240	1	-
187112042G	42 x 1 1/2"	59	55	28	236	1	-
187112054G	54 x 1 1/2"	65	65	29	356	1	-
187200054G	54 x 2"	71	65	35	362	1	-
187212076G*	76,1 x 2 1/2"	98	83	43	769	1	-
187300088G*	88,9 x 3"	111	98	51	1218	1	-
187400108G*	108 x 4"	132	118	57	1842	1	-

[*] DN 76,1-88-108 Solo DVGW-ÖVGW-SZU - Only DVGW-ÖVGW-SZU - Nur DVGW-ÖVGW-SZU - Seulement DVGW-ÖVGW-SZU - Sólo DVGW-ÖVGW-SZU

B1013

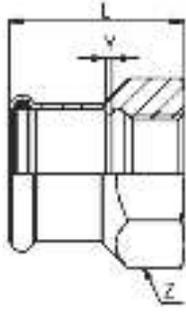

190 G

MANICOTTO MISTO FILETTO F

- FEMALE ADAPTER
- ÜBERGANGSSTÜCK MIT IG
- RACCORD AVEC FILETAGE FEMELLE
- UNIÓN HEMBRA

MATERIAL: AISI 316L - 1.4404

O-RING: NBR giallo - yellow - Gelb - jaune - amarillo

THREAD: EN 10226-1 (ex ISO 7/1)

CODE	De x Rp mm x inch	L mm	Z mm	Y mm			€
190102015G	15 x 1/2"	38	27	2	64	4	-
190304015G	15 x 3/4"	39	32	2	75	4	-
190102018G	18 x 1/2"	38	27	2	89	4	-
190304018G	18 x 3/4"	39	32	2	80	4	-
190102022G	22 x 1/2"	39	32	2	99	4	-
190304022G	22 x 3/4"	40	32	2	82	4	-
190100022G	22 x 1"	43	41	2	148	4	-
190304028G	28 x 3/4"	42	38	2	130	4	-
190100028G	28 x 1"	45	41	2	158	4	-
190114028G	28 x 1 1/4"	48	46	2	148	4	-
190100035G	35 x 1"	49	46	2	216	1	-
190114035G	35 x 1 1/4"	52	46	2	170	1	-
190112035G	35 x 1 1/2"	52	55	2	284	1	-
190114042G	42 x 1 1/4"	56	55	2	259	1	-
190112042G	42 x 1 1/2"	56	55	2	243	1	-
190112054G	54 x 1 1/2"	60	65	1	420	1	-
190200054G	54 x 2"	65	65	2	314	1	-

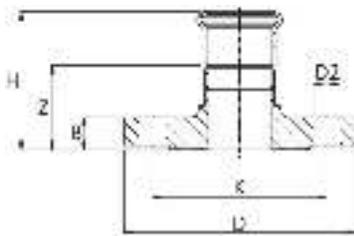

193 G

MANICOTTO FLANGIATO

- ADAPTOR FLANGE
- ÜBERGANGSFLANSCH
- BRIDE DE RACCORDEMENT
- BRIDA ADAPTADOR

MATERIAL: AISI 316L - 1.4404

O-RING: NBR-HNBR giallo - yellow - Gelb - jaune - amarillo

PN 16

≤54 B 10 13

76÷108 B 10 14

CODE	De mm	DN flg	H mm	Z mm	B mm	D mm	D2 mm	Holes Nr.	K mm			€
193015000G	15	15	55	35	14	95	14	4	65	660	1	-
193018000G	18	15	55,5	35,5	14	95	14	4	65	660	1	-
193022000G	22	20	58,5	37,5	16	105	14	4	75	945	1	-
193028000G	28	25	61,5	38,5	16	115	14	4	85	1140	1	-
193035000G	35	32	65,5	39,5	16	140	18	4	100	1640	1	-
193042000G	42	40	69	39	16	150	18	4	110	1800	1	-
193054000G	54	50	78	42	18	165	18	4	125	2450	1	-
193076000G*	76,1	65	105	50	18	185	18	4	145	3184	1	-
193088000G*	88,9	80	116	56	20	200	18	8	160	3950	1	-
193108000G*	108	100	132	57	20	220	18	8	180	4729	1	-

[*] DN 76,1-88-108 Solo DVGW-ÖVGW-SZU - Only DVGW-ÖVGW-SZU - Nur DVGW-ÖVGW-SZU - Seulement DVGW-ÖVGW-SZU - Sólo DVGW-ÖVGW-SZU

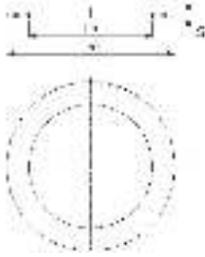

434/PN10-16 GAS

R 30 30

GUARNIZIONE ECOLOGICA PER FLANGE

- GASKET FOR FLANGE
- FLANSCHDICHTUNG
- JOINT POUR BRIDE
- JUNTA ECOLÓGICA PARA BRIDA

**PN
10/16**

MATERIAL: NA 1100 - asbestos free
NORM: EN 1092-1

CODE	DN	De mm	Di mm	S mm			€
434015000G	15 - [1/2"]	50	20	2	6	10	-
434020000G	20 - [3/4"]	60	25	2	8	10	-
434025000G	25 - [1"]	70	30	2	10	10	-
434032000G	32 - [1 1/4"]	82	38	2	14	10	-
434040000G	40 - [1 1/2"]	92	45	2	17	10	-
434050000G	50 - [2"]	108	57	2	22	10	-
434065000G	65 - [2 1/2"]	127	76	2	27	10	-
434080000G	80 - [3"]	142	89	2	30	10	-
434100000G	100 - [4"]	162	108	2	38	10	-

NA 1100 - esente amianto: fibre di carbonio e grafite legate con gomma NBR indicata per uso universale con alte temperature e pressioni elevate.

IMPIEGHI: adatta per la tenuta con i derivati del petrolio, acqua, vapori saturi, solventi, gas e prodotti chimici in generale

LIMITI DI IMPIEGO ORIENTATIVI

Standard 250°C / 70 bar

Vapore saturo 250°C / 40 bar

Massimi 450°C / 130 bar

OMOLOGAZIONI: DVGW per tenuta gas secondo DIN 3535 p. 6 - KTW per guarnizioni a contatto con acqua potabile

NA 1100 - asbestos-free: carbon fibers and graphite bonded with NBR rubber suitable for universal use with high temperatures and high pressures.

APPLICATIONS: suitable for sealing with petroleum derivatives, water, saturated steam, solvents, gases and chemical products in general.

GUIDELINE LIMITS

Standard 250° C / 70 bar

Saturated steam 250° C / 40 bar

Maximum 450° C / 130 bar

APPROVALS: DVGW for gas -DIN 3535 p. 6 - KTW for gaskets in contact with drinking water

B1013

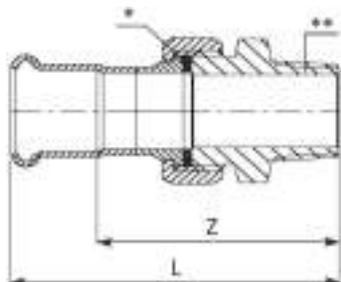

184/002 G

BOCCHETTONE SEDE PIANA FILETTO M

- STRAIGHT MALE UNION CONNECTOR
- DURCHGANGSVERSCHRAUBUNG MIT AUSSENGEWINDE
- RACCORD UNION FILETÉ
- RÁCOR 3 PIEZAS ROSCADO MACHO

MATERIAL: AISI 316L - 1.4404

FITTING: (**): ottone - brass - Messing - laiton - latón

O-RING: NBR giallo - yellow - Gelb - jaune - amarillo

GASKET: (*): HNBR giallo - yellow - Gelb - jaune - amarillo

THREAD: EN 10226-1 (ex ISO 7/1)

CODE	De x R mm x inch	L mm	Z mm	Gasket mm			€
184015002G	15 x 1/2"	76	56	24x14 thk 2,5	142	4	-
184018002G	18 x 1/2"	77	56	24x14 thk 2,5	144	4	-
184022122G	22 x 1/2"	79	54	30x20 thk 2,5	199	4	-
184022002G	22 x 3/4"	81	59	30x20 thk 2,5	202	4	-
184028342G	28 x 3/4"	87	64	39x27 thk 2,5	370	4	-
184028002G	28 x 1"	90	67	39x27 thk 2,5	364	1	-
184035002G	35 x 1 1/4"	101	74	44,5x34 thk 2,5	540	1	-
184042002G	42 x 1 1/2"	105	74	50,5x40 thk 2,5	563	1	-
184054002G	54 x 2"	118	83	65,5x53,5 thk 3	823	1	-

B1013

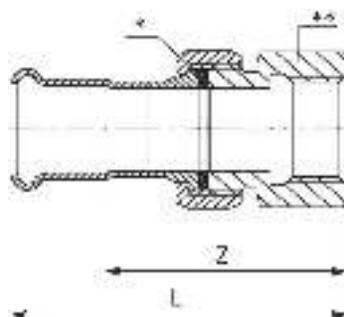

184/003 G

BOCCHETTONE SEDE PIANA FILETTO F

- STRAIGHT FEMALE UNION CONNECTOR
- DURCHGANGSVERSCHRAUBUNG MIT INNENGEWINDE
- RACCORD UNION TARAUDÉ
- RÁCOR 3 PIEZAS HEMBRA

MATERIAL: AISI 316L - 1.4404

FITTING: (**): ottone - brass - Messing - laiton - latón

O-RING: NBR giallo - yellow - Gelb - jaune - amarillo

GASKET: (*): HNBR giallo - yellow - Gelb - jaune - amarillo

THREAD: EN 10226-1 (ex ISO 7/1)

CODE	De x Rp mm x inch	L mm	Z mm	Gasket mm			€
184015003G	15 x 1/2"	71	50	24x14 thk 2,5	140	4	-
184018003G	18 x 1/2"	72	51	24x14 thk 2,5	145	4	-
184022123G	22 x 1/2"	75	54	30x20 thk 2,5	253	4	-
184022003G	22 x 3/4"	76	54	30x20 thk 2,5	213	4	-
184028343G	28 x 3/4"	83	60	39x27 thk 2,5	483	4	-
184028003G	28 x 1"	83	60	39x27 thk 2,5	404	4	-
184035003G	35 x 1 1/4"	93	66	44,5x34 thk 2,5	486	1	-
184042003G	42 x 1 1/2"	97	66	50,5x40 thk 2,5	536	1	-
184054003G	54 x 2"	116	81	65,5x53,5 thk 3	1091	1	-

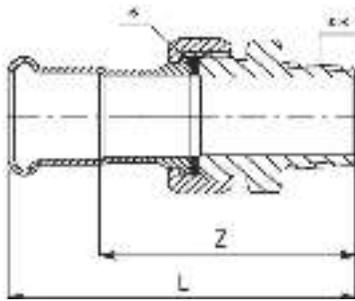
B 10 13

184/002 INOX G

BOCCHETTONE SEDE PIANA FILETTO M

- STRAIGHT MALE UNION CONNECTOR
- DURCHGANGSVERSCHRAUBUNG MIT AUSSENGEWINDE
- RACCORD UNION FILETÉ
- RÁCOR 3 PIEZAS ROSCADO MACHO

MATERIAL: AISI 316L - 1.4404

FITTING: [**]: AISI 316L - 1.4404

O-RING: NBR giallo - yellow - Gelb - jaune - amarillo

GASKET: [*]: HNBR giallo - yellow - Gelb - jaune - amarillo

THREAD: EN 10226-1 (ex ISO 7/1)

CODE	De x R mm x inch	L mm	Z mm	Gasket mm			€
184015002IG	15 x 1/2"	77	56	24x14 thk 2,5	137	4	-
184018002IG	18 x 1/2"	77	56	24x14 thk 2,5	139	4	-
184022002IG	22 x 3/4"	81	59	30x20 thk 2,5	194	4	-
184028002IG	28 x 1"	90	67	39x27 thk 2,5	350	4	-
184035002IG	35 x 1 1/4"	101	74	44,5x34 thk 2,5	518	1	-

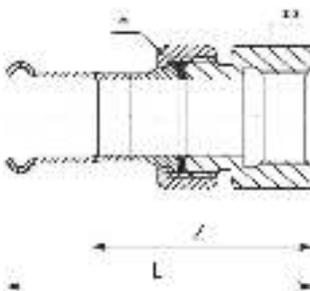
B 10 13

184/003 INOX G

BOCCHETTONE SEDE PIANA FILETTO F

- STRAIGHT FEMALE UNION CONNECTOR
- DURCHGANGSVERSCHRAUBUNG MIT INNENGEWINDE
- RACCORD UNION TARAUDÉ
- RÁCOR 3 PIEZAS HEMBRA

MATERIAL: AISI 316L - 1.4404

FITTING: [**]: AISI 316L - 1.4404

O-RING: NBR giallo - yellow - Gelb - jaune - amarillo

GASKET: [*]: HNBR giallo - yellow - Gelb - jaune - amarillo

THREAD: EN 10226-1 (ex ISO 7/1)

CODE	De x Rp mm x inch	L mm	Z mm	Gasket mm			€
184015003IG	15 x 1/2"	71	50	24x14 thk 2,5	135	4	-
184018003IG	18 x 1/2"	72	51	24x14 thk 2,5	140	4	-
184022003IG	22 x 3/4"	76	54	30x20 thk 2,5	206	4	-
184028003IG	28 x 1"	83	60	39x27 thk 2,5	387	4	-
184035003IG	35 x 1 1/4"	93	66	44,5x34 thk 2,5	467	1	-

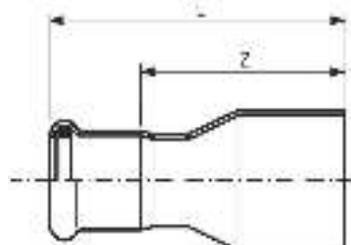
**191 G**

≤54 B1013

76÷108 B1014

RIDUZIONE MF

- REDUCER
- REDUZIERSTÜCK
- REDUCTION
- REDUCCIÓN MH

MATERIAL: AISI 316L – 1.4404**O-RING:** NBR-HNBR giallo - yellow - Gelb - jaune - amarillo

CODE	De mm	L mm	Z mm			€
191018015G	18 x 15	57	37	35	4	-
191022015G	22 x 15	64	44	43	4	-
191022018G	22 x 18	60	40	47	4	-
191028015G	28 x 15	76,5	56,5	50	4	-
191028018G	28 x 18	68	48	63	4	-
191028022G	28 x 22	65	44	66	4	-
191035015G	35 x 15	87	67	89	1	-
191035018G	35 x 18	81	61	87	1	-
191035022G	35 x 22	70	49	90	1	-
191035028G	35 x 28	71	48	98	1	-
191042015G	42 x 15	91	71	111	1	-
191042018G	42 x 18	92	72	114	1	-
191042022G	42 x 22	97	76	120	1	-
191042028G	42 x 28	93	70	130	1	-
191042035G	42 x 35	81	55	138	1	-
191054015G	54 x 15	103	83	158	1	-
191054018G	54 x 18	103	83	162	1	-
191054022G	54 x 22	104	83	169	1	-
191054028G	54 x 28	108,5	85,5	180	1	-
191054035G	54 x 35	108	82	193	1	-
191054042G	54 x 42	97,5	67,5	210	1	-
191076054G*	76,1 x 54	159	124	529	1	-
191088054G*	88,9 x 54	179	144	683	1	-
191088076G*	88,9 x 76,1	186	131	813	1	-
191108054G*	108 x 54	185	150	831	1	-
191108076G*	108 x 76,1	209	154	1022	1	-
191108088G*	108 x 88,9	210	150	1107	1	-

[*] DN 76,1-88-108 Solo DVGW-OVGW - Only DVGW-OVGW - Nur DVGW-OVGW - Seulement DVGW-OVGW - Sólo DVGW-OVGW

B1013**185/CON****PIASTRA SUPPORTO CONTATORE**

- SUPPORT PLATE FOR GAS METER
- GASZÄHLERANSCHLUSS-GRUNDPLATTE
- SUPPORT DE COMPTEUR À GAZ
- SOPORTE CONTADOR DA GAS

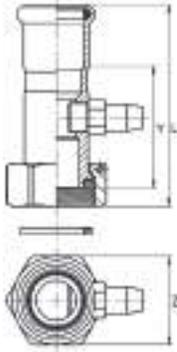

CODE	Dimensions mm x mm			€
185000CONG	90 x 345	535	1	-

183/GP G
B 10 13
RACCORDO 2 PEZZI CON PRESA DI PRESSIONE

- 2 PCS VALVE CONNECTOR PRESSION OUTLET
- ANSCHLU.2P/DRUCKAUSGANG
- RACCORD 2P AVEC SORTIE PRESSION
- RÁCOR 2P PRECINTABLE C/PURGADOR

MATERIAL: AISI 316L - 1.4404

O-RING: NBR giallo - yellow - Gelb - jaune - amarillo

GASKET: NBR giallo - yellow - Gelb - jaune - amarillo

THREAD: ISO 228/1 [ex DIN 259]

CODE	De x G mm x inch	L mm	Z mm	Y mm			€
183015304GP	15 x 3/4"	70	29	44	112	4	-
183015708GP	15 x 7/8"	74	34	47	160	4	-
183018304GP	18 x 3/4"	70	29	44,5	114	4	-
183018708GP	18 x 7/8"	74,5	34	47,5	156	4	-
183022304GP	22 x 3/4"	69,5	29	43	120	4	-
183022708GP	22 x 7/8"	73,5	34	45,5	149	4	-

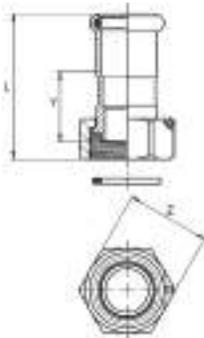
183/GD G
B 10 13
RACCORDO 2 PEZZI CON DADO FOLLE

- 2 PCS VALVE CONNECTOR
- ANSCHLUSSVERSCHRAUBUNG
- RACCORD 2 PC/ÉCROU LIBRE
- RÁCOR 2P PRECINTABLE

MATERIAL: AISI 316L - 1.4404

O-RING: NBR giallo - yellow - Gelb - jaune - amarillo

GASKET: NBR giallo - yellow - Gelb - jaune - amarillo

THREAD: ISO 228/1 [ex DIN 259]

CODE	De x G mm x inch	L mm	Z mm	Y mm			€
183015020GD	15 x M20	51	24	24	54	4	-
183015102GD	15 x 1/2"	49	24	24	53	4	-
183018102GD	18 x 1/2"	48	24	23,5	56	4	-
183018304GD	18 x 3/4"	52	29	27,5	74	4	-
183018708GD	18 x 7/8"	55	34	28	98	4	-
183022304GD	22 x 3/4"	51,5	29	26	79	4	-
183022708GDA	22 x 7/8"	56,5	34	28,5	108	4	-
183028708GDA	28 x 7/8"	57	34	27	116	4	-
183028100GD	28 x 1"	58	36	28	119	4	-
183035114GD	35 x 1 1/4"	62,5	45	28,5	180	1	-
183042112GD	42 x 1 1/2"	73	52	33	266	1	-
183054200GD	54 x 2"	81	64	34,5	417	1	-

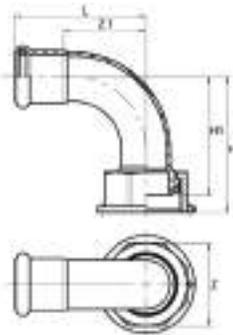
**183/GC G****B1013****RACCORDO CURVO 90° 2 PEZZI**

- 2 PCS VALVE CONNECTOR 90°
- ANSCHLUSSVERSCHRAUBUNG 90°
- RACCORD ÉCROU LIBRE 90° 2PC
- RÁCOR 90° 2P PRECINTABLE

MATERIAL: AISI 316L - 1.4404**O-RING:** NBR giallo - yellow - Gelb - jaune - amarillo**GASKET:** NBR giallo - yellow - Gelb - jaune - amarillo**THREAD:** ISO 228/1 (ex DIN 259)

CODE	De x G mm x inch	L mm	Z mm	Z1 mm	H mm	H1 mm			€
183018708GC	18 x 7/8"	54	34	34	52,5	45,5	126	4	-
183022708GC	22 x 7/8"	60	34	39	59	52	149	4	-

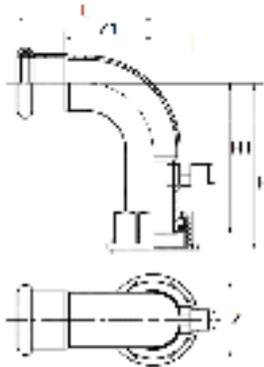
**183/GCP G****B1013****RACCORDO CURVO 90° 2 PEZZI CON PRESA PRESSIONE**

- 2 PCS VALVE CONNECTOR 90° PRESSION OUTLET
- ANSCHLUSSVERSCHRAUBUNG 90° MIT DRUCKAUSGANG
- RACCORD ÉCROU LIBRE 90° 2PC AVEC SORTIE PRESSION
- RÁCOR 90° 2P PRECINTABLE C/PURGADOR

MATERIAL: AISI 316L - 1.4404**O-RING:** NBR giallo - yellow - Gelb - jaune - amarillo**GASKET:** NBR giallo - yellow - Gelb - jaune - amarillo**THREAD:** ISO 228/1 (ex DIN 259)

CODE	De x G mm x inch	L mm	Z mm	Z1 mm	H mm	H1 mm			€
183018708GCP	18 x 7/8"	54	34	34	72	65	184	4	-
183022708GCP	22 x 7/8"	60	34	39	76	69	190	4	-

inoxPRES® GAS Guarnizione / Gasket NBR
Giallo | Yellow | Gelb | Jaune | Amarillo

Particolare sede tenuta attacco contatore
 Particular seal of gas meter fitting
 art. 183/GP G - 183/GD G - 183/GC G - 183/GC G

Campi di applicazione / Fields of application

inoxPRES® HT FREE SILICONE



Aria compressa
Compressed air



Ossigeno industriale O₂
Industrial oxygen O₂



Ozono O₃
Ozone O₃



Solare termico
Thermal solar



Olio / gasolio
Oil / diesel fuel

inoxPRES® O-ring FKM

Verde | Green | Grün | Vert | Verde

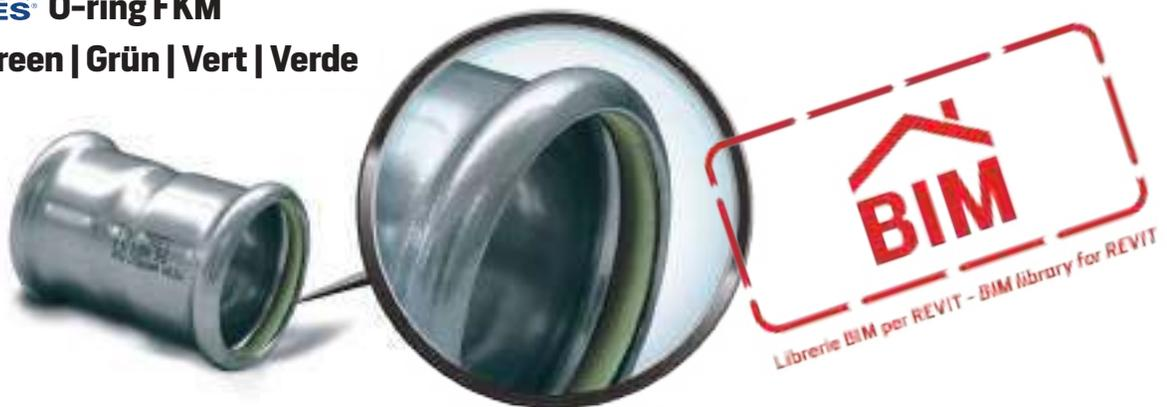

Applicazioni industriali

- Aria compressa
- Ossigeno industriale O₂ (no alimentare/ospedaliero)
- Ozono O₃
- Solare termico P max 6 bar; T max 220°C
- Olio / Gasolio

Utilizzare solo tubazioni "ricotte". Eventuali altre veicolazioni di fluidi particolari, devono essere valutate dall'ufficio tecnico di RM.

O-ring FKM verde

Industrial applications

- Compressed air
- Industrial Oxygen O₂ (no food/hospital)
- Ozone O₃
- Thermal solar P max 6 bar; T max 220°C
- Oil/diesel fuel

Only "annealed" pipes can be used. Any other vehiculation of special fluids, must be evaluated from RM technical office.

Green FKM O-Ring

FOCUS ON **SILICONE
FREE**

IT

I componenti del sistema Inoxpres HT risultano sgrassati:

- in classe E sulla base del livello dei residui di sostanze volatili misurati in accordo allo standard ASTM F331-05;
- in classe D sulla base del livello dei residui di sostanze volatili misurati in accordo allo standard ASTM G 144-01;

[test report JOB ID 147 del 09/03/2017]

Gli o-ring FKM del sistema di raccordi a pressare:

- sono stati testati con Spettrofotometria ad infrarosso (FT-IR): non si è rilevata presenza di silicone [test report RA160100 del 15/04/2016]

EN

The components of Inoxpres HT system are degreased:

- Class E on the basis of the level of residues of volatile substances measured in accordance with ASTM F331-05 standards;
- Class D on the basis of the volatile residues level measured in accordance with ASTM G 144-01 standards;

[Test reports JOB ID 147 - 09.03.2017]

The FKM O-rings of press fitting system:

- are tested with infrared spectrophotometry (FT-IR): It has not detected the presence of silicon [Test report RA160100 - 15.04.2016]

DE

Die Komponenten des Inoxpres HT Systems sind entfettet:

- Klasse E auf der Grundlage des Rückstands an flüchtigen Stoffen, gemessen nach ASTM F331-05-Standard;
- Klasse D auf der Basis des flüchtigen Rückstandsniveaus, gemessen nach ASTM G 144-01 Standard;

[Prüfberichte JOB ID 147 - 09.03.2017]

Die FKM O-Ringe für Pressfitting:

- werden mit Infrarotspektrophotometrie (FT-IR) getestet: Es wurde das Vorhandensein von Silikon nicht nachgewiesen [Prüfbericht RA160100 - 15.04.2016]

FR

Les composants du système Inoxpres HT sont dégraissés:

- Classe E sur la base du niveau des résidus de substances volatiles mesuré selon la norme ASTM F331-05;
- Classe D sur la base du niveau des résidus de substances volatiles mesuré selon la norme ASTM G 144-01;

[Rapports d'essai JOB ID 147 - 09/03/2017]

Les joints FKM des systèmes de raccords à sertir:

- sont testés avec spectrophotométrie infrarouge (FT-IR): Il n'a pas détecté la présence de silicone [Rapports d'essai RA160100 - 15.04.2016]

ES

Los componentes del sistema HT Inoxpres están desengrasados según:

- Clase E: La medida del nivel de residuos de sustancias volátiles conforme a la norma ASTM F331-05;
- Clase D: La medida del nivel de residuos de sustancias volátiles conforme a la norma ASTM G 144-01;

[Informes de prueba N.º de trabajo 147, 09/03/2017]

Las juntas tóricas FKM del sistema prensado:

- Se han comprobado con una espectrofotometría infrarroja (FT-IR): No se ha detectado la presencia de silicona.

[Informes de prueba RA160100 de 15.04.2016]

Gamma dimensionale / Product range

∅ 15 ÷ 54 mm

A richiesta / On demand

∅ 76,1 ÷ 108 mm

Altre figure possono essere fornite "a richiesta"
 Other figures can be provided "on demand"
 Andere Bilder kann "auf Anfrage" vorgesehen sein
 D'autres figures peuvent être fournis "sur demande"
 Otras figuras pueden ser proporcionadas "bajo demanda"



116/300 6 m

B 30 31

TUBO PER IMPIANTI "SILICONE FREE"

- PIPE FOR "SILICONE FREE" INSTALLATION
- ROHR FÜR "SILIKONFREIE" INSTALLATION
- TUBE POUR INSTALLATION "SANS SILICONE"
- TUBO PARA INSTALACIÓN "LIBRE DE SILICONA"

NORM: EN 10217-7 (DIN 17455) - EN 10312

Mat. Nr.: 1.4404 (AISI 316L) L=6 m

Ricotto - Annealed - Geglüht - Hypertrempé - Recocido

CODE	Dimensions mm x mm	∅ int mm	L m	 kg/m	Volume l/m	Minimum package m	Bundle m	€/m
116015300	15 x 1,0	13	6	0,351	0,133	60	1014	-
116018300	18 x 1,0	16	6	0,426	0,201	60	1014	-
116022300	22 x 1,2	19,6	6	0,625	0,302	60	762	-
116028300	28 x 1,2	25,6	6	0,805	0,514	30	546	-
116035300	35 x 1,5	32	6	1,258	0,804	30	546	-
116042300	42 x 1,5	39	6	1,521	1,194	30	366	-
116054300	54 x 1,5	51	6	1,972	2,042	30	366	-

Per sistema silicone free, utilizzare solo tubo Inoxpres ricotto.

For silicone free system, only the annealed Inoxpres pipes must be used.

Für System freies Silikon, nur geglüht Inoxpres Rohre verwendet werden müssen.

Pour le système exempt de silicone, seuls les tuyaux hypertrempé Inoxpres doivent être utilisés.

Para el sistema libre de silicona, se deben utilizar únicamente tuberías recocida Inoxpres.

B1016

**181/450 HT****CURVA 45° FF**

- 45° ELBOW FF
- BOGEN 45° II
- COUDE FF 45°
- CURVA 45° HH

MATERIAL: AISI 316L – 1.4404**O-RING:** FKM verde - green - Grün - vert - verde**TYPE:** esente silicone - silicon free
Siliconfrei - sans silicone
libre de silica

CODE	De mm	Radius	L mm	Z mm	g	€
181015450HT	15	1,5 De	36	16	50	-
181018450HT	18	1,5 De	37	17	64	-
181022450HT	22	1,5 De	41	20	82	-
181028450HT	28	1,5 De	47	24	112	-
181035450HT	35	1,2 De	43	17	127	-
181042450HT	42	1,2 De	51	21	177	-
181054450HT	54	1,2 De	62	30	273	-

B1016

**181/450C HT****CURVA 45° FF - RAGGIO STRETTO**

- 45° ELBOW FF - SHORT RADIUS
- BOGEN 45° II - KURZER RADIUS
- COUDE FF 45° - RAYON COURT
- CURVA 45° HH - RADIO CORTO

MATERIAL: AISI 316L – 1.4404**O-RING:** FKM verde - green - Grün - vert - verde**TYPE:** esente silicone - silicon free
Siliconfrei - sans silicone
libre de silica

CODE	De mm	Radius	L mm	Z mm	g	€
181015450CHT	15	1,2 De	27,5	7,5	39	-
181018450CHT	18	1,2 De	29,5	9,5	48	-
181022450CHT	22	1,2 De	32	11	63	-
181028450CHT	28	1,2 De	37	14	90	-

B 10 16

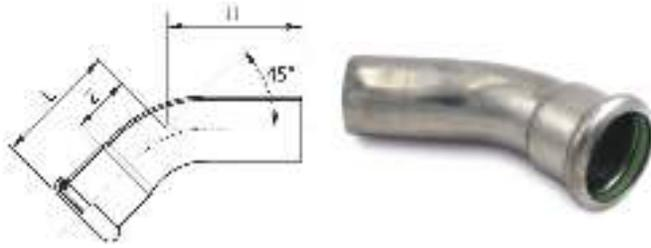

181/451 HT

CURVA 45° MF

- 45° ELBOW MF
- BOGEN 45° IA
- COUDE MF 45°
- CURVA 45° HM

MATERIAL: AISI 316L - 1.4404

O-RING: FKM verde - green - Grün - vert - verde

TYPE: esente silicone - silicon free
Siliconfrei - sans silicone
libre de silicona

CODE	De mm	Radius	L mm	H mm	Z mm	g		€
181015451HT	15	1,5 De	36	49	16	50	1	-
181018451HT	18	1,5 De	37	43	17	64	1	-
181022451HT	22	1,5 De	41	48	20	82	1	-
181028451HT	28	1,5 De	47	54,5	22	112	1	-
181035451HT	35	1,2 De	43	57,5	17	132	1	-
181042451HT	42	1,2 De	51	72	21	196	1	-
181054451HT	54	1,2 De	62	82	26	296	1	-

B 10 16

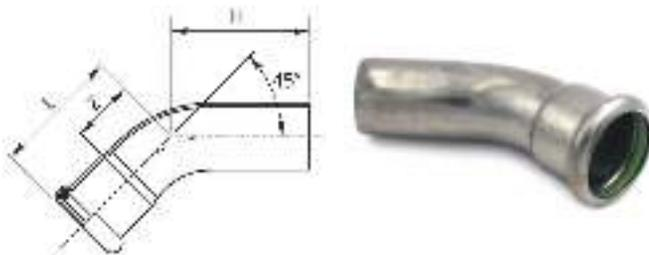

181/451C HT

CURVA 45° MF - RAGGIO STRETTO

- 45° ELBOW MF - SHORT RADIUS
- BOGEN 45° IA - KURZER RADIUS
- COUDE MF 45° - RAYON COURT
- CURVA 45° HM - RADIO CORTO

MATERIAL: AISI 316L - 1.4404

O-RING: FKM verde - green - Grün - vert - verde

TYPE: esente silicone - silicon free
Siliconfrei - sans silicone
libre de silicona

CODE	De mm	Radius	L mm	H mm	Z mm	g		€
181015451C HT	15	1,2 De	27,5	36	7,5	38	1	-
181018451C HT	18	1,2 De	29,5	38	9,5	47	1	-
181022451C HT	22	1,2 De	32	42	11	63	1	-
181028451C HT	28	1,2 De	37	46	14	90	1	-

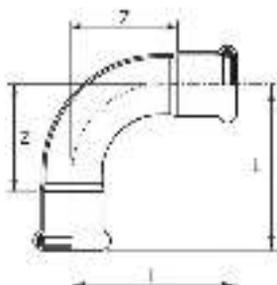
**181/900 HT****CURVA 90° FF**

- 90° ELBOW FF
- BOGEN 90° II
- COUDE FF 90°
- CURVA 90° HH

MATERIAL: AISI 316L – 1.4404**O-RING:** FKM verde - green - Grün - vert - verde**TYPE:** esente silicone - silicon free
Siliconfrei - sans silicone
libre de silica

CODE	De mm	Radius	L mm	Z mm	g	€
181015900HT	15	1,5 De	50	30	58	-
181018900HT	18	1,5 De	54	34	72	-
181022900HT	22	1,5 De	60	39	102	-
181028900HT	28	1,5 De	73	50	143	-
181035900HT	35	1,2 De	68	42	162	-
181042900HT	42	1,2 De	80	50	231	-
181054900HT	54	1,2 De	100	64	367	-

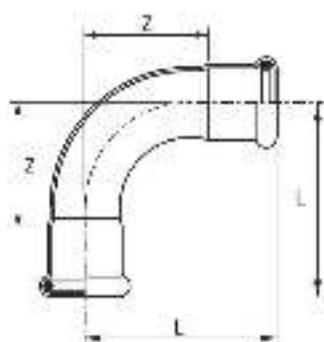
**181/900C HT****CURVA 90° FF - RAGGIO STRETTO**

- 90° ELBOW FF - SHORT RADIUS
- BOGEN 90° II - KURZER RADIUS
- COUDE FF 90° - RAYON COURT
- CURVA 90° HH - RADIO CORTO

MATERIAL: AISI 316L – 1.4404**O-RING:** FKM verde - green - Grün - vert - verde**TYPE:** esente silicone - silicon free
Siliconfrei - sans silicone
libre de silica

CODE	De mm	Radius	L mm	Z mm	g	€
181015900CHT	15	1,2 De	38	18	46	-
181018900CHT	18	1,2 De	41,5	21,5	58	-
181022900CHT	22	1,2 De	47	26	78	-
181028900CHT	28	1,2 De	56	33	116	-

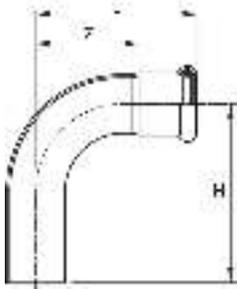

181/901 HT

B 10 16

CURVA 90° MF

- 90° ELBOW MF
- BOGEN 90° IA
- COUDE MF 90°
- CURVA 90° HM

MATERIAL: AISI 316L - 1.4404

O-RING: FKM verde - green - Grün - vert - verde

TYPE: esente silicone - silicon free
Siliconfrei - sans silicone
libre de silica

CODE	De mm	Radius	L mm	H mm	Z mm	g	€
181015901HT	15	1,5 De	50	63	30	58	1 -
181018901HT	18	1,5 De	54	63	34	72	1 -
181022901HT	22	1,5 De	60	71	39	102	1 -
181028901HT	28	1,5 De	73	81	50	143	1 -
181035901HT	35	1,2 De	68	82	42	176	1 -
181042901HT	42	1,2 De	80	101	50	253	1 -
181054901HT	54	1,2 De	100	120	64	390	1 -



181/901C HT

B 10 16

IT:CURVA 90° MF - RAGGIO STRETTO

- 90° ELBOW MF - SHORT RADIUS
- BOGEN 90° IA - KURZER RADIUS
- COUDE MF 90° - RAYON COURT
- CURVA 90° HM - RADIO CORTO

MATERIAL: AISI 316L - 1.4404

O-RING: FKM verde - green - Grün - vert - verde

TYPE: esente silicone - silicon free
Siliconfrei - sans silicone
libre de silica

CODE	De mm	Radius	L mm	H mm	Z mm	g	€
181015901C HT	15	1,2 De	38	48	18	46	1 -
181018901C HT	18	1,2 De	41,5	48,5	21,5	56	1 -
181022901C HT	22	1,2 De	47	57	26	79	1 -
181028901C HT	28	1,2 De	56	64	33	115	1 -

B1016

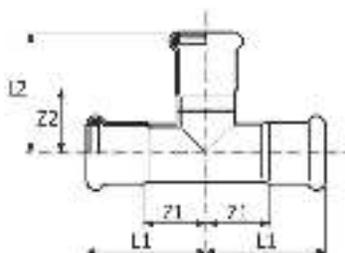
**182 HT****"T"**

- EQUAL TEE
- T-STÜCK
- TÉ ÉGAL
- TE IGUAL HHH

MATERIAL: AISI 316L – 1.4404**O-RING:** FKM verde - green - Grün - vert - verde**TYPE:** esente silicone - silicon free
Siliconfrei - sans silicone
libre de silica

CODE	De mm	L1 mm	L2 mm	Z1 mm	Z2 mm	g	€
182015000HT	15	34	39	14	19	67	1 -
182018000HT	18	37	41	16	21	80	1 -
182022000HT	22	39	45	18	24	106	1 -
182028000HT	28	44	50	21	27	145	1 -
182035000HT	35	51	57	25	31	201	1 -
182042000HT	42	59	65	28	35	260	1 -
182054000HT	54	70	77	34	42	404	1 -

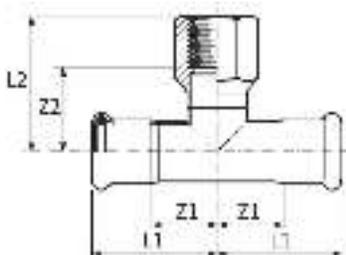
**189 HT****"T" CON DERIVAZIONE FILETTO F**

- BRANCH TEE FEMALE BSP OUTLET
- T-STÜCK MIT ABGANG IG
- TÉ MIXTE AVEC FILETAGE F
- TE HEMBRA ROSCADA

MATERIAL: AISI 316L – 1.4404**O-RING:** FKM verde - green - Grün - vert - verde**TYPE:** esente silicone - silicon free
Siliconfrei - sans silicone
libre de silica**THREAD:** EN 10226-1 (ex ISO 7/1)

CODE	De x Rp x De mm x inch x mm	L1 mm	L2 mm	Z1 mm	Z2 mm	g	€
189102015HT*	15 x 1/2" x 15	36,5	22,5	16,5	8,5	117	1 -
189102018HT*	18 x 1/2" x 18	36	24	16	10	128	1 -
189102022HT*	22 x 1/2" x 22	39	26	18	12	159	1 -
189304022HT*	22 x 3/4" x 22	41,5	30	20,5	14	184	1 -
189102028HT*	28 x 1/2" x 28	44	29	21	15	217	1 -
189304028HT*	28 x 3/4" x 28	44	30	21	14	221	1 -
189100035HT	35 x 1" x 35	51	47	22	28	250	1 -
189100042HT	42 x 1" x 42	59	60	29	41	346	1 -
189102054HT	54 x 1/2" x 54	70	61	34	46	337	1 -
189304054HT	54 x 3/4" x 54	70	64	34	48	391	1 -
189200054HT	54 x 2" x 54	70	81	34	55	838	1 -

[*] senza saldatura - seamless - nahtlos - sans soudure - sin soldadura

B 10 16

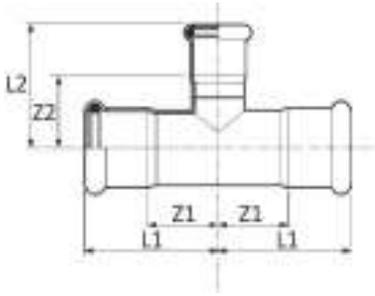

192 HT

“T” RIDOTTO

- REDUCING TEE
- T-STÜCK MIT REDUZIERTEM ABGANG
- TÉ RÉDUIT
- TE REDUCIDA HHH

MATERIAL: AISI 316L - 1.4404

O-RING: FKM verde - green - Grün - vert - verde

TYPE: esente silicone - silicon free
Siliconfrei - sans silicone
libre de silicona

CODE	De mm	L1 mm	L2 mm	Z1 mm	Z2 mm	g	€
192018015HT	18 x 15 x 18	36,5	41	15,5	21	80	-
192022018HT	22 x 18 x 22	39	44	18	23	98	-
192028022HT	28 x 22 x 28	44	47	21	26	135	-
192035022HT	35 x 22 x 35	51	51	25	30	167	-
192035028HT	35 x 28 x 35	51	54	25	31	171	-
192042028HT	42 x 28 x 42	59	57	29	34	243	-
192042035HT	42 x 35 x 42	59	61	29	35	272	-
192054035HT	54 x 35 x 54	70	68	34	42	361	-
192054042HT	54 x 42 x 54	70	72	34	42	376	-

B 10 16

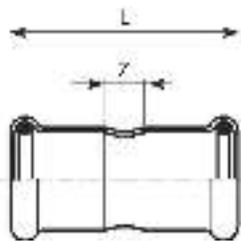

183/000 HT

MANICOTTO

- COUPLING
- MUFFE
- MANCHON
- MANGUITO HH

MATERIAL: AISI 316L - 1.4404

O-RING: FKM verde - green - Grün - vert - verde

TYPE: esente silicone - silicon free
Siliconfrei - sans silicone
libre de silicona

CODE	De mm	L mm	Z mm	g	€
183015000HT	15	49	9	35	-
183018000HT	18	50	10	42	-
183022000HT	22	53	11	54	-
183028000HT	28	56	10	71	-
183035000HT	35	63	10	97	-
183042000HT	42	72	12	136	-
183054000HT	54	83	13	198	-

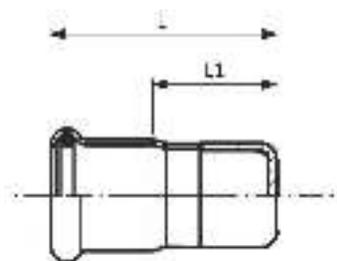
**183/003 HT****B 10 16****TAPPO DI CHIUSURA**

- STOP END
- VERSCHLUSSKAPPE
- BOUCHON D'OBTURATION
- TAPÓN

MATERIAL: AISI 316L - 1.4404**O-RING:** FKM verde - green - Grün - vert - verde**TYPE:** esente silicone - silicon free
Siliconfrei - sans silicone
libre de silicona

CODE	De mm	L mm	L1 mm	g		€
183015003HT	15	44	24	32	1	-
183018003HT	18	44	24	38	1	-
183022003HT	22	45	24	51	1	-
183028003HT	28	48	25	68	1	-
183035003HT	35	52	26	95	1	-
183042003HT	42	56	26	126	1	-
183054003HT	54	62	27	185	1	-

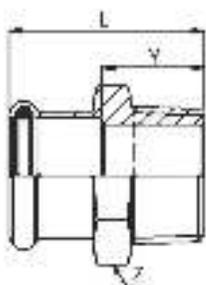
**187 HT****B 10 16****MANICOTTO MISTO FILETTO M**

- MALE ADAPTER
- ÜBERGANGSSTÜCK MIT AG
- RACCORD AVEC FILETAGE MALE
- UNIÓN MACHO

MATERIAL: AISI 316L - 1.4404**O-RING:** FKM verde - green - Grün - vert - verde**TYPE:** esente silicone - silicon free
Siliconfrei - sans silicone
libre de silicona**THREAD:** EN 10226-1 (ex ISO 7/1)

CODE	De x R mm x inch	L mm	Z mm	Y mm	g		€
187102015HT	15 x 1/2"	41	24	21	54	1	-
187102018HT	18 x 1/2"	41	27	21	58	1	-
187102022HT	22 x 1/2"	42	32	21	83	1	-
187304022HT	22 x 3/4"	44	32	23	89	1	-
187100022HT	22 x 1"	46	36	25	154	1	-
187304028HT	28 x 3/4"	47	38	24	114	1	-
187100028HT	28 x 1"	48	38	25	123	1	-
187114035HT	35 x 1 1/4"	55	46	28	180	1	-
187112042HT	42 x 1 1/2"	59	55	28	236	1	-
187200054HT	54 x 2"	71	65	35	362	1	-

B 10 16

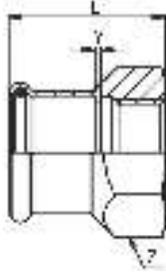

190 HT

MANICOTTO MISTO FILETTO F

- FEMALE ADAPTER
- ÜBERGANGSSTÜCK MIT IG
- RACCORD AVEC FILETAGE FEMELLE
- UNIÓN HEMBRA

MATERIAL: AISI 316L - 1.4404

O-RING: FKM verde - green - Grün - vert - verde

TYPE: esente silicone - silicon free
Siliconfrei - sans silicone
libre de silicona

THREAD: EN 10226-1 (ex ISO 7/1)

CODE	De x Rp mm x inch	L mm	Z mm	Y mm	 g		€
190102015HT	15 x 1/2"	38	27	2	64	1	-
190102018HT	18 x 1/2"	38	27	2	89	1	-
190304022HT	22 x 3/4"	40	32	2	82	1	-
190304028HT	28 x 3/4"	42	38	2	130	1	-
190100028HT	28 x 1"	45	41	2	158	1	-
190114035HT	35 x 1 1/4"	52	46	2	170	1	-
190112042HT	42 x 1 1/2"	56	55	2	243	1	-
190200054HT	54 x 2"	65	65	2	314	1	-

B 10 16

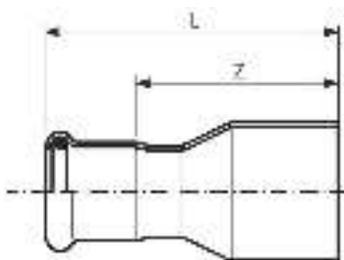

191 HT

RIDUZIONE MF

- REDUCER
- REDUZIERSTÜCK
- REDUCTION
- REDUCCIÓN MH

MATERIAL: AISI 316L - 1.4404

O-RING: FKM verde - green - Grün - vert - verde

TYPE: esente silicone - silicon free
Siliconfrei - sans silicone
libre de silicona

CODE	De mm	L mm	Z mm	 g		€
191018015HT	18 x 15	57	37	35	1	-
191022018HT	22 x 18	60	60	47	1	-
191028015HT	28 x 15	56,5	76,5	50	1	-
191028022HT	28 x 22	65	44	66	1	-
191035028HT	35 x 28	71	48	98	1	-
191042035HT	42 x 35	81	55	138	1	-
191054042HT	54 x 42	97,5	67,5	210	1	-

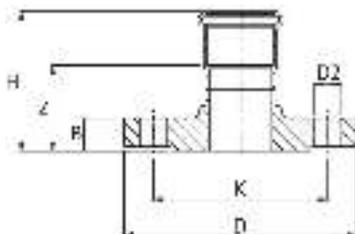
**193/000 HT****B 10 16****MANICOTTO FLANGIATO**

- ADAPTOR FLANGE
- ÜBERGANGSFLANSCH
- BRIDE DE RACCORDEMENT
- BRIDA ADAPTADOR

MATERIAL: AISI 316L - 1.4404**O-RING:** FKM verde - green - Grün - vert - verde**TYPE:** esente silicone - silicon free
Siliconfrei - sans silicone
libre de silica**PN 16**

CODE	De mm	DN flg	H mm	Z mm	B mm	D mm	D2 mm	Holes Nr.	K mm			€
193015000HT	15	15	55	35	14	95	14	4	65	660	1	-
193018000HT	18	15	55,5	35,5	14	95	14	4	65	660	1	-
193022000HT	22	20	58,5	37,5	16	105	14	4	75	945	1	-
193028000HT	28	25	61,5	38,5	16	115	14	4	85	1140	1	-
193035000HT	35	32	65,5	39,5	16	140	18	4	100	1640	1	-
193042000HT	42	40	69	39	16	150	18	4	110	1800	1	-
193054000HT	54	50	78	42	18	165	18	4	125	2450	1	-

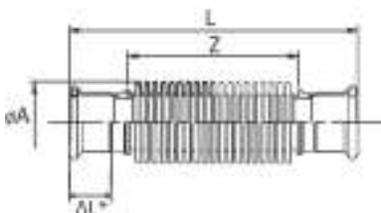
**199 HT****B 10 16****COMPENSATORE DI DILATAZIONE**

- EXPANSION COMPENSATOR
- WELLENKOMPENSATOR
- COMPENSATEUR D'EXPANSION
- DILATADOR

MATERIAL: AISI 316L - 1.4404**O-RING:** FKM verde - green - Grün - vert - verde**TYPE:** esente silicone - silicon free
Siliconfrei - sans silicone
libre de silica

CODE	De mm	L mm	ΔL* mm	Cycles**	Z mm	A mm			€
199015000HT	15	139	16	800	71	22	80	1	-
199018000HT	18	143	18	800	74	27	108	1	-
199022000HT	22	139	20	800	68	34	130	1	-
199028000HT	28	150	22	800	73	41	155	1	-
199035000HT	35	177	26	800	90	51	251	1	-
199042000HT	42	202	32	800	107	61	440	1	-
199054000HT	54	221	36	800	113	71	550	1	-

[*] Corsa assiale in compressione - Compression axial stroke - Axialhub in Kompression - Course axiale en compression - Carrera axial en compresión

[**] Numero di cicli di lavoro alla massima compressione - Work cycles number at maximum compression - Anzahl der Zyklen bei einer maximaler Kompression - Nombre de cycles de travail à compression maximale - Número de ciclos de trabajo a máxima compresión

Campi di applicazione / Fields of application

inoxPRES® STEAM



Vapore saturo
Saturated steam
Max 7 bar / 165°C

inoxPRES® O-ring STEAM

Bianco | White | Weiß | Blanc | Blanco

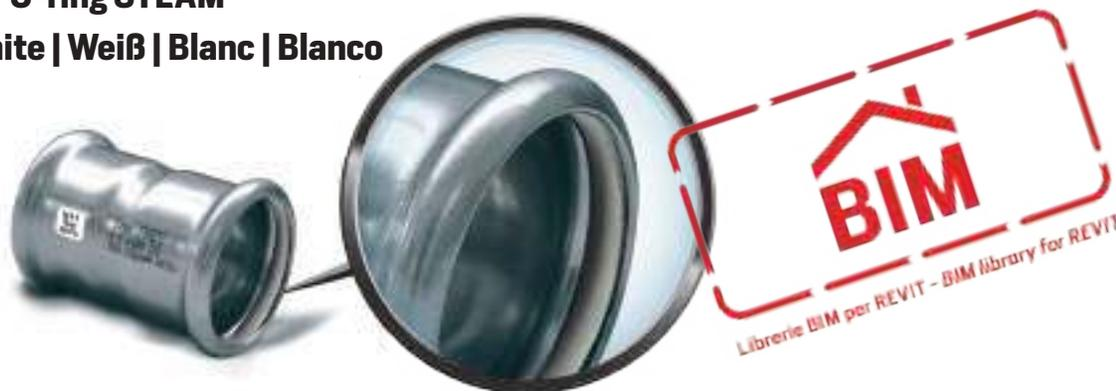

Applicazioni industriali O-Ring STEAM bianco

➤ Vapore saturo **P max 7 bar assoluti (6 bar relativi);**
T max 165°C

Eventuali altre veicolazioni di fluidi particolari, devono essere valutate dall'ufficio tecnico di RM.

Industrial applications White STEAM O - ring

➤ Saturated steam **7 bar absolute (6 bar relative);**
T max 165°

Any other vehiculation of specialfluids, must be evaluated from RM technical office.

Gamma dimensionale / Product range

ø 15 ÷ 54 mm

A richiesta / On demand

ø 76,1 ÷ 108 mm

Altre figure possono essere fornite "a richiesta"
Other figures can be provided "on demand"
Andere Bilder kann "auf Anfrage" vorgesehen sein
D'autres figures peuvent être fournis "sur demande"
Otras figuras pueden ser proporcionadas "bajo demanda"

**116/200 6 m****B 30 31****TUBO PER VAPORE SATURO**

- PIPE FOR SATURATED STEAM
- ROHR FÜR SATTDAMPF
- TUBE POUR VAPEUR SATURÉE
- TUBO PARA VAPOR SATURADO

NORM: EN 10217-7 (DIN 17455) - EN 10312**Mat. Nr.: 1.4404 (AISI 316L) L=6 m****Crudo - Not annealed - Ungeglüht - Non-hypertrempé - Crudo**

CODE	Dimensions mm x mm	Ø int mm	L m	 kg/m	Volume l/m	Minimum package m	Bundle m	€/m
116015200	15 x 1,0	13	6	0,351	0,133	60	1014	-
116018200	18 x 1,0	16	6	0,426	0,201	60	1014	-
116022200	22 x 1,2	19,6	6	0,625	0,302	60	762	-
116028200	28 x 1,2	25,6	6	0,805	0,514	30	546	-
116035200	35 x 1,5	32	6	1,258	0,804	30	546	-
116042200	42 x 1,5	39	6	1,521	1,194	30	366	-
116054200	54 x 1,5	51	6	1,972	2,042	30	366	-

**116/300 6 m****B 30 31****TUBO PER VAPORE SATURO**

- PIPE FOR SATURATED STEAM
- ROHR FÜR SATTDAMPF
- TUBE POUR VAPEUR SATURÉE
- TUBO PARA VAPOR SATURADO

NORM: EN 10217-7 (DIN 17455) - EN 10312**Mat. Nr.: 1.4404 (AISI 316L) L=6 m****Ricotto - Annealed - Geglüht - Hypertrempé - Recocido**

CODE	Dimensions mm x mm	Ø int mm	L m	 kg/m	Volume l/m	Minimum package m	Bundle m	€/m
116015300	15 x 1,0	13	6	0,351	0,133	60	1014	-
116018300	18 x 1,0	16	6	0,426	0,201	60	1014	-
116022300	22 x 1,2	19,6	6	0,625	0,302	60	762	-
116028300	28 x 1,2	25,6	6	0,805	0,514	30	546	-
116035300	35 x 1,5	32	6	1,258	0,804	30	546	-
116042300	42 x 1,5	39	6	1,521	1,194	30	366	-
116054300	54 x 1,5	51	6	1,972	2,042	30	366	-

**114/200 6 m****B 30 34****TUBO PER VAPORE SATURO**

- PIPE FOR SATURATED STEAM
- ROHR FÜR SATTDAMPF
- TUBE POUR VAPEUR SATURÉE
- TUBO PARA VAPOR SATURADO

NORM: EN 10217-7 (DIN 17455) - EN 10312**Mat. Nr.: 1.4301 (AISI 304) L=6 m****Crudo - Not annealed - Ungeglüht - Non-hypertrempé - Crudo**

CODE	Dimensions mm x mm	Ø int mm	L m	 kg/m	Volume l/m	Minimum package m	Bundle m	€/m
114015200	15 x 1,0	13	6	0,351	0,133	60	1014	-
114018200	18 x 1,0	16	6	0,426	0,201	60	1014	-
114022200	22 x 1,2	19,6	6	0,625	0,302	60	762	-
114028200	28 x 1,2	25,6	6	0,805	0,514	30	546	-
114035200	35 x 1,5	32	6	1,258	0,804	30	546	-
114042200	42 x 1,5	39	6	1,521	1,194	30	366	-
114054200	54 x 1,5	51	6	1,972	2,042	30	366	-

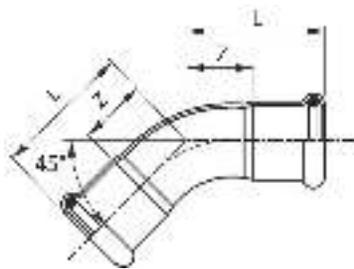
**181/450 ST****CURVA 45° FF**

- 45° ELBOW FF
- BOGEN 45° II
- COUDE FF 45°
- CURVA 45° HH

MATERIAL: AISI 316L – 1.4404**O-RING:** STEAM bianco - white - Weiß
blanc - blanco**TYPE:** vapore saturo - saturated steam
Satttdampf - vapeur saturée
vapor saturado
P max 7 bara [6 barg] - T max 165°C

CODE	De mm	Radius	L mm	Z mm	 g		€
181015450ST	15	1,5 De	36	16	50	1	-
181018450ST	18	1,5 De	37	17	64	1	-
181022450ST	22	1,5 De	41	20	82	1	-
181028450ST	28	1,5 De	47	24	112	1	-
181035450ST	35	1,2 De	43	17	127	1	-
181042450ST	42	1,2 De	51	21	177	1	-
181054450ST	54	1,2 De	62	30	273	1	-

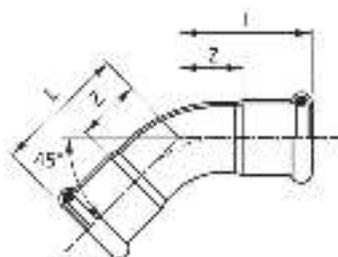
**181/450C ST****CURVA 45° FF - RAGGIO STRETTO**

- 45° ELBOW FF - SHORT RADIUS
- BOGEN 45° II - KURZER RADIUS
- COUDE FF 45° - RAYON COURT
- CURVA 45° HH - RADIO CORTO

MATERIAL: AISI 316L – 1.4404**O-RING:** STEAM bianco - white - Weiß
blanc - blanco**TYPE:** vapore saturo - saturated steam
Satttdampf - vapeur saturée
vapor saturado
P max 7 bara [6 barg] - T max 165°C

CODE	De mm	Radius	L mm	Z mm	 g		€
181015450CST	15	1,2 De	27,5	7,5	39	1	-
181018450CST	18	1,2 De	29,5	9,5	48	1	-
181022450CST	22	1,2 De	32	11	63	1	-
181028450CST	28	1,2 De	37	14	90	1	-

B 10 15

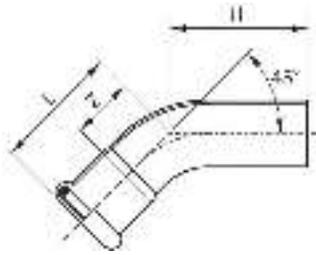

181/451 ST

CURVA 45° MF

- 45° ELBOW MF
- BOGEN 45° IA
- COUDE MF 45°
- CURVA 45° HM

MATERIAL: AISI 316L - 1.4404

O-RING: STEAM bianco - white - Weiß
blanc - blanco

TYPE: vapore saturo - saturated steam
Sattdampf - vapeur saturée
vapor saturado
P max 7 bara [6 barg] - T max 165°C

CODE	De mm	Radius	L mm	H mm	Z mm	g	€
181015451ST	15	1,5 De	36	49	16	50	1 -
181018451ST	18	1,5 De	37	43	17	64	1 -
181022451ST	22	1,5 De	41	48	20	82	1 -
181028451ST	28	1,5 De	47	54,5	22	112	1 -
181035451ST	35	1,2 De	43	57,5	17	132	1 -
181042451ST	42	1,2 De	51	72	21	196	1 -
181054451ST	54	1,2 De	62	82	26	296	1 -

B 10 15

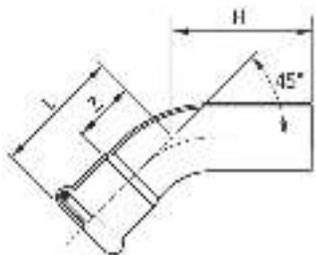

181/451C ST

CURVA 45° MF - RAGGIO STRETTO

- 45° ELBOW MF - SHORT RADIUS
- BOGEN 45° IA - KURZER RADIUS
- COUDE MF 45° - RAYON COURT
- CURVA 45° HM - RADIO CORTO

MATERIAL: AISI 316L - 1.4404

O-RING: STEAM bianco - white - Weiß
blanc - blanco

TYPE: vapore saturo - saturated steam
Sattdampf - vapeur saturée
vapor saturado
P max 7 bara [6 barg] - T max 165°C

CODE	De mm	Radius	L mm	H mm	Z mm	g	€
181015451CST	15	1,2 De	27,5	36	7,5	38	1 -
181018451CST	18	1,2 De	29,5	38	9,5	47	1 -
181022451CST	22	1,2 De	32	42	11	63	1 -
181028451CST	28	1,2 De	37	46	14	90	1 -

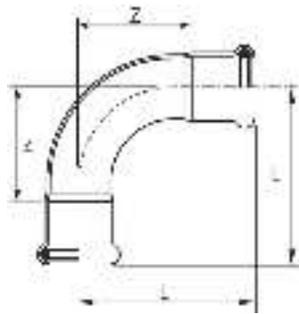
**181/900 ST****B 10 15****CURVA 90° FF**

- 90° ELBOW FF
- BOGEN 90° II
- COUDE FF 90°
- CURVA 90° HH

MATERIAL: AISI 316L – 1.4404**O-RING:** STEAM bianco - white - Weiß
blanc - blanco**TYPE:** vapore saturo - saturated steam
Satttdampf - vapeur saturée
vapor saturado
P max 7 bara [6 barg] - T max 165°C

CODE	De mm	Radius	L mm	Z mm	 g		€
181015900ST	15	1,5 De	50	30	58	1	-
181018900ST	18	1,5 De	54	34	72	1	-
181022900ST	22	1,5 De	60	39	102	1	-
181028900ST	28	1,5 De	73	50	143	1	-
181035900ST	35	1,2 De	68	42	162	1	-
181042900ST	42	1,2 De	80	50	231	1	-
181054900ST	54	1,2 De	100	64	367	1	-

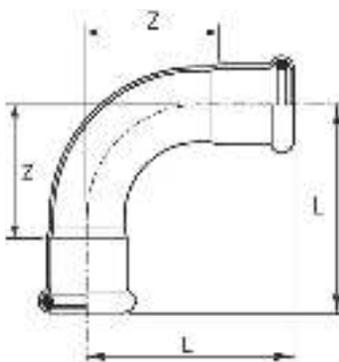
**181/900C ST****B 10 15****CURVA 90° FF - RAGGIO STRETTO**

- 90° ELBOW FF - SHORT RADIUS
- BOGEN 90° II - KURZER RADIUS
- COUDE FF 90° - RAYON COURT
- CURVA 90° HH - RADIO CORTO

MATERIAL: AISI 316L – 1.4404**O-RING:** STEAM bianco - white - Weiß
blanc - blanco**TYPE:** vapore saturo - saturated steam
Satttdampf - vapeur saturée
vapor saturado
P max 7 bara [6 barg] - T max 165°C

CODE	De mm	Radius	L mm	Z mm	 g		€
181015900CST	15	1,2 De	38	18	46	1	-
181018900CST	18	1,2 De	41,5	21,5	58	1	-
181022900CST	22	1,2 De	47	26	78	1	-
181028900CST	28	1,2 De	56	33	116	1	-

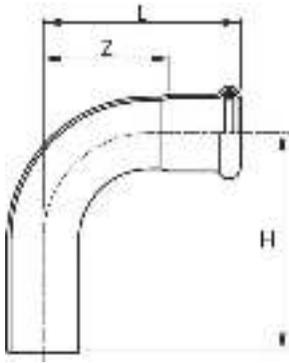

181/901 ST

B 10 15

CURVA 90° MF

- 90° ELBOW MF
- BOGEN 90° IA
- COUDE MF 90°
- CURVA 90° HM

MATERIAL: AISI 316L - 1.4404

O-RING: STEAM bianco - white - Weiß
blanc - blanco

TYPE: vapore saturo - saturated steam
Sattdampf - vapeur saturée
vapor saturado
P max 7 bara [6 barg] - T max 165°C

CODE	De mm	Radius	L mm	H mm	Z mm			€
181015901ST	15	1,5 De	50	63	30	58	1	-
181018901ST	18	1,5 De	54	63	34	72	1	-
181022901ST	22	1,5 De	60	71	39	102	1	-
181028901ST	28	1,5 De	73	81	50	143	1	-
181035901ST	35	1,2 De	68	82	42	176	1	-
181042901ST	42	1,2 De	80	101	50	253	1	-
181054901ST	54	1,2 De	100	120	64	390	1	-

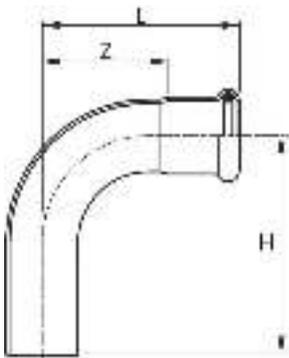

181/901C ST

B 10 15

IT:CURVA 90° MF - RAGGIO STRETTO

- 90° ELBOW MF - SHORT RADIUS
- BOGEN 90° IA - KURZER RADIUS
- COUDE MF 90° - RAYON COURT
- CURVA 90° HM - RADIO CORTO

MATERIAL: AISI 316L - 1.4404

O-RING: STEAM bianco - white - Weiß
blanc - blanco

TYPE: vapore saturo - saturated steam
Sattdampf - vapeur saturée
vapor saturado
P max 7 bara [6 barg] - T max 165°C

CODE	De mm	Radius	L mm	H mm	Z mm			€
181015901CST	15	1,2 De	38	48	18	46	1	-
181018901CST	18	1,2 De	41,5	48,5	21,5	56	1	-
181022901CST	22	1,2 De	47	57	26	79	1	-
181028901CST	28	1,2 De	56	64	33	115	1	-

B1015

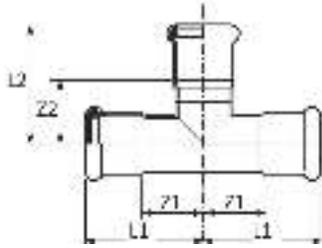
**182 ST****“T”**

- EQUAL TEE
- T-STÜCK
- TÉ ÉGAL
- TE IGUAL HHH

MATERIAL: AISI 316L – 1.4404**O-RING:** STEAM bianco - white - Weiß
blanc - blanco**TYPE:** vapore saturo - saturated steam
Satttdampf - vapeur saturée
vapor saturado
P max 7 bara [6 barg] - T max 165°C

CODE	De mm	Z1 mm	Z2 mm	L1 mm	L2 mm	g	€
182015000ST	15	14	19	34	39	67	1
182018000ST	18	16	21	37	41	80	1
182022000ST	22	18	24	39	45	106	1
182028000ST	28	21	27	44	50	145	1
182035000ST	35	25	31	51	57	201	1
182042000ST	42	28	35	59	65	260	1
182054000ST	54	34	42	70	77	404	1

B1015

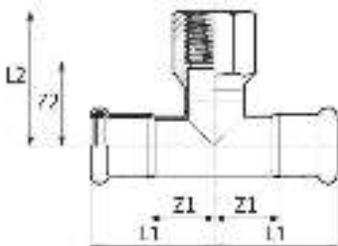
**189 ST****“T” CON DERIVAZIONE FILETTO F**

- BRANCH TEE FEMALE BSP OUTLET
- T-STÜCK MIT ABGANG IG
- TÉ MIXTE AVEC FILETAGE F
- TE HEMBRA ROSCADA

MATERIAL: AISI 316L – 1.4404**O-RING:** STEAM bianco - white - Weiß
blanc - blanco**TYPE:** vapore saturo - saturated steam
Satttdampf - vapeur saturée
vapor saturado**THREAD:** P max 7 bara [6 barg] - T max 165°C
EN 10226-1 (ex ISO 7/1)

CODE	De x Rp x De mm x inch x mm	L1 mm	L2 mm	Z1 mm	Z2 mm	g	€
189102015ST*	15 x 1/2" x 15	36,5	22,5	16,5	8,5	117	1
189102018ST*	18 x 1/2" x 18	36	24	16	10	128	1
189102022ST*	22 x 1/2" x 22	39	26	18	12	159	1
189304022ST*	22 x 3/4" x 22	41,5	30	20,5	14	184	1
189102028ST*	28 x 1/2" x 28	44	29	21	15	217	1
189304028ST*	28 x 3/4" x 28	44	30	21	14	221	1
189100035ST	35 x 1" x 35	51	47	22	28	250	1
189100042ST	42 x 1" x 42	59	60	29	41	346	1
189200054ST	54 x 2" x 54	70	81	34	55	838	1

[*] senza saldatura - seamless - nahtlos - sans soudure - sin soldadura

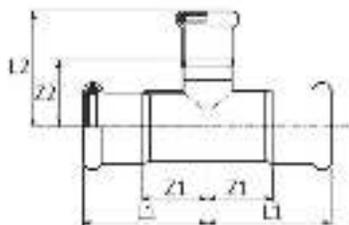
B 10 15

192 ST

“T” RIDOTTO

- REDUCING TEE
- T-STÜCK MIT REDUZIERTEM ABGANG
- TÉ RÉDUIT
- TE REDUCIDA HHH

MATERIAL: AISI 316L – 1.4404

O-RING: STEAM bianco - white - Weiß
blanc - blanco

TYPE: vapore saturo - saturated steam
Sattdampf - vapeur saturée
vapor saturado
P max 7 bara [6 barg] - T max 165°C

CODE	De mm	L1 mm	L2 mm	Z1 mm	Z2 mm	g	kg	€
192018015ST	18 x 15 x 18	36,5	41	15,5	21	80	1	-
192022018ST	22 x 18 x 22	39	43	18	23	95	1	-
192028022ST	28 x 22 x 28	44	47	21	26	135	1	-
192035022ST	35 x 22 x 35	51	51	25	30	167	1	-
192035028ST	35 x 28 x 35	51	54	25	31	171	1	-
192042028ST	42 x 28 x 42	59	57	29	34	243	1	-
192042035ST	42 x 35 x 42	59	61	29	35	272	1	-
192054035ST	54 x 35 x 54	70	68	34	42	361	1	-
192054042ST	54 x 42 x 54	70	72	34	42	376	1	-

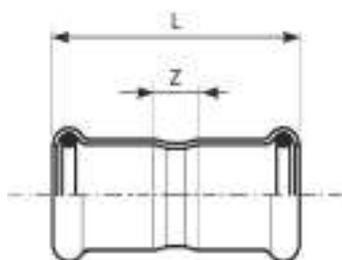
B 10 15

183/000 ST

MANICOTTO

- COUPLING
- MUFFE
- MANCHON
- MANGUITO HH

MATERIAL: AISI 316L – 1.4404

O-RING: STEAM bianco - white - Weiß
blanc - blanco

TYPE: vapore saturo - saturated steam
Sattdampf - vapeur saturée
vapor saturado
P max 7 bara [6 barg] - T max 165°C

CODE	De mm	L mm	Z mm	g	kg	€
183015000ST	15	49	9	35	1	-
183018000ST	18	50	10	42	1	-
183022000ST	22	53	11	54	1	-
183028000ST	28	56	10	71	1	-
183035000ST	35	63	10	97	1	-
183042000ST	42	72	12	136	1	-
183054000ST	54	83	13	198	1	-

B 10 15

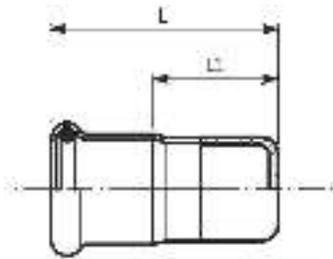
**183/003 ST****TAPPO DI CHIUSURA**

- STOP END
- VERSCHLUSSKAPPE
- BOUCHON D'OBTURATION
- TAPÓN

MATERIAL: AISI 316L - 1.4404**O-RING:** STEAM bianco - white - Weiß
blanc - blanco**TYPE:** vapore saturo - saturated steam
Satttdampf - vapeur saturée
vapor saturado
P max 7 bara (6 barg) - T max 165°C

CODE	De mm	L mm	L1 mm			€
183015003ST	15	44	24	32	1	-
183018003ST	18	44	24	38	1	-
183022003ST	22	45	24	51	1	-
183028003ST	28	48	25	68	1	-
183035003ST	35	52	26	95	1	-
183042003ST	42	56	26	126	1	-
183054003ST	54	62	27	185	1	-

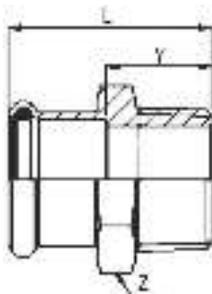
**187 ST****MANICOTTO MISTO FILETTO M**

- MALE ADAPTER
- ÜBERGANGSSTÜCK MIT AG
- RACCORD AVEC FILETAGE MALE
- UNIÓN MACHO

MATERIAL: AISI 316L - 1.4404**O-RING:** STEAM bianco - white - Weiß
blanc - blanco**TYPE:** vapore saturo - saturated steam
Satttdampf - vapeur saturée
vapor saturado**THREAD:** P max 7 bara (6 barg) - T max 165°C
EN 10226-1 (ex ISO 7/1)

CODE	De x R mm x inch	L mm	Z mm	Y mm			€
187102015ST	15 x 1/2"	41	24	21	54	1	-
187102018ST	18 x 1/2"	41	27	21	58	1	-
187102022ST	22 x 1/2"	42	32	21	83	1	-
187304022ST	22 x 3/4"	44	32	23	89	1	-
187100022ST	22 x 1"	46	36	25	154	1	-
187304028ST	28 x 3/4"	47	38	24	114	1	-
187100028ST	28 x 1"	48	38	25	123	1	-
187114035ST	35 x 1 1/4"	55	46	28	180	1	-
187112042ST	42 x 1 1/2"	59	55	28	236	1	-
187200054ST	54 x 2"	71	65	35	362	1	-

B 10 15

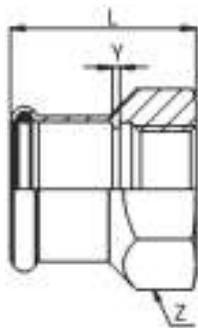
190 ST
B 10 15
MANICOTTO MISTO FILETTO F

- FEMALE ADAPTER
- ÜBERGANGSSTÜCK MIT IG
- RACCORD AVEC FILETAGE FEMELLE
- UNIÓN HEMBRA

MATERIAL: AISI 316L - 1.4404

O-RING: STEAM bianco - white - Weiß
blanc - blanco

TYPE: vapore saturo - saturated steam
Sattdampf - vapeur saturée
vapor saturado

THREAD: P max 7 bara [6 barg] - T max 165°C
EN 10226-1 (ex ISO 7/1)

CODE	De x Rp mm x inch	L mm	Z mm	Y mm	 g		€
190102015ST	15 x 1/2"	38	27	2	64	1	-
190102018ST	18 x 1/2"	38	27	2	89	1	-
190304022ST	22 x 3/4"	40	32	2	82	1	-
190304028ST	28 x 3/4"	42	38	2	130	1	-
190100028ST	28 x 1"	45	41	2	158	1	-
190114035ST	35 x 1 1/4"	52	46	2	170	1	-
190112042ST	42 x 1 1/2"	56	55	2	243	1	-
190200054ST	54 x 2"	65	65	2	314	1	-

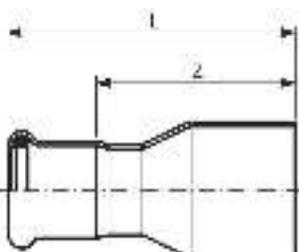
191 ST
B 10 15
RIDUZIONE MF

- REDUCER
- REDUZIERSTÜCK
- REDUCTION
- REDUCCIÓN MH

MATERIAL: AISI 316L - 1.4404

O-RING: STEAM bianco - white - Weiß
blanc - blanco

TYPE: vapore saturo - saturated steam
Sattdampf - vapeur saturée
vapor saturado

P max 7 bara [6 barg] - T max 165°C

CODE	De mm	L mm	Z mm	 g		€
191018015ST	18 x 15	57	37	35	1	-
191022018ST	22 x 18	60	40	47	1	-
191028022ST	28 x 22	65	44	66	1	-
191035028ST	35 x 28	71	48	98	1	-
191042028ST	42 x 28	93	70	130	1	-
191042035ST	42 x 35	81	55	138	1	-
191054042ST	54 x 42	97,5	67,5	210	1	-

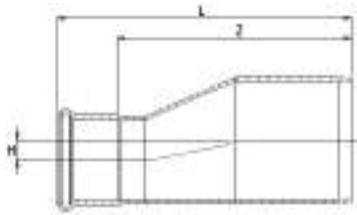
**191/E ST****B 10 15****RIDUZIONE ECCENTRICA**

- ECCENTRIC REDUCER
- REDUZIERSTÜCK EXZENTRISCH
- RÉDUCTION EXCENTRIQUE
- REDUCCIÓN EXCÉNTRICA

MATERIAL: AISI 316L – 1.4404**O-RING:** STEAM bianco - white - Weiß
blanc - blanco**TYPE:** vapore saturo - saturated steam
Satttdampf - vapeur saturée
vapor saturado
P max 7 bara [6 barg] - T max 165°C

CODE	De mm	L mm	Z mm	H mm			€
191042028EST	42 x 28	101,5	78,5	6	140	1	-
191054028EST	54 x 28	123,5	100,5	12	206	1	-
191054035EST	54 x 35	127	101,5	8,5	224	1	-

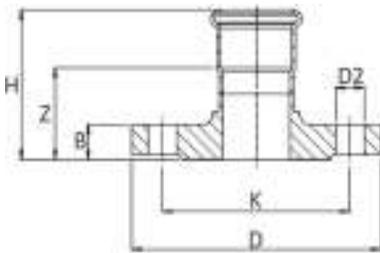
**193/000 ST****B 10 15****MANICOTTO FLANGIATO**

- ADAPTOR FLANGE
- ÜBERGANGSFLANSCH
- BRIDE DE RACCORDEMENT
- BRIDA ADAPTADOR

MATERIAL: AISI 316L – 1.4404**O-RING:** STEAM bianco - white - Weiß
blanc - blanco**TYPE:** vapore saturo - saturated steam
Satttdampf - vapeur saturée
vapor saturado
P max 7 bara [6 barg] - T max 165°C**PN 16**

CODE	De mm	DN flg	H mm	Z mm	B mm	D mm	D2 mm	Holes Nr.	K mm			€
193015000ST	15	15	55	35	14	95	14	4	65	660	1	-
193018000ST	18	15	55,5	35,5	14	95	14	4	65	660	1	-
193022000ST	22	20	58,5	37,5	16	105	14	4	75	945	1	-
193028000ST	28	25	61,5	38,5	16	115	14	4	85	1140	1	-
193035000ST	35	32	65,5	39,5	16	140	18	4	100	1640	1	-
193042000ST	42	40	69	39	16	150	18	4	110	1800	1	-
193054000ST	54	50	78	42	18	165	18	4	125	2450	1	-

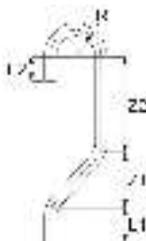
**178****B 10 11****TUBO PER DERIVAZIONE VAPORE SATURO**

- PIPE FOR SATURATED STEAM BYPASS
- ROHR FÜR SATTDAMPF-BYPASS
- TUBE POUR DÉRIVATION VAPEUR SATURÉE
- TUBO PARA DERIVACIÓN DE VAPOR SATURADO

MATERIAL: AISI 316L – 1.4404

CODE	De mm	L1 mm	L2 mm	Z1 mm	Z2 mm	R mm				€
178015316	15	30	30	96	114	35	143	1	20	-
178018316	18	50	35	108	112	39	195	1	20	-
178022316	22	50	35	110	110	41	359	1	20	-
178028316	28	60	40	139	113	51	550	1	15	-

Certificazioni / Certifications

		SYSTÈMES DE CANALISATIONS DE DISTRIBUTION D'EAU - SYSTÈME STEELPRES	79-1975-V1	Ø 15 - 108 mm
		TUBE FITTINGS - STEELPRES	TAP000017J	Ø 15 - 108 mm
		STEELPRES PRESSFITTING SYSTEM	POCC IT.AM05.H05079	Ø 15 - 108 mm
		HORGANYZOTT ACÉL CSÖVEK ÉS PRÉSIDOMOK STEELPRES PVC BEVONATOS HORGANYZOTT ACÉL CSÖVEK	A-42/2017	Ø 15 - 108 mm
		LACZNIKI ZAPRASOWYWANE ZE STALI SYSTEMU INOXPRES I STEELPRES DO LACZENIA RUR ZE STALI	ITB-KOT-2019/1222	Ø 15 - 108 mm
		RURY I KSZTAŁTKI DN 20 DO DN 50, ZE STALI WĘGLOWEJ OCYNKOWANEJ, SYSTEM STEELPRES	AT-1106-0269/2010/2015	Ø 22 - 54 mm
		SYSTEM OF STEEL PIPES AND STEEL COMPRESSION FITTINGS STEELPRES	STO-30-00114-17	Ø 15 - 108 mm
		SYSTÉM OCEL'OVÝCH RÚR A OCEL'OVÝCH LISOVACÍCH TVAROVIEK STEELPRES	0026/104/2011	Ø 15 - 108 mm
		STEELPRES, PIPING SYSTEM AND FITTING	19-GEI920311-PDA	Ø 15 - 108 mm
		STEELPRES, MECHANICAL JOINTS	ML 20PTB00014	Ø 15 - 108 mm

Campi di applicazione / Fields of application

steelPRES®



Riscaldamento
Heating



Raffrescamento
Cooling



Solare termico con
O-Ring FKM
Solar thermal with
FKM O-Ring



Aria compressa
Compressed air



Antincendio
Fire protection systems *
* no reti idranti / no hydrants systems

steelPRES® O-ring EPDM

Nero | Black | Schwarz | Noir | Negro



**316/005**

≤54 B 40 41

76÷108 B 40 42

**ZINCATO
ESTERNAMENTE**

- OUTSIDE GALVANIZED
- AUSSEN VERZINKT
- GALVANISÉS EXTÉRIEUR
- GALVANIZADO EXTERIOR

NORM: EN 10305-3**Mat. Nr.: 1.0215 (E 220 CR2S4) L=6 m**

CODE	Dimensions mm x mm	Ø int mm	L m	 kg/m	Volume l/m	Minimum package m	Bundle m	€/m
316012005	12 x 1,2	9,6	6	0,320	0,072	150	1014	-
316015005	15 x 1,2	12,6	6	0,408	0,125	120	1014	-
316018005	18 x 1,2	15,6	6	0,497	0,191	90	1014	-
316022005	22 x 1,5	19	6	0,824	0,284	60	762	-
316028005	28 x 1,5	25	6	1,052	0,491	60	546	-
316035005	35 x 1,5	32	6	1,320	0,804	30	546	-
316042005	42 x 1,5	39	6	1,620	1,194	30	366	-
316054005	54 x 1,5	51	6	2,089	2,042	30	366	-
316076005	76,1 x 2,0	72,1	6	3,652	4,080	12	114	-
316088005	88,9 x 2,0	84,9	6	4,290	5,660	12	114	-
316108005	108 x 2,0	104	6	5,230	8,490	6	114	-

Raccomandato per impianti di riscaldamento**Recommended for heating installation****Empfeht fuer Heizunagsanlagen****Recommandé pour installations de chauffage****Recomendado para instalaciones de calefacción**

316/003
≤54 B 40 44
76÷108 B 40 45
**ZINCATO
ESTERNAMENTE CON RIVESTIMENTO
IN PP**

- OUTSIDE GALVANIZED WITH PP-COATING
- AUSSEN VERZINKT MIT PP-UMMANTELUNG
- GALVANISÉS EXTÉRIEUR AVEC REVÊTEMENT PP
- GALVANIZADO EXTERIOR, REVESTIMIENTO DE PP

NORM: EN 10305-3

Mat. Nr.: 1.0215 (E 220 CR2S4) + PP L=6 m

CODE	Dimensions mm x mm	∅ int mm	L m	 kg/m	Volume l/m	Minimum package m	Bundle m	€/m
316012003	12 x 1,2	9,6	6	0,358	0,072	150	900	-
316015003	15 x 1,2	12,6	6	0,454	0,125	120	960	-
316018003	18 x 1,2	15,6	6	0,552	0,191	90	990	-
316022003	22 x 1,5	19	6	0,890	0,284	60	720	-
316028003	28 x 1,5	25	6	1,136	0,491	60	540	-
316035003	35 x 1,5	32	6	1,424	0,804	30	540	-
316042003	42 x 1,5	39	6	1,744	1,194	30	360	-
316054003	54 x 1,5	51	6	2,257	2,042	30	360	-
316076003	76,1 x 2,0	72,1	6	3,875	4,080	12	108	-
316088003	88,9 x 2,0	84,9	6	4,550	5,660	12	108	-
316108003	108 x 2,0	104	6	5,545	8,490	6	114	-

Spessore polipropilene: 1 mm
 Polypropylene thickness: 1 mm
 Dicken polypropylen: 1 mm
 Polypropylène d'épaisseur: 1 mm
 Polipropileno de espesor: 1 mm

Raccomandato per impianti di raffrescamento
Recommended for cooling installation
Empfehl fuer Kuehlungsanlagen
Recommandé pour installations de refroidissement
Recomendado para instalaciones de refrigeracion

**316/002****≤54 B 40 43****76÷108 B 40 46****ZINCATO
INTERNAMENTE ED ESTERNAMENTE**

- INSIDE AND OUTSIDE GALVANIZED
- INNEN UND AUSSEN VERZINKT
- GALVANISÉS INTÉRIEUR ET EXTÉRIEUR
- GALVANIZADO INTERIOR Y EXTERIOR

NORM: EN 10305-3**Mat. Nr.: 1.0031 (E 190 CR2S4) L=6 m**

CODE	Dimensions mm x mm	∅ int mm	L m	 kg/m	Volume l/m	Minimum package m	Bundle m	€/m
316022002	22 x 1,5	19	6	0,824	0,284	60	1770	-
316028002	28 x 1,5	25	6	1,052	0,491	60	1380	-
316035002	35 x 1,5	32	6	1,320	0,804	30	966	-
316042002	42 x 1,5	39	6	1,620	1,194	30	822	-
316054002	54 x 1,5	51	6	2,098	2,042	30	510	-
316076000	76,1 x 2,0	72,1	6	3,652	4,080	12	234	-
316088000	88,9 x 2,0	84,9	6	4,290	5,660	12	210	-
316108000	108 x 2,0	104	6	5,230	8,490	6	150	-

Solo per impianti d'aria compressa e gas inerti.**Only for compressed air and inert gases systems.****Nur für Druckluft und Inertgas.****Seulement pour les systèmes à air comprimé et à gaz inertes.****Sólo para sistemas de aire comprimido y gases inertes.**

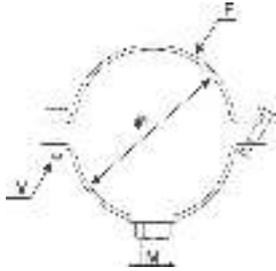

351

COLLARE PER TUBO STEELPRES

- CLAMP FOR STEELPRES PIPE
- ROHRSCHELLE FÜR STEELPRES ROHR
- COLLIER POUR TUBE STEELPRES
- ABRAZADERA PARA TUBO STEELPRES

MATERIAL: St. W 24

NOTE: dado saldato con puntatura elettrica
spot welded nut

CODE	DN mm	F lg x sp mm	V mm				€
351150001 **	15	20 x 2,5	M 6 x 20	60	2	50*	-
351308000	18	20 x 2,5	M 6 x 20	63	2	100*	-
351102000	22	20 x 2,5	M 6 x 20	65	2	100*	-
351304000	28	20 x 2,5	M 6 x 25	69	2	100*	-
351100000	35	20 x 2,5	M 6 x 25	78	2	100*	-
351114000	42	20 x 2,5	M 6 x 25	89	2	50*	-
351054000	54	20 x 2,5	M 6 x 25	100	2	50*	-
351212000	76,1	30 x 2,5	M 6 x 25	187	2	20*	-
351300000	88,9	30 x 2,5	M 6 x 25	215	2	20*	-
351108000	108	30 x 2,5	M 6 x 25	232	2	20*	-

[*] unità minima di vendita / minimum selling quantity

[**] Art. 351150001 Rivestimento in gomma - With rubber gasket - Mit Gummieinlage - Isophonique - Junta de goma (famiglia / family Y 20 25)

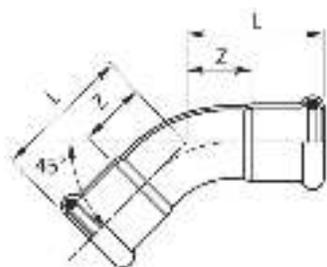
**381/450**

≤54 B 20 21

76÷108 B 20 22

CURVA 45° FF

- 45° ELBOW FF
- BOGEN 45° II
- COUDE FF 45°
- CURVA 45° HH

MATERIAL: E 195 - 1.0034**O-RING:** EPDM nero - black - Schwarz - noir - negro

CODE	De mm	L mm	Z mm				€
381015450	15	27,5	7,5	37	20	400	-
381018450	18	29,5	9,5	45	20	300	-
381022450	22	32	11	59	20	200	-
381028450	28	37	14	87	10	100	-
381035450	35	43	17	124	10	60	-
381042450	42	51	21	175	4	40	-
381054450	54	62	30	282	2	20	-
381076450	76,1	131,5	76,5	910	2	2	-
381088450	88,9	144	84	1125	2	2	-
381108450	108	169	94	1620	2	2	-

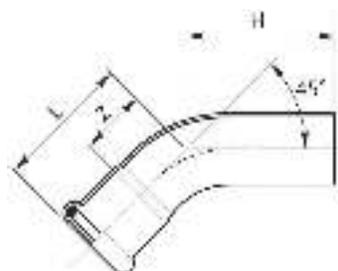
**381/451**

≤54 B 20 21

76÷108 B 20 22

CURVA 45° MF

- 45° ELBOW MF
- BOGEN 45° IA
- COUDE MF 45°
- CURVA 45° HM

MATERIAL: E 195 - 1.0034**O-RING:** EPDM nero - black - Schwarz - noir - negro

CODE	De mm	L mm	H mm	Z mm				€
381015451	15	27,5	36	7,5	39	20	400	-
381018451	18	29,5	38	9,5	46	20	300	-
381022451	22	32	42	11	60	20	200	-
381028451	28	37	46	14	88	10	100	-
381035451	35	43	57	17	135	10	60	-
381042451	42	51	72	21	196	4	40	-
381054451	54	62	82	26	300	2	20	-
381076451	76,1	131,5	149	76,5	870	2	2	-
381088451	88,9	144	159	84	1365	2	2	-
381108451	108	169	199	94	1922	2	2	-

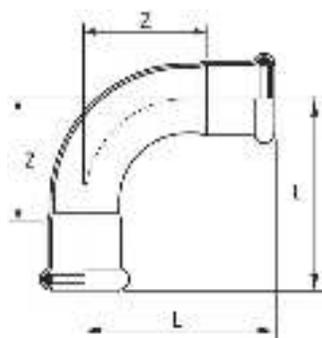

381/900

≤54 B 20 21
76÷108 B 20 22

CURVA 90° FF

- 90° ELBOW FF
- BOGEN 90° II
- COUDE FF 90°
- CURVA 90° HH

MATERIAL: E 195 - 1.0034

O-RING: EPDM nero - black - Schwarz - noir - negro

CODE	De mm	L mm	Z mm				€
381012900	12	42	24	42	20	400	-
381015900	15	38	18	44	20	400	-
381018900	18	41,5	21,5	55	20	300	-
381022900	22	47	26	73	10	150	-
381028900	28	56	33	109	10	100	-
381035900	35	68	42	156	5	50	-
381042900	42	80	50	231	2	30	-
381054900	54	100	64	369	2	18	-
381076900	76,1	160	105	1150	2	2	-
381088900	88,9	182	122	1560	2	2	-
381108900	108	220	145	2250	2	2	-

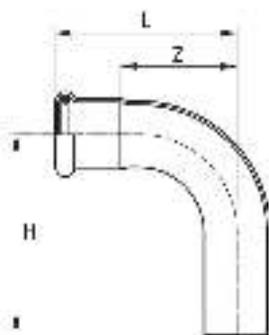

381/901

≤54 B 20 21
76÷108 B 20 22

CURVA 90° MF

- 90° ELBOW MF
- BOGEN 90° IA
- COUDE MF 90°
- CURVA 90° HM

MATERIAL: E 195 - 1.0034

O-RING: EPDM nero - black - Schwarz - noir - negro

CODE	De mm	L mm	H mm	Z mm				€
381012901	12	42	48	24	46	20	400	-
381015901	15	38	48	18	44	20	400	-
381018901	18	41,5	48,5	21,5	56	20	300	-
381022901	22	47	57	26	77	10	150	-
381028901	28	56	64	33	113	10	100	-
381035901	35	68	82	42	174	5	50	-
381042901	42	80	101	50	235	2	30	-
381054901	54	100	120	64	385	2	18	-
381076901	76,1	160	180	105	1155	2	2	-
381088901	88,9	182	197	122	1585	2	2	-
381108901	108	220	236	145	2155	2	2	-

B 20 21

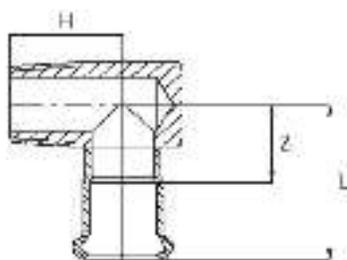
**385****GOMITO MISTO 90° FILETTO M**

- ELBOW ADAPTER 90° WITH MALE THREAD
- ÜBERGANGSWINKEL 90° AG
- EQUERRE 90° AVEC FILETAGE M
- CODO MACHO

MATERIAL: E 195 - 1.0034**O-RING:** EPDM nero - black - Schwarz - noir - negro**THREAD:** EN 10226-1 (ex ISO 7/1)

CODE	De x R mm x inch	L mm	H mm	Z mm				€
385308015	15 x 3/8"	36	21	16	90	20	200	-
385102015	15 x 1/2"	37	26	17	94	20	200	-
385102018	18 x 1/2"	37	26	17	105	10	100	-
385304022	22 x 3/4"	41	29	20	149	10	100	-

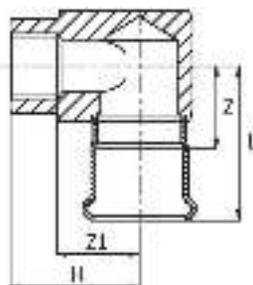
**398****GOMITO MISTO 90° FILETTO F**

- ELBOW ADAPTER 90° WITH FEMALE THREAD
- ÜBERGANGSWINKEL 90° IG
- EQUERRE 90° AVEC FILETAGE F
- CODO HEMBRA

MATERIAL: E 195 - 1.0034**O-RING:** EPDM nero - black - Schwarz - noir - negro**THREAD:** EN 10226-1 (ex ISO 7/1)

CODE	De x Rp mm x inch	L mm	H mm	Z mm	Z1 mm				€
398304022	22 x 3/4"	46	44	25	27	270	10	50	-
398102028	28 x 1/2"	49	42	26	27	300	10	50	-
398304028	28 x 3/4"	49	47	26	30	330	10	50	-

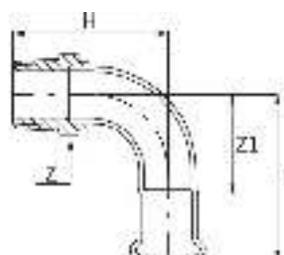
**397****CURVA FILETTATA 90° FILETTO M**

- 90° ELBOW MALE BSP
- BOGEN 90° MIT AG
- COUDE 90° AVEC FILETAGE M
- CODO A 90° MH

MATERIAL: E 195 - 1.0034**O-RING:** EPDM nero - black - Schwarz - noir - negro**THREAD:** EN 10226-1 (ex ISO 7/1)

CODE	De x R mm x inch	L mm	H mm	Z mm	Z1 mm				€
397308012	12 x 3/8"	42	34	22	24	42	20	300	-
397308015	15 x 3/8"	50	47,5	21	30	65	20	300	-
397102015	15 x 1/2"	50	47	21	30	77	20	300	-
397102018	18 x 1/2"	54	52	24	34	92	20	200	-
397304022	22 x 3/4"	60	62	30	39	135	10	100	-
397100028	28 x 1"	73	74	36	50	208	10	50	-
397114035	35 x 1 1/4"	68	80	46	42	262	5	40	-
397112042	42 x 1 1/2"	80	98	60	50	413	2	20	-
397200054	54 x 2"	100	131,5	65	65	482	2	12	-

The **1st** seamless **Pressfitting Tee**

in **carbon steel** and **copper nickel**

steelPRES® MARINE **PRES**®

NO MORE
LEAKS!



For equal/reduced "T"
up to 54 mm



Seamless

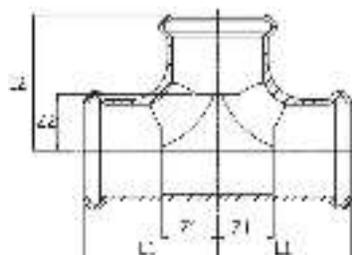

Welded

**382**

≤54 B 20 21

76÷108 B 20 22

"T"

- EQUAL TEE
- T-STÜCK
- TÉ ÉGAL
- TE IGUAL HHH

MATERIAL: E 195 - 1.0034**O-RING:** EPDM nero - black - Schwarz - noir - negro

CODE	De mm	L1 mm	L2 mm	Z1 mm	Z2 mm				€
382012000	12	28	35	10	17	48	20	200	-
382015000*	15	32	32	10,5	10,5	72	20	200	-
382018000*	18	34	34	12,5	12,5	85	20	100	-
382022000*	22	37	37	14,5	14,5	116	20	100	-
382028000*	28	42	42	17,5	17,5	173	10	50	-
382035000*	35	50	50	22,5	22,5	240	4	32	-
382042000*	42	57	57	25,5	25,5	337	4	20	-
382054000*	54	69	69	32,5	32,5	473	2	12	-
382076000	76,1	108	118	52	63	1275	2	2	-
382088000	88,9	132	131	72	71	1535	2	2	-
382108000	108	155	159	74	84	2115	2	2	-

[*] idroformato - hydroformed - hydrogeformt - hydroformé - hidroformado

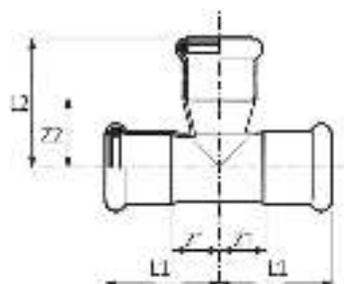
**392/A**

B 20 21

TEE ALLARGATO

- TEE OVERSIZE BRANCH
- T-STÜCK MIT ERWEITERTEM ABGANG
- TÉ AVEC SORTIE ÉVASÉE
- TE CON SALIDA ENSANCHADA

MATERIAL: E 195 - 1.0034**O-RING:** EPDM nero - black - Schwarz - noir - negro

CODE	De mm	L1 mm	L2 mm	Z1 mm	Z2 mm				€
392012015	12 x 15 x 12	28	38	10	17	52	20	100	-
392015018	15 x 18 x 15	37	36	16	15	71	20	100	-
392015022	15 x 22 x 15	37	42	16	19	84	10	100	-
392018022	18 x 22 x 18	40	45	19	22	97	10	100	-
392022028	22 x 28 x 22	41	45	18	21	123	10	50	-

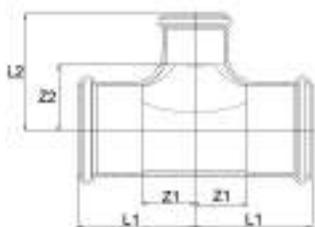

392

≤54 B 20 21
76÷108 B 20 22

“T” RIDOTTO

- REDUCING TEE
- T-STÜCK MIT REDUZIERTEM ABGANG
- TÉ RÉDUIT
- TE REDUCIDA HHH

MATERIAL: E 195 - 1.0034

O-RING: EPDM nero - black - Schwarz - noir - negro

CODE	De mm	L1 mm	L2 mm	Z1 mm	Z2 mm				€
392015012	15 x 12 x 15	37	33	16	15	64	20	100	-
392018012	18 x 12 x 18	40	34	19	16	72	20	100	-
392018015*	18 x 15 x 18	34	35	12,5	13,5	83	20	100	-
392022012	22 x 12 x 22	41	36	18	18	94	10	100	-
392022015*	22 x 15 x 22	37	38	14,5	16,5	110	10	100	-
392022018*	22 x 18 x 22	37	38	14,5	16	112	10	100	-
392028015*	28 x 15 x 28	42	40,5	17,5	19	146	10	50	-
392028018*	28 x 18 x 28	42	40,5	17,5	19	150	10	50	-
392028022*	28 x 22 x 28	42	41	17,5	20	155	10	50	-
392035015	35 x 15 x 35	50	44	24	24	205	5	50	-
392035018*	35 x 18 x 35	50	44	24	24	191	5	50	-
392035022*	35 x 22 x 35	50	44	22,5	23	207	5	50	-
392035028*	35 x 28 x 35	50	44	22,5	19,5	213	5	35	-
392042022*	42 x 22 x 42	57	53	25,5	30,5	285	4	20	-
392042028*	42 x 28 x 42	57	56	25,5	38	295	4	20	-
392042035*	42 x 35 x 42	57	61	25,5	33,5	311	4	20	-
392054022*	54 x 22 x 54	69	59	32,5	36,5	420	2	16	-
392054028*	54 x 28 x 54	69	64	32,5	39,5	432	2	16	-
392054035*	54 x 35 x 54	69	67	32,5	39,5	443	2	16	-
392054042*	54 x 42 x 54	69	70	32,5	38,5	461	2	16	-
392076022	76,1 x 22 x 76,1	108	74	52	53	995	2	2	-
392076028	76,1 x 28 x 76,1	108	77	52	54	1015	2	2	-
392076035	76,1 x 35 x 76,1	108	80	52	54	1025	2	2	-
392076042	76,1 x 42 x 76,1	108	84	52	54	1045	2	2	-
392076054	76,1 x 54 x 76,1	108	90	52	55	1065	2	2	-
392088028	88,9 x 28 x 88,9	132	84	72	61	1365	2	2	-
392088035	88,9 x 35 x 88,9	132	88	72	62	1395	2	2	-
392088042	88,9 x 42 x 88,9	132	91	72	61	1425	2	2	-
392088054	88,9 x 54 x 88,9	132	97	72	62	1455	2	2	-
392088076	88,9 x 76,1 x 88,9	132	125	72	70	1485	2	2	-
392108028	108 x 28 x 108	155	94	74	71	1815	2	2	-
392108035	108 x 35 x 108	155	97	74	71	1845	2	2	-
392108042	108 x 42 x 108	155	101	74	71	1875	2	2	-
392108054	108 x 54 x 108	155	107	74	72	1905	2	2	-
392108076	108 x 76 x 108	155	135	74	80	1935	2	2	-
392108088	108 x 88,9 x 108	155	141	74	81	1965	2	2	-

[*] idroformato - hydroformed - hydrogeformt - hydroformé - hidroformado

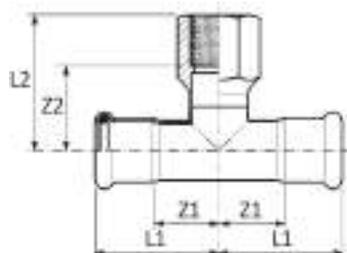

389

≤54 B 20 21

76÷108 B 20 22

"T" CON DERIVAZIONE FILETTO F

- BRANCH TEE FEMALE BSP OUTLET
- T-STÜCK MIT ABGANG IG
- TÉ MIXTE AVEC FILETAGE F
- TE HEMBRA ROSCADA

MATERIAL: E 195 - 1.0034

O-RING: EPDM nero - black - Schwarz - noir - negro

THREAD: EN 10226-1 (ex ISO 7/1)

CODE	De x Rp x De mm x inch x mm	L1 mm	L2 mm	Z1 mm	Z2 mm				€
389102015	15 x 1/2" x 15	35	36	14	21	72	20	100	-
389102018	18 x 1/2" x 18	37	38	16	23	91	20	100	-
389102022	22 x 1/2" x 22	39	39	18	24	128	10	100	-
389304022	22 x 3/4" x 22	39	44	18	28	133	10	100	-
389102028	28 x 1/2" x 28	44	42	21	27	158	10	50	-
389304028	28 x 3/4" x 28	44	47	21	30	161	10	50	-
389100028	28 x 1" x 28	44	53	21	34	246	5	50	-
389102035	35 x 1/2" x 35	51	45	25	30	200	5	50	-
389304035	35 x 3/4" x 35	51	50	25	34	191	5	40	-
389100035	35 x 1" x 35	51	56	25	37	250	5	40	-
389102042	42 x 1/2" x 42	59	49	28	34	255	4	32	-
389304042	42 x 3/4" x 42	59	54	28	37	255	4	32	-
389102054	54 x 1/2" x 54	70	56	34	41	300	2	14	-
389304054	54 x 3/4" x 54	70	61	34	45	353	2	14	-
389100054	54 x 1" x 54	70	56	34	41	441	2	14	-
389102076	76,1 x 1/2" x 76,1	108	68	52	53	1040	2	2	-
389304076	76,1 x 3/4" x 76,1	108	77	52	60	1040	2	2	-
389102088	88,9 x 1/2" x 88,9	132	76	72	61	1255	2	2	-
389304088	88,9 x 3/4" x 88,9	132	84	72	68	1255	2	2	-
389102108	108 x 1/2" x 108	155	85	74	70	1700	2	2	-
389304108	108 x 3/4" x 108	155	94	74	77	1700	2	2	-

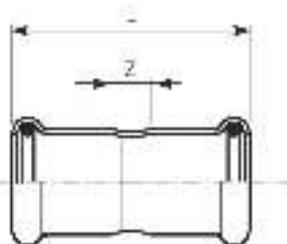

383/000

≤54 B 20 21
76÷108 B 20 22

MANICOTTO

- COUPLING
- MUFFE
- MANCHON
- MANGUITO HH

MATERIAL: E 195 - 1.0034

O-RING: EPDM nero - black - Schwarz - noir - negro

CODE	De mm	L mm	Z mm	 g			€
383012000	12	42	6	25	20	500	-
383015000	15	49	9	33	20	500	-
383018000	18	50	10	40	20	300	-
383022000	22	53	11	52	20	200	-
383028000	28	56	10	69	10	150	-
383035000	35	63	10	90	10	100	-
383042000	42	72	12	127	4	60	-
383054000	54	83	13	189	2	24	-
383076000	76,1	142	32	635	4	4	-
383088000	88,9	166	46	765	4	4	-
383108000	108	203	41	1170	2	2	-

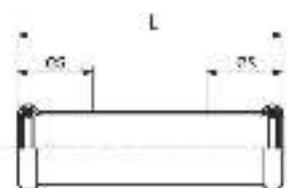

383/001

≤54 B 20 21
76÷108 B 20 22

MANICOTTO PASSANTE

- SLIP COUPLING
- SCHIEBEMUFFE
- MANCHON LONG
- MANGUITO SIN TOPE

MATERIAL: E 195 - 1.0034

O-RING: EPDM nero - black - Schwarz - noir - negro

CODE	De mm	L mm	es mm	 g			€
383012001	12	56	22	42	20	500	-
383015001	15	69	25	56	20	200	-
383018001	18	73	25	65	20	200	-
383022001	22	79	25	85	20	100	-
383028001	28	88,5	30	118	10	100	-
383035001	35	102,5	30	141	10	50	-
383042001	42	117,5	40	234	4	40	-
383054001	54	139	40	321	4	20	-
383076001	76,1	230	60	940	2	2	-
383088001	88,9	260	70	1240	2	2	-
383108001	108	310	80	1835	2	2	-

B 20 21

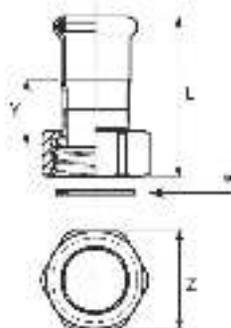
**383/002****MANICOTTO CON DADO FOLLE**

- VALVE CONNECTOR
- ANSCHLUSSVERSCHRAUBUNG
- RACCORD ÉCROU LIBRE
- RÁCOR DOS PIEZAS

MATERIAL: E 195 - 1.0034**O-RING:** EPDM nero - black - Schwarz - noir - negro**GASKET:** [*]: EPDM nero - black - Schwarz - noir - negro**THREAD:** ISO 228/1 (ex DIN 259)

CODE	De x G mm x inch	L mm	Z mm	Y mm	Gasket mm				€
383015002	15 x 3/4"	37	30	10	24x14 thk 2,5	60	10	250	-
383018002	18 x 3/4"	37	30	10	24x14 thk 2,5	68	10	250	-
383022012	22 x 3/4"	54	30	25	24x14 thk 2,5	103	10	200	-
383022002	22 x 1"	40	36	10	30x20 thk 2,5	86	10	200	-
383022022	22 x 1 1/2"	42,5	55	14	44,5x30 thk 2,5	305	10	80	-
383028012	28 x 1"	58	36	27	30x20 thk 2,5	142	10	150	-
383028002	28 x 1 1/4"	47	46	14	39x27 thk 2,5	136	10	150	-
383028022	28 x 1 1/2"	48	55	14	44,5x30 thk 2,5	300	10	60	-
383035012	35 x 1 1/4"	67	46	32	39x27 thk 2,5	237	4	60	-
383035002	35 x 1 1/2"	52	55	14	44,5x30 thk 2,5	292	4	60	-
383042022	42 x 1 1/2"	77	55	35	44,5x30 thk 2,5	422	2	40	-
383042002	42 x 1 3/4"	55	60	14	50,5x38 thk 2,5	360	2	60	-
383042012	42 x 2"	56	65	14,5	56x42 thk 2,5	310	2	40	-
383054012	54 x 2"	83	65	36,5	56x42 thk 2,5	475	2	30	-
383054002	54 x 2 3/8"	60	75	15	65,5x45 thk 3	442	2	40	-
383054022	54 x 2 1/2"	65,5	81	16	71,5x53 thk 3	537	2	24	-

**383/003****TAPPO DI CHIUSURA**

- STOP END
- VERSCHLUSSKAPPE
- BOUCHON D'OBTURATION
- TAPÓN

MATERIAL: E 195 - 1.0034**O-RING:** EPDM nero - black - Schwarz - noir - negro

≤54 B 20 21

76÷108 B 20 22

CODE	De mm	L mm	L1 mm				€
383012003	12	30	13	21	20	500	-
383015003	15	26	5	28	20	500	-
383018003	18	26	5	30	10	300	-
383022003	22	27	5	40	10	200	-
383028003	28	29	5	57	10	150	-
383035003	35	32	5	80	5	100	-
383042003	42	36	5	115	4	80	-
383054003	54	41	5	177	4	40	-
383076003	76,1	78	6	540	2	10	-
383088003	88,9	88	6	730	2	10	-
383108003	108	102	6	935	2	2	-

B 20 21

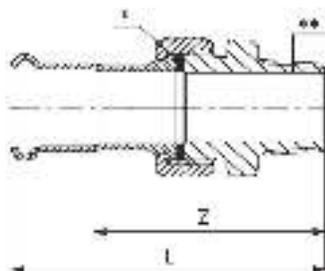

384/000

BOCCHETTONE SEDE PIANA FILETTO M

- STRAIGHT MALE UNION CONNECTOR
- DURCHGANGSVERSCHRAUBUNG MIT AUSSENGEWINDE
- RACCORD UNION FILETÉ
- RÁCOR 3 PIEZAS ROSCADO MACHO

MATERIAL: E 195 - 1.0034

FITTING: [**]: ottone - brass - Messing - laiton - latón

O-RING: EPDM nero - black - Schwarz - noir - negro

GASKET: [*]: EPDM nero - black - Schwarz - noir - negro

THREAD: EN 10226-1 (ex ISO 7/1)

CODE	De x R mm x inch	L mm	Z mm	Gasket mm				€
384015000	15 x 1/2"	64	44	24x14 thk 2,5	146	2	120	-
384018000	18 x 1/2"	64	44	24x14 thk 2,5	176	2	120	-
384022000	22 x 3/4"	69	46	30x20 thk 2,5	202	2	100	-
384028000	28 x 1"	80	56	39x27 thk 2,5	468	2	60	-
384035000	35 x 1 1/4"	89	62	44,5x30 thk 2,5	618	2	40	-
384042000	42 x 1 1/2"	93	61	50,5x38 thk 2,5	824	2	30	-
384054000	54 x 2"	104	66	65,5x45 thk 3	1178	2	20	-

B 20 21

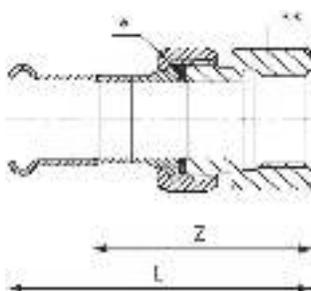

384/001

BOCCHETTONE SEDE PIANA FILETTO F

- STRAIGHT FEMALE UNION CONNECTOR
- DURCHGANGSVERSCHRAUBUNG MIT INNENGEWINDE
- RACCORD UNION TARAUDÉ
- RÁCOR 3 PIEZAS HEMBRA

MATERIAL: E 195 - 1.0034

FITTING: [**]: ottone - brass - Messing - laiton - latón

O-RING: EPDM nero - black - Schwarz - noir - negro

GASKET: [*]: EPDM nero - black - Schwarz - noir - negro

THREAD: EN 10226-1 (ex ISO 7/1)

CODE	De x Rp mm x inch	L mm	Z mm	Gasket mm				€
384015001	15 x 1/2"	59	38	24x14 thk 2,5	138	2	120	-
384018001	18 x 1/2"	59	38	24x14 thk 2,5	140	2	120	-
384022001	22 x 3/4"	64	41	30x20 thk 2,5	209	2	100	-
384028001	28 x 1"	73	49	39x27 thk 2,5	450	2	60	-
384035001	35 x 1 1/4"	81	54	44,5x30 thk 2,5	600	2	40	-
384042001	42 x 1 1/2"	85	53	50,5x38 thk 2,5	621	2	30	-
384054001	54 x 2"	102	66	65,5x45 thk 3	1189	2	20	-

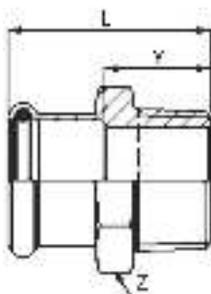
**387**

≤54 B 20 21

76÷108 B 20 22

**MANICOTTO MISTO
FILETTO M**

- MALE ADAPTER
- ÜBERGANGSSTÜCK MIT AG
- RACCORD AVEC FILETAGE MALE
- UNIÓN MACHO

MATERIAL: E 195 - 1.0034**O-RING:** EPDM nero - black - Schwarz - noir - negro**THREAD:** EN 10226-1 (ex ISO 7/1)

CODE	De x R mm x inch	L mm	Z mm	Y mm				€
387308012	12 x 3/8"	38	19	21	41	20	300	-
387308015	15 x 3/8"	41	24	21	58	20	400	-
387102015	15 x 1/2"	44	24	24	65	20	300	-
387304015	15 x 3/4"	44	27	24	78	10	200	-
387102018	18 x 1/2"	44	27	24	72	20	300	-
387304018	18 x 3/4"	45	30	25	107	10	200	-
387102022	22 x 1/2"	42	32	21	60	10	200	-
387304022	22 x 3/4"	45	32	25	93	10	200	-
387100022	22 x 1"	46	36	25	154	10	100	-
387304028	28 x 3/4"	47	38	24	114	10	100	-
387100028	28 x 1"	48	38	25	116	10	100	-
387114028	28 x 1"1/4	52	46	29	195	5	50	-
387100035	35 x 1"	52	46	25	169	5	50	-
387114035	35 x 1"1/4	56	46	29	205	5	50	-
387112035	35 x 1"1/2	55	50	28	220	5	50	-
387112042	42 x 1"1/2	63	55	33	250	4	40	-
387200054	54 x 2"	72	65	36	356	4	32	-
387212076	76,1 x 2"1/2	98	83	43	752	2	8	-
387300088	88,9 x 3"	111	98	51	1191	2	4	-
387400108	108 x 4"	132	118	57	1802	2	2	-

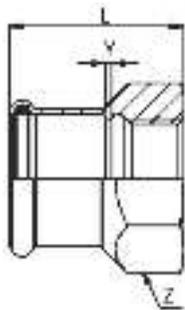

390

MANICOTTO MISTO FILETTO F

- FEMALE ADAPTER
- ÜBERGANGSSTÜCK MIT IG
- RACCORD AVEC FILETAGE FEMELLE
- UNIÓN HEMBRA

MATERIAL: E 195 - 1.0034
O-RING: EPDM nero - black - Schwarz - noir - negro
THREAD: EN 10226-1 (ex ISO 7/1)

CODE	De x Rp mm x inch	L mm	Z mm	Y mm	g			€
390102012	12 x 1/2"	38	27	3	55	20	300	-
390308015	15 x 3/8"	35	24	2	48	20	300	-
390102015	15 x 1/2"	38	27	2	60	20	300	-
390304015	15 x 3/4"	39	32	2	78	10	200	-
390102018	18 x 1/2"	38	27	2	60	20	300	-
390304018	18 x 3/4"	39	32	2	78	10	200	-
390102022	22 x 1/2"	39	32	2	96	10	200	-
390304022	22 x 3/4"	40	32	2	81	10	150	-
390100022	22 x 1"	43	41	2	147	10	100	-
390102028	28 x 1/2"	41	38	2	155	10	100	-
390304028	28 x 3/4"	42	38	2	132	10	100	-
390100028	28 x 1"	45	41	2	147	10	100	-
390100035	35 x 1"	51	46	2	218	5	50	-
390114035	35 x 1"1/4	52	46	2	154	5	50	-
390112042	42 x 1"1/2	56	55	2	245	4	40	-
390200054	54 x 2"	65	65	2	329	4	32	-

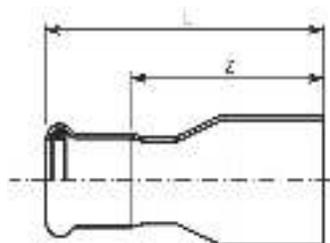
**391**

≤54 B 20 21

76÷108 B 20 22

RIDUZIONE MF

- REDUCER
- REDUZIERSTÜCK
- REDUCTION
- REDUCCIÓN MH

MATERIAL: E 195 - 1.0034**O-RING:** EPDM nero - black - Schwarz - noir - negro

CODE	De mm	L mm	Z mm				€
391015012	15 x 12	51	33	29	20	500	-
391018012	18 x 12	53	35	32	20	500	-
391018015	18 x 15	57	37	36	20	500	-
391022012	22 x 12	60	42	41	20	300	-
391022015	22 x 15	64	44	45	20	300	-
391022018	22 x 18	60	40	48	20	300	-
391028015	28 x 15	76,5	56,5	50	20	200	-
391028018	28 x 18	68	48	62	20	200	-
391028022	28 x 22	65	42,5	59	20	200	-
391035022	35 x 22	70	49	89	10	100	-
391035028	35 x 28	71	48	91	10	100	-
391042022	42 x 22	97	76	120	4	80	-
391042028	42 x 28	93	70	127	4	80	-
391042035	42 x 35	81	55	130	4	40	-
391054022	54 x 22	104	83	192	4	40	-
391054028	54 x 28	108,5	85,5	155	4	40	-
391054035	54 x 35	108	82	189	4	40	-
391054042	54 x 42	97,5	67,5	205	4	32	-
391076042	76,1 x 42	157	127	506	4	4	-
391076054	76,1 x 54	159	124	517	4	4	-
391088054	88,9 x 54	179	143	667	4	4	-
391088076	88,9 x 76,1	184	129	792	4	4	-
391108076	108 x 76,1	203	148	983	2	2	-
391108088	108 x 88,9	207	147	1079	2	2	-

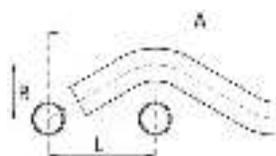
**379**

B 20 21

"S" DI SCAVALCAMENTO MM

- PIPE BRIDGE
- SPRUNGBOGEN
- "S" DE CHEVAUCHEMENT MALE
- "S" DE SUPERPOSICIÓN MM

MATERIAL: E 195 - 1.0034

CODE	De mm	L mm	A mm	B mm				€
379012000	12	55	154	35	10	10	150	-
379015000	15	57	158	30	14	10	150	-
379018000	18	60	166	31	17	10	100	-
379022000	22	65	179	33	29	10	100	-
379028000	28	73	206	36	44	10	50	-

B 20 21

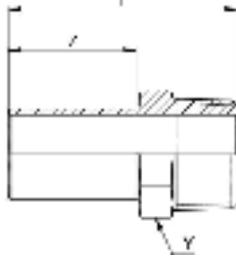

393/M

MANICOTTO CON INSERIMENTO FILETTO M

- MALE REDUCTION SOCKET
- ÜBERGANG AUSSENGEWINDE MIT EINSCHUBENDE
- MANCHON DE RÉDUCTION FILETÉ
- ADAPTADOR MACHO

MATERIAL: E 195 - 1.0034
THREAD: EN 10226-1 (ex ISO 7/1)

CODE	De x R mm x inch	L mm	Z mm	Y mm				€
393102115	15 x 1/2"	52	31	22	56	20	300	-
393102118	18 x 1/2"	52	31	22	49	20	300	-
393304118	18 x 3/4"	55	31	27	93	20	200	-
393102122	22 x 1/2"	55	32	27	68	10	200	-
393304122	22 x 3/4"	56	32	27	78	10	200	-
393100128	28 x 1"	64	37	38	141	10	100	-

B 20 21

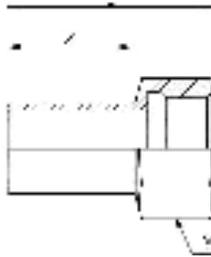

393/F

MANICOTTO CON INSERIMENTO FILETTO F

- FEMALE REDUCTION SOCKET
- ÜBERGANG INNENGEWINDE MIT EINSCHUBENDE
- MANCHON DE RÉDUCTION AVEC TARAUDAGE
- ADAPTADOR HEMBRA

MATERIAL: E 195 - 1.0034
THREAD: EN 10226-1 (ex ISO 7/1)

CODE	De x Rp mm x inch	L mm	Z mm	Y mm				€
393102015	15 x 1/2"	52	37	24	49	20	400	-
393102018	18 x 1/2"	52	37	24	50	20	400	-
393304018	18 x 3/4"	51	37	30	62	20	300	-
393102022	22 x 1/2"	52	37	24	51	20	300	-
393304022	22 x 3/4"	52	38	30	63	20	300	-

B 20 21

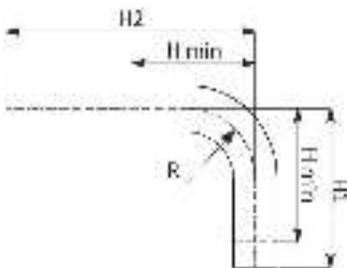

394/900

TUBO CURVO 90°

- 90° ELBOW MM
- PASSBOGEN 90°
- COUDE D'AJUSTEMENT 90°
- TUBO RICURVO 90° MM

MATERIAL: E 195 - 1.0034

CODE	De mm	H1 mm	Hmin mm	H2 mm	R mm				€
394015900	15	70	48	120	35	87	20	160	-
394018900	18	70	53	120	38	105	20	120	-
394022900	22	70	61	120	40	130	10	100	-
394028900	28	97	80	125	45	197	10	50	-
394035900	35	120	90	200	42	372	4	20	-
394042900	42	160	115	250	50	578	2	10	-
394054900	54	300	140	305	65	1114	2	2	-

B 20 21

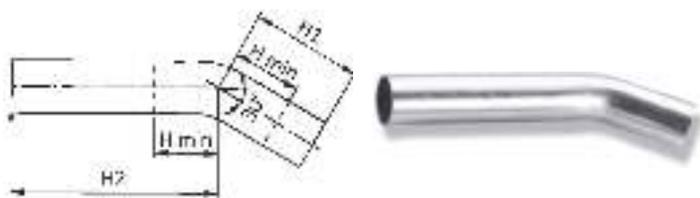

394/300

TUBO CURVO 30°

- 30° ELBOW MM
- PASSBOGEN 30°
- COUDE D'AJUSTEMENT 30°
- TUBO RICURVO 30° MM

MATERIAL: E 195 - 1.0034

CODE	De mm	H1 mm	H min mm	H2 mm	g			€
394028300	28	54	47	130	179	10	50	-
394035300	35	80	50	218	366	4	24	-
394042300	42	98	54	274	553	2	10	-
394054300	54	137	72	324	888	2	2	-

B 20 21



394/150

TUBO CURVO 15°

- 15° ELBOW MM
- PASSBOGEN 15°
- COUDE D'AJUSTEMENT 15°
- TUBO RICURVO 15° MM

MATERIAL: E 195 - 1.0034

CODE	De mm	H1 mm	H min mm	H2 mm	g			€
394028150	28	45	38	136	176	10	50	-
394035150	35	62	32	234	364	4	24	-
394042150	42	94	50	276	551	2	10	-
394054150	54	117	52	337	876	2	2	-

≤54 B 20 21

76÷108 B 20 22

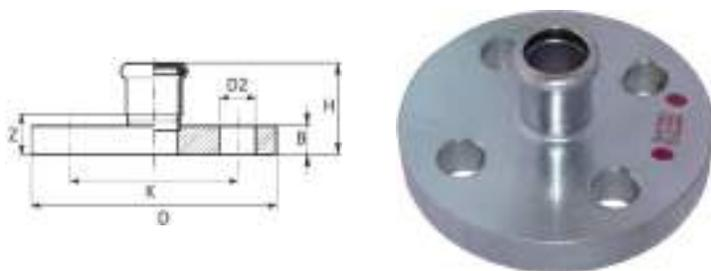

393/002

MANICOTTO FLANGIATO

- ADAPTOR FLANGE
- ÜBERGANGSFLANSCH
- BRIDE DE RACCORDEMENT
- BRIDA ADAPTADOR

MATERIAL: E 195 - 1.0034

O-RING: EPDM nero - black - Schwarz - noir - negro

PN 6

CODE	De mm	DN flg	H mm	Z mm	B mm	D mm	D2 mm	Holes Nr.	K mm	g			€
393015002	15	15	39	19	12	80	11	4	55	434	2	20	-
393018002	18	15	39,5	19,5	12	80	11	4	55	431	2	20	-
393022002	22	20	42,5	21,5	14	90	11	4	65	636	2	14	-
393028002	28	25	45,5	22,5	14	100	11	4	75	784	2	10	-
393035002	35	32	51	25,5	16	120	14	4	90	1259	2	6	-
393042002	42	40	55	25	16	130	14	4	100	1472	2	6	-
393054002	54	50	62	26	16	140	14	4	110	1657	2	4	-
393076002	76,1	65	100,5	45,5	14	160	14	4	130	1849	2	2	-
393088002	88,9	80	112	52	16	190	18	4	150	2879	2	2	-
393108002	108	100	128	53	16	210	18	4	170	3488	2	2	-

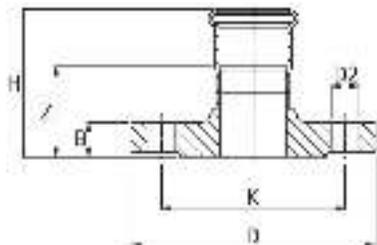

393/000

≤54 B 20 21
76÷108 B 20 22

MANICOTTO FLANGIATO

- ADAPTOR FLANGE
- ÜBERGANGSFLANSCH
- BRIDE DE RACCORDEMENT
- BRIDA ADAPTADOR

MATERIAL: E 195 - 1.0034

O-RING: EPDM nero - black - Schwarz - noir - negro

PN 16

CODE	De mm	DN flg	H mm	Z mm	B mm	D mm	D2 mm	Holes Nr.	K mm				€
393015000	15	15	43	23	16	95	14	4	65	578	2	20	-
393018000	18	15	44	24	16	95	14	4	65	572	2	20	-
393022000	22	20	47	26	18	105	14	4	75	754	2	14	-
393028000	28	25	50	27	18	115	14	4	85	1094	2	10	-
393035000	35	32	53	27	18	140	18	4	100	1672	2	6	-
393042000	42	40	57	27	18	150	18	4	110	1988	2	6	-
393054000	54	50	64	28	18	165	18	4	125	2666	2	4	-
393076000	76,1	65	104,5	49,5	18	185	18	8	145	2994	2	2	-
393088000	88,9	80	116	56	20	200	18	8	160	3861	2	2	-
393108000	108	100	132	57	20	220	18	8	180	4623	2	2	-



434/PN 6

R 30 30

GUARNIZIONE ECOLOGICA PER FLANGE

- GASKET FOR FLANGE
- FLANSCHDICHTUNG
- JOINT POUR BRIDE
- JUNTA ECOLÓGICA PARA BRIDA

MATERIAL: Sesalit Eco

NORM: EN 1092-1

PN 6

CODE	DN	De mm	Di mm	S mm			€
434015006	15 - [1/2"]	44	20	2	4	10	-
434020006	20 - [3/4"]	54	25	2	6	10	-
434025006	25 - [1"]	64	30	2	9	10	-
434032006	32 - [1 1/4"]	75	38	2	11	10	-
434040006	40 - [1 1/2"]	85	45	2	14	10	-
434050006	50 - [2"]	95	57	2	15	10	-
434065006	65 - [2 1/2"]	115	76	2	19	10	-
434080006	80 - [3"]	132	89	2	26	10	-
434100006	100 - [4"]	152	108	2	29	10	-

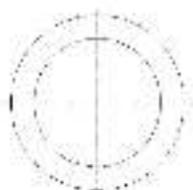
**PN
10/16**

434/PN10-16

R 30 30

GUARNIZIONE ECOLOGICA PER FLANGE

- GASKET FOR FLANGE
- FLANSCHDICHTUNG
- JOINT POUR BRIDE
- JUNTA ECOLÓGICA PARA BRIDA

MATERIAL: Sesalit Eco
NORM: EN 1092-1

CODE	DN	De mm	Di mm	S mm			€
434015000	15 - (1/2")	50	20	2	6	10	-
434020000	20 - (3/4")	60	25	2	8	10	-
434025000	25 - (1")	70	30	2	10	10	-
434032000	32 - (1 1/4")	82	38	2	14	10	-
434040000	40 - (1 1/2")	92	45	2	17	10	-
434050000	50 - (2")	108	57	2	22	10	-
434065000	65 - (2 1/2")	127	76	2	27	10	-
434080000	80 - (3")	142	89	2	30	10	-
434100000	100 - (4")	162	108	2	38	10	-

Sesalit ECO: fibre organiche e sintetiche legate con gomma NBR/SBR esente amianto

IMPIEGHI: Acqua calda e fredda, olii vegetali ed animali, aria, alcuni carburanti (no GAS)

LIMITI DI TEMPERATURA ORIENTATIVI

Temperatura massima per brevi esposizioni: 180°-200° C

Temperatura massima di esercizio continuo per fluidi non aggressivi: 140° C

Temperatura massima di esercizio continuo con vapore: 110° C

OMOLOGAZIONI: acqua potabile WRAS n° 1605525

Sesalit ECO: organic and synthetic fibers bonded with NBR/SBR asbestos-free

USES: hot and cold water, vegetable and animal oils, air, some fuels (no GAS)

GUIDELINE TEMPERATURE LIMITS

Maximum temperature for short exposure: 180°-200° C

Maximum operating temperature for continuous non-aggressive fluids: 140° C

Maximum temperature for continuous operation with steam: 110° C

APPROVAL: potable water WRAS n° 1605525

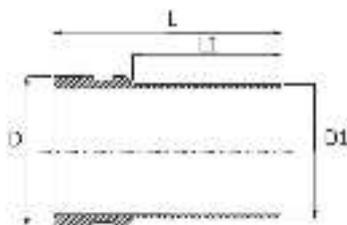

322

B 20 22

RACCORDO DI TRANSIZIONE STEELPRES TUBAZIONI SCANALATE A GIUNTI RAPIDI

- TRANSITION PIECE STEELPRES/COUPLINGS
- ÜBERGANG STEELPRES/KUPPLUNG
- RACORD DE PASAGE ENTRE STEELPRES ET TUBE CANNELÉ
- RÁCOR DE TRANSICIÓN STEELPRES/TUBERIA CANALADA

MATERIAL: E 275+N-1.0225

CODE	D mm	DI mm	L mm	L1 mm				€
322060042	60	42	120	69	410	1	25	-
322060054	60	54	120	80	410	1	20	-
322076054	76	54	130	76	585	1	15	-

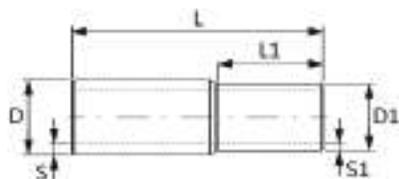

375

≤54 B 20 21
76÷108 B 20 22

**GIUNTO A SALDARE
SENZA ZINCATURA**

- COMBINATION PIPE WELDING END (NOT GALVANIZED)
- KOMBIROHR MIT ANSCHWEISSENDE (NICHT VERZINKT)
- TUBE RÉDUIT AVEC EXTRÉMITÉ À SOUDER (NON GALVANISÉ)
- UNIÓN A SALDAR SIN ZINCADURA

MATERIAL: E 195 - 1.0034

CODE	D mm	D1 mm	S mm	S1 mm	L1 mm	L mm	g	kg	box	€
375308012	17,2	12	4,1	1,5	26	120	124	10	100	-
375308015	17,2	15	2,6	1,5	30	120	89	10	100	-
375102018	21,3	18	3,15	1,5	30	120	132	10	100	-
375304022	26,9	22	3,95	1,5	34	120	216	10	100	-
375100028	33,7	28	4,35	1,5	34	120	303	5	80	-
375114035	42,4	35	5,2	1,5	40	120	423	5	50	-
375112042	48,3	42	4,65	1,5	45	120	438	5	40	-
375200054	60,3	54	4,65	1,5	50	120	537	2	24	-
375212076	76,1	76,1	3,7	2	70	120	570	2	24	-
375300088	88,9	88,9	4,1	2	75	120	692	2	12	-
375400108	114,3	108	5,2	2	90	120	842	2	10	-

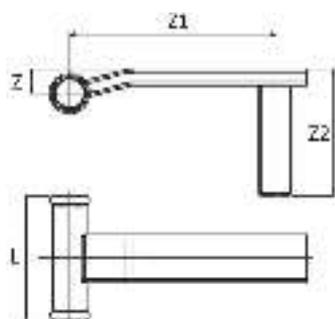

396/RAD

B 20 21

ATTACCO VERNICIATO PER RADIATORE

- PAINTED RADIATOR CONNECTOR
- HEIZUNGSANSCHLUSS LACKIERT
- CONNECTEUR PEINT DE RADIATEUR
- CONECTADOR PINTADO DEL RADIADOR

MATERIAL: E 195 - 1.0034

O-RING: EPDM nero - black - Schwarz - noir - negro

CODE	De mm	L mm	Z mm	Z1 mm	Z2 mm	g	kg	box	€
396102015V	15 x 1/2"	80	16	131	82	224	1	50	-
396102018V	18 x 1/2"	80	16	131	82	236	1	50	-

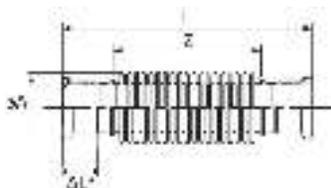

199

≤54 B 10 11

76÷108 B 10 12

COMPENSATORE DI DILATAZIONE

- EXPANSION COMPENSATOR
- WELLENKOMPENSATOR
- COMPENSATEUR D'EXPANSION
- DILATADOR

MATERIAL: AISI 316L - 1.4404**O-RING:** EPDM nero - black - Schwarz - noir - negro

CODE	De mm	L mm	ΔL* mm	Cycles**	Z mm	A mm				€
199015000	15	139	16	800	71	22	80	1	100	-
199018000	18	143	18	800	74	27	108	1	80	-
199022000	22	139	20	800	68	34	130	1	80	-
199028000	28	150	22	800	73	41	155	1	40	-
199035000	35	177	26	800	90	51	251	1	24	-
199042000	42	202	32	800	107	61	440	1	16	-
199054000	54	221	36	800	113	71	550	1	12	-
199076000	76,1	278	30	500	180	87	1464	1	1	-
199088000	88,9	314	40	500	235	105	1871	1	1	-
199108000	108	388	50	500	255	131	2845	1	1	-

(*) Corsa assiale in compressione - Compression axial stroke - Axialhub in Kompression - Course axiale en compression - Carrera axial en compresión

(**) Numero di cicli di lavoro alla massima compressione - Work cycles number at maximum compression - Anzahl der Zyklen bei einer maximaler Kompression - Nombre de cycles de travail à compression maximale - Número de ciclos de trabajo a máxima compresión

Sono concessi singoli raccordi in acciaio inox inseriti in un impianto in acciaio al carbonio.

Single joints in stainless steel are accepted inside a carbon steel installations.

Einzelne Fittinge Inox in einer Carbon-Anlage sind zulässig.

Sont concedes les raccords simples inox inseres dans l'installation carbone.

Se aceptan accesorios independientes de inox / cobre / cuproniquel insertados en una instalación de acero carbono.

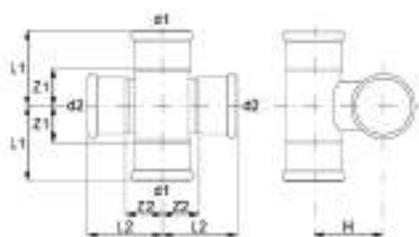

399

B 20 21

CROCE A 90°

- CROSSOVER 90°
- KREUZSTÜCH 90°
- CROIX 90°
- CRUZ 90°

MATERIAL: E 195 - 1.0034**O-RING:** EPDM nero - black - Schwarz - noir - negro

CODE	d1 - d2	L1 mm	L2 mm	Z1 mm	Z2 mm	H mm				€
399015015	15 x 15	34,5	34,5	14,5	14,5	20	92	10	100	-
399018015	18 x 15	36,5	34,5	16,5	14,5	21,5	102	10	100	-
399022015	22 x 15	39,5	34,5	18,5	14,5	24	121	10	80	-
399022018	22 x 18	39,5	36,5	18,5	16,5	25,5	131	10	80	-
399028015	28 x 15	44	34,5	21	14,5	26,5	150	10	50	-
399028018	28 x 18	44	36,5	21	16,5	28	160	10	50	-

B 20 21

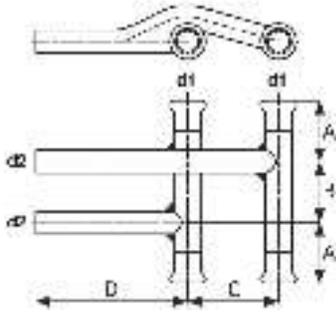

395

SCAVALCO SINGOLO

- SINGLE CROSSING
- HEIZKÖRPERANSCHLUSS
- RACCORDEMENT SINGLE ALLÉE ET RETOUR
- MANGUITO C/ CURVA DESVIACIÓN

MATERIAL: E 195 - 1.0034

O-RING: EPDM nero - black - Schwarz - noir - negro

CODE	d1 - d2	A mm	B mm	C mm	D mm				€
395012012	12 x 12	30	40	60	100	205	1	30	-
395015012	15 x 12	40	40	60	100	244	1	30	-
395015015	15 x 15	40	40	60	100	266	1	30	-
395018012	18 x 12	40	40	60	100	276	1	25	-
395018015	18 x 15	40	40	60	100	298	1	25	-
395022012	22 x 12	40	40	60	100	322	1	20	-
395022015	22 x 15	40	40	60	100	340	1	20	-
395028012	28 x 12	40	40	60	100	374	1	20	-
395028015	28 x 15	40	40	60	100	394	1	15	-

B 20 21

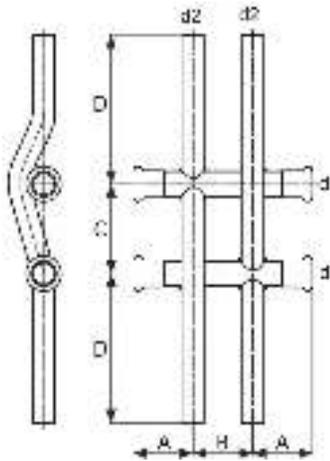

396

SCAVALCO DOPPIO

- DOUBLE CROSSING
- KREUZFITTING
- RACCORDEMENT DOUBLE ALLÉE ET RETOUR
- MANGUITO C/ CURVA DESVIACIÓN DOBLE

MATERIAL: E 195 - 1.0034

O-RING: EPDM nero - black - Schwarz - noir - negro

CODE	d1 - d2	A mm	B mm	C mm	D mm				€
396012012	12 x 12	30	40	60	100	280	1	20	-
396015012	15 x 12	40	40	60	100	318	1	20	-
396015015	15 x 15	40	40	60	100	376	1	20	-
396018012	18 x 12	40	40	60	100	355	1	20	-
396018015	18 x 15	40	40	60	100	410	1	15	-
396022012	22 x 12	40	40	60	100	380	1	15	-
396022015	22 x 15	40	40	60	100	436	1	15	-
396028012	28 x 12	40	40	60	100	452	1	10	-
396028015	28 x 15	40	40	60	100	494	1	10	-
396035015	35 x 15	40	40	60	100	556	1	10	-

Certificazioni / Certifications

		PRODUKTE DER WASSERVERSORGUNG	DW-8511CL0331	Ø 15 – 54 mm
		AESPRES RANGE OF COMPRESSION FITTINGS	1806312	Ø 15 – 54 mm
		PRESSFITTINGS, TYPE AESPRES	n°1988	Ø 15 – 54 mm
		PRESS-FITTINGS AESPRES	K 83136/03	Ø 15 – 54 mm
		PRESSFITTINGS TIL KOBBRØR Ø 15-54 MM	VA 1.22/20514	Ø 15 – 54 mm
		AESPRES, PRESSKOPPLING Ø 15-54 MM	SC0265-16	Ø 15 – 54 mm
		RACCORDI A PRESSARE IN RAME-BRONZO / COPPER-BRONZE PRESSFITTINGS PRODOTTI E COMPONENTI UTILIZZATI A CONTATTO CON ACQUA POTABILE PRODUCT AND ELEMENTS IN CONTACT WITH DRINKING WATER	ICIM-CAP-009671-00	Ø 12 – 54 mm
		AESPRES PRESSFITTING SYSTEM	POCC.IT.AM05.H05079	Ø 15 – 108 mm

Campi di applicazione / Fields of application

AES PRES®



Acqua potabile
Potable water



Riscaldamento
Heating



Raffrescamento
Cooling



Solare termico con
O-Ring FKM
Solar thermal
with FKM O-Ring



Aria compressa
Compressed Air



Antincendio
Fire protection systems

AES PRES® O-ring EPDM

Nero | Black | Schwarz | Noir | Negro



FOCUS ON
TUBO RAME PER AESPRES - AESPRES GAS / AESPRES - AESPRES GAS COPPER PIPING

Le tubazioni per impianti acqua e gas in rame, devono essere rispondenti alla norma UNI EN 1057:2010.

Rame e leghe di rame - Tubi rotondi di rame senza saldatura per acqua e gas nelle applicazioni sanitarie e di riscaldamento.

Piping for copper water and gas installation should comply with the standard EN 1057:2010, "Copper and copper alloys - Round tubes in copper without welding for water and gas in health-care and heating applications".

TABELLA 4: CARATTERISTICHE DEI TUBI DI RAME - EN 1057

Classe di resistenza <i>Resistance class</i>	Stato di fornitura <i>Delivery condition</i>	ϕ (mm)
R220	Ricotto - Rotoli <i>Annealed - Roll</i>	12 ÷ 22
R250	Semiduro - Barre <i>Semi-hard - Bar</i>	12 ÷ 28
R290	Duro - Barre <i>Hard - Bar</i>	12 ÷ 54

Classe di resistenza <i>Resistance class</i>	Resistenza minima alla trazione <i>Minimum traction resistance Rm (MPa)</i>	Allungamento minimo alla rottura <i>Minimum breaking elongation (%)</i>
R220	220	40
R250	250	20
R290	290	3

Le dimensioni dei tubi utilizzabili con i sistemi a pressare **Aespres** ed **Aespres Gas** sono espote nella tabella sottostante.
Tube sizes to be used with Aespres and Aespres Gas press fittings are included in the annexed table.

DIMENSIONI DEI TUBI DI RAME - EN 1057 / DVGW GW 392
AESPRES PIPES DIMENSIONS AND CHARACTERISTICS - EN 1057 / DVGW GW 392

ϕ ESTERNO x SP. <i>EXTERNAL ϕ x THK.</i> mm	DN	ϕ INTERNO <i>INTERNAL ϕ</i> mm	MASSA <i>MASS</i> kg/m	CONTENUTO D'ACQUA <i>WATER VOLUME</i> l/m	STATO FORNITURA <i>SUPPLIED CONDITION</i>
12x1	10	10	0,309	0,079	Rotolo / Roll 25/50 m (R 220) o / or
15x1	12	13	0,393	0,133	
18x1	15	16	0,477	0,201	
22x1	20	20	0,589	0,314	Barra / Bar 5 m (R 250 - R 290)
28x1,5	25	25	1,115	0,491	Barra / Bar 5 m (R 250 - R 290)
35x1,5	32	32	1,410	0,804	Barra / Bar 5 m (R 290)
42x1,5	40	39	1,704	1,194	
54x2	50	50	2,918	1,963	

B 7071

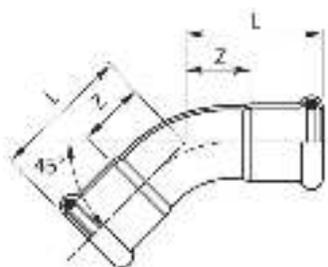
**681/450****CURVA 45° FF**

- 45° ELBOW FF
- BOGEN 45° II
- COUDE FF 45°
- CURVA 45° HH

MATERIAL: Cu-DHP99,9 - CW024A**O-RING:** EPDM nero - black - Schwarz
noir - negro

CODE	De mm	L mm	Z mm				€
681012450	12	32	14	38	20	400	-
681015450	15	27,5	7,5	36	20	400	-
681018450	18	29,5	9,5	53	20	300	-
681022450	22	32	11	71	20	100	-
681028450	28	37	14	101	10	100	-
681035450	35	43,5	17,5	138	10	60	-
681042450	42	51	21	200	4	40	-
681054450	54	62	26,5	306	2	20	-

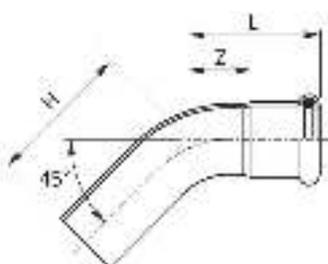
**681/451****CURVA 45° MF**

- 45° ELBOW MF
- BOGEN 45° IA
- COUDE MF 45°
- CURVA 45° HM

MATERIAL: Cu-DHP99,9 - CW024A**O-RING:** EPDM nero - black - Schwarz
noir - negro

B 7071

CODE	De mm	L mm	H mm	Z mm				€
681012451	12	32	41	14	36	20	400	-
681015451	15	27,5	40	7,5	41	20	400	-
681018451	18	29,5	36	9,5	50	20	300	-
681022451	22	32	42	11	69	20	200	-
681028451	28	37	46	14	99	10	100	-
681035451	35	43,5	57,5	17,5	144	10	60	-
681042451	42	51	72	21	215	4	40	-
681054451	54	62	82	26,5	333	2	20	-

B 70 71

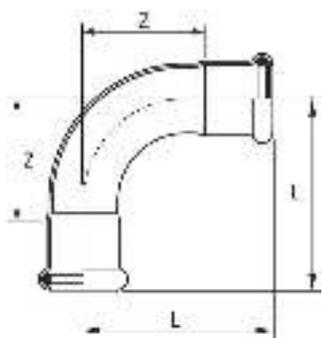

681/900

CURVA 90° FF

- 90° ELBOW FF
- BOGEN 90° II
- COUDE FF 90°
- CURVA 90° HH

MATERIAL: Cu-DHP99,9 - CW024A
O-RING: EPDM nero - black - Schwarz
 noir - negro

CODE	De mm	L mm	Z mm	g	kg	Box	€
681012900	12	42	24	28	20	400	-
681015900	15	38	18	51	20	400	-
681018900	18	41,5	21,5	62	20	300	-
681022900	22	47	26	88	10	150	-
681028900	28	56	33	128	10	100	-
681035900	35	68	42	180	5	50	-
681042900	42	80	50	265	2	30	-
681054900	54	100	64,5	419	2	18	-

B 70 71

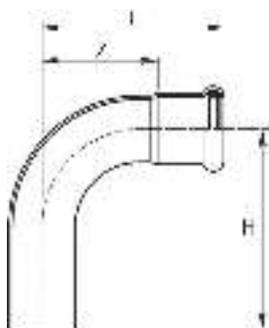

681/901

CURVA 90° MF

- 90° ELBOW MF
- BOGEN 90° IA
- COUDE MF 90°
- CURVA 90° HM

MATERIAL: Cu-DHP99,9 - CW024A
O-RING: EPDM nero - black - Schwarz
 noir - negro

CODE	De mm	L mm	H mm	Z mm	g	kg	Box	€
681012901	12	42	48	24	40	20	400	-
681015901	15	38	48	18	49	20	400	-
681018901	18	41,5	48,5	21,5	62	20	300	-
681022901	22	47	57	26	87	10	150	-
681028901	28	56	64	33	130	10	100	-
681035901	35	68	82	42	195	5	50	-
681042901	42	80	101	50	278	2	30	-
681054901	54	100	120	64,5	435	2	18	-

B 7071

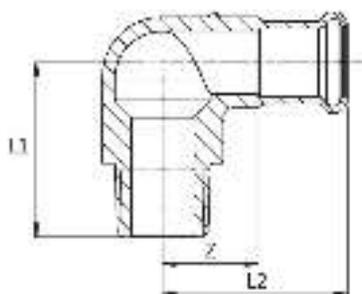

697

GOMITO MISTO 90° FILETTO M

- ELBOW ADAPTER 90° WITH MALE THREAD
- ÜBERGANGSWINKEL 90° AG
- EQUERRE 90° AVEC FILETAGE M
- CODO MACHO

MATERIAL: CuSn5Zn5Pb2-C - CC499K

O-RING: EPDM nero - black - Schwarz
noir - negro

THREAD: EN 10226-1 (ex ISO 7/1)

CODE	De x R mm x inch	L1 mm	L2 mm	Z mm				€
697308012	12 x 3/8"	35	34	14	86	10	200	-
697102012	12 x 1/2"	40	34	14	113	10	150	-
697308015	15 x 3/8"	35	41,5	21,5	86	10	150	-
697102015	15 x 1/2"	38,5	41,5	21,5	131	10	120	-
697102018	18 x 1/2"	40	42	22	136	10	100	-
697304018	18 x 3/4"	44	42	22	177	10	100	-
697102022	22 x 1/2"	42	42	21	162	10	100	-
697304022	22 x 3/4"	47	42	21	193	10	80	-
697102028	28 x 1/2"	45	47	24	199	10	80	-
697100028	28 x 1"	53	45	24	318	5	50	-
697114035	35 x 1"1/4	68	55	29	471	5	40	-
697112042	42 x 1"1/2	75	65	35	660	2	24	-
697200054	54 x 2"	88	78	42	1078	2	20	-

B 7071

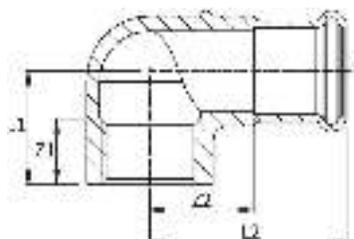

698

GOMITO MISTO 90° FILETTO F

- ELBOW ADAPTER 90° WITH FEMALE THREAD
- ÜBERGANGSWINKEL 90° IG
- EQUERRE 90° AVEC FILETAGE F
- CODO HEMBRA

MATERIAL: CuSn5Zn5Pb2-C - CC499K

O-RING: EPDM nero - black - Schwarz
noir - negro

THREAD: EN 10226-1 (ex ISO 7/1)

CODE	De x Rp mm x inch	L1 mm	L2 mm	Z1 mm	Z2 mm				€
698308012	12 x 3/8"	22,5	34	12	14	72	10	200	-
698102012	12 x 1/2"	24	34	16	14	87	10	200	-
698308015	15 x 3/8"	22,5	41,5	12	21,5	87	10	150	-
698102015	15 x 1/2"	22,5	41,5	16	21,5	102	10	150	-
698304015	15 x 3/4"	25	41,5	16	21,5	125	10	100	-
698102018	18 x 1/2"	24	42	16	22	112	10	150	-
698304018	18 x 3/4"	26	42	16	22	133	10	100	-
698102022	22 x 1/2"	26	42	15	21	129	10	100	-
698304022	22 x 3/4"	29	42	16	21	152	10	100	-
698100022	22 x 1"	32	45	19	24	203	10	80	-
698102028	28 x 1/2"	29	47	16	24	168	5	50	-
698100028	28 x 1"	35	48	19	25	240	5	50	-
698114035	35 x 1"1/4	45	55	23	29	403	5	40	-
698112042	42 x 1"1/2	52	65	23	35	541	2	30	-
698200054	54 x 2"	60	78	27	42	1085	2	16	-

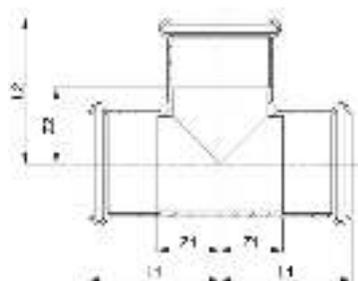

682

B 70 71

“T”

- EQUAL TEE
- T-STÜCK
- TÉ ÉGAL
- TE IGUAL HHH

MATERIAL: Cu-DHP99,9 - CW024A

O-RING: EPDM nero - black - Schwarz
noir - negro

CODE	De mm	L1 mm	L2 mm	Z1 mm	Z2 mm				€
682012000	12	31	31	11	11	54	20	200	-
682015000	15	32	32	13,5	12	75	20	200	-
682018000	18	34	34	13,5	14	96	20	100	-
682022000	22	37	37	16	16	125	10	100	-
682028000	28	42	42	19	19	174	10	50	-
682035000	35	50	50	24	24	245	4	32	-
682042000	42	57	63	27	33	345	4	20	-
682054000	54	69	78	33,5	42	559	2	12	-

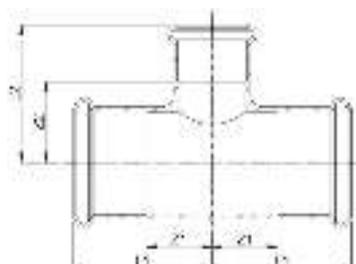

692

B 70 71

“T” RIDOTTO

- REDUCING TEE
- T-STÜCK MIT REDUZIERTEM ABGANG
- TÉ RÉDUIT
- TE REDUCIDA HHH

MATERIAL: Cu-DHP99,9 - CW024A

O-RING: EPDM nero - black - Schwarz
noir - negro

CODE	De mm	L1 mm	L2 mm	Z1 mm	Z2 mm				€
692015012	15 x 12 x 15	32	32	12	12	69	20	100	-
692018012	18 x 12 x 18	34	35	14	15	84	20	100	-
692018015	18 x 15 x 18	34	35	14	15	93	20	100	-
692022012	22 x 12 x 22	37	35	16	15	106	10	100	-
692022015	22 x 15 x 22	37	38	16	18	122	10	100	-
692022018	22 x 18 x 22	37	38	16	18	128	10	100	-
692028015	28 x 15 x 28	42	40,5	19	20,5	167	10	50	-
692028018	28 x 18 x 28	42	40,5	19	20,5	168	10	50	-
692028022	28 x 22 x 28	42	41	19	20	173	10	50	-
692035015	35 x 15 x 35	50	44	24	24	250	5	50	-
692035018	35 x 18 x 35	50	44	24	24	241	5	50	-
692035022	35 x 22 x 35	50	44	24	23	237	5	50	-
692035028	35 x 28 x 35	50	44	24	21	231	5	35	-
692042015	42 x 15 x 42	57	47,5	27	27,5	338	4	20	-
692042018	42 x 18 x 42	57	47,5	27	27,5	338	4	20	-
692042022	42 x 22 x 42	57	53	27	32	330	4	20	-
692042028	42 x 28 x 42	57	56	27	33	323	4	20	-
692042035	42 x 35 x 42	57	61	27	35	338	4	20	-
692054022	54 x 22 x 54	69	59	33,5	38	469	2	16	-
692054028	54 x 28 x 54	69	64	33,5	41	465	2	16	-
692054035	54 x 35 x 54	69	67	33,5	41	502	2	16	-
692054042	54 x 42 x 54	69	70	33,5	40	489	2	16	-

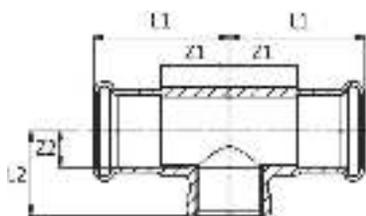

689

"T" CON DERIVAZIONE FILETTO F

- BRANCH TEE FEMALE BSP OUTLET
- T-STÜCK MIT ABGANG IG
- TÉ MIXTE AVEC FILETAGE F
- TE HEMBRA ROSCADA

MATERIAL: CuSn5Zn5Pb2-C - CC 499K

O-RING: EPDM nero - black - Schwarz
noir - negro

THREAD: EN 10226-1 (ex ISO 7/1)

CODE	De x Rp x De mm x inch x mm	L1 mm	L2 mm	Z1 mm	Z2 mm				€
689102012	12 x 1/2" x 12	34	24	14	10	104	10	100	-
689308015	15 x 3/8" x 15	41,5	22,5	21,5	10,5	118	10	100	-
689102015	15 x 1/2" x 15	41,5	22,5	21,5	8,5	128	10	100	-
689102018	18 x 1/2" x 18	42	24	22	10	145	10	100	-
689102022	22 x 1/2" x 22	42	26	21	12	170	10	100	-
689304022	22 x 3/4" x 22	42	30	21	14	183	10	100	-
689102028	28 x 1/2" x 28	44	29	21	15	211	5	50	-
689304028	28 x 3/4" x 28	44	30	21	14	216	5	50	-
689100028	28 x 1" x 28	44	34	21	16	265	5	50	-
689102035	35 x 1/2" x 35	50	34	24	19	308	5	50	-
689304035	35 x 3/4" x 35	50	34	24	18	305	5	40	-
689100035	35 x 1" x 35	50	35	24	17	329	5	40	-
689102042	42 x 1/2" x 42	57	38	27	23	419	4	32	-
689304042	42 x 3/4" x 42	57	38	27	22	415	4	32	-
689102054	54 x 1/2" x 54	69	44	33	30	638	2	14	-
689304054	54 x 3/4" x 54	69	44	33	28	639	2	14	-

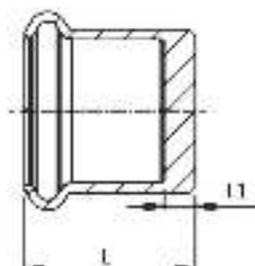

683/003

TAPPO DI CHIUSURA

- STOP END
- VERSCHLUSSKAPPE
- BOUCHON D'OBTURATION
- TAPÓN

MATERIAL: Cu-DHP99,9 - CW024A

O-RING: EPDM nero - black - Schwarz
noir - negro

CODE	De mm	L mm	L1 mm				€
683012003	12	20	3	14	20	500	-
683015003	15	22,5	2,5	20	20	500	-
683018003	18	23	3	25	20	300	-
683022003	22	24,5	2,5	34	10	200	-
683028003	28	26,5	3,5	49	10	150	-
683035003	35	28,5	2,5	65	5	100	-
683042003	42	32,5	2,5	93	4	80	-
683054003	54	37,5	2,5	147	4	40	-

B 70 71

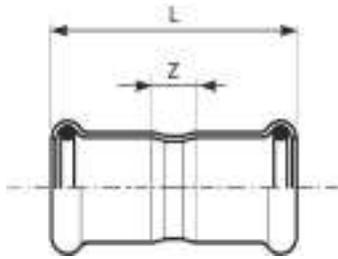

683/000

MANICOTTO

- COUPLING
- MUFFE
- MANCHON
- MANGUITO HH

MATERIAL: Cu-DHP99,9 - CW024A
O-RING: EPDM nero - black - Schwarz
 noir - negro

CODE	De mm	L mm	Z mm	 g			€
683012000	12	42	6	38	20	400	-
683015000	15	49	9	39	20	400	-
683018000	18	50	10	47	20	300	-
683022000	22	53	11	62	20	200	-
683028000	28	56	10	84	10	150	-
683035000	35	63	10	108	10	100	-
683042000	42	72	12	156	4	60	-
683054000	54	83	13	225	2	24	-

B 70 71

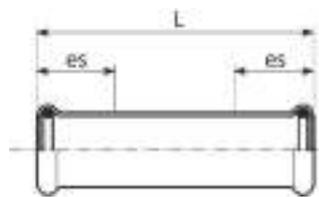

683/001

MANICOTTO PASSANTE

- SLIP COUPLING
- SCHIEBEMUFFE
- MANCHON LONG
- MANGUITO SIN TOPE

MATERIAL: Cu-DHP99,9 - CW024A
O-RING: EPDM nero - black - Schwarz
 noir - negro

CODE	De mm	L mm	es mm	 g			€
683012001	12	56	22	33	20	500	-
683015001	15	80	25	58	20	200	-
683018001	18	80	25	66	20	200	-
683022001	22	80	25	80	20	100	-
683028001	28	90	30	110	10	100	-
683035001	35	102	30	167	10	50	-
683042001	42	120	40	223	4	40	-
683054001	54	140	40	333	4	20	-

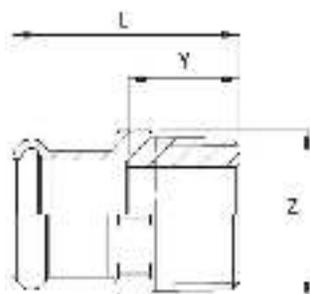
**687****MANICOTTO MISTO FILETTO M**

- MALE ADAPTER
- ÜBERGANGSSTÜCK MIT AG
- RACCORD AVEC FILETAGE MALE
- UNIÓN MACHO

MATERIAL: CuSn5Zn5Pb2-C - CC499K**O-RING:** EPDM nero - black - Schwarz
noir - negro**THREAD:** EN 10226-1 (ex ISO 7/1)

CODE	De x R mm x inch	L mm	Z mm	Y mm	g	kg	box	€
687308012	12 x 3/8"	32	17	12	31	20	400	-
687102012	12 x 1/2"	36	22	16	48	20	400	-
687308015	15 x 3/8"	32	21	12	32	20	400	-
687102015	15 x 1/2"	36	22	16	53	20	300	-
687304015	15 x 3/4"	37,5	27	17,5	74	20	240	-
687102018	18 x 1/2"	37	22	17	47	20	300	-
687304018	18 x 3/4"	38	27	18	65	10	200	-
687102022	22 x 1/2"	36	27	17	58	10	200	-
687304022	22 x 3/4"	39	27	18	64	10	200	-
687100022	22 x 1"	42,5	34	21,5	111	10	100	-
687304028	28 x 3/4"	42	34	19	93	10	100	-
687100028	28 x 1"	44,5	34	21,5	105	10	100	-
687114028	28 x 1"1/4	48	43	25	192	10	100	-
687100035	35 x 1"	48	40	22	139	5	50	-
687114035	35 x 1"1/4	50	43	24	182	5	50	-
687112035	35 x 1"1/2	51	50	25	239	5	50	-
687114042	42 x 1"1/4	54	50	24	223	4	40	-
687112042	42 x 1"1/2	54	51	24	215	4	40	-
687112054	54 x 1"1/2	60	63	24	316	4	32	-
687200054	54 x 2"	63,5	63	33	341	4	32	-

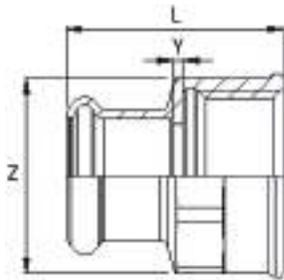

690

MANICOTTO MISTO FILETTO F

- FEMALE ADAPTER
- ÜBERGANGSSTÜCK MIT IG
- RACCORD AVEC FILETAGE FEMELLE
- UNIÓN HEMBRA

MATERIAL: CuSn5Zn5Pb2-C - CC499K
O-RING: EPDM nero - black - Schwarz
 noir - negro
THREAD: EN 10226-1 (ex ISO 7/1)

CODE	De x Rp mm x inch	L mm	Z mm	Y mm				€
690308012	12 x 3/8"	33,5	21	2	38	20	400	-
690102012	12 x 1/2"	36	26	2	58	20	300	-
690308015	15 x 3/8"	33,5	21	2	38	20	300	-
690102015	15 x 1/2"	36	26	2	58	20	300	-
690304015	15 x 3/4"	39	31	2	76	10	200	-
690102018	18 x 1/2"	37	26	2	61	20	300	-
690304018	18 x 3/4"	39	31	2	77	10	200	-
690102022	22 x 1/2"	36	27	1,5	64	20	200	-
690304022	22 x 3/4"	39	31	2,5	76	10	150	-
690100022	22 x 1"	42,5	38	2	112	10	100	-
690102028	28 x 1/2"	39	34	1	98	20	100	-
690304028	28 x 3/4"	41,5	34	2	98	10	100	-
690100028	28 x 1"	45	38	2,5	122	10	100	-
690114028	28 x 1"1/4	48	46	3	162	10	100	-
690100035	35 x 1"	45	40	2	132	5	100	-
690114035	35 x 1"1/4	50	46	2	164	5	100	-
690114042	42 x 1"1/4	54	50	2	198	4	40	-
690112042	42 x 1"1/2	54	53	2	217	4	40	-
690200054	54 x 2"	65	65	3	342	4	32	-

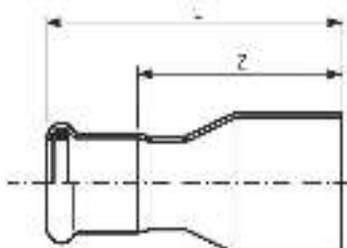

691

RIDUZIONE MF

- REDUCER
- REDUZIERSTÜCK
- REDUCTION
- REDUCCIÓN MH

MATERIAL: Cu-DHP99,9 - CW024A

O-RING: EPDM nero - black - Schwarz
noir - negro

CODE	De mm	L mm	Z mm				€
691015012	15 x 12	51	31	20	20	500	-
691018012	18 x 12	53	33	36	20	500	-
691018015	18 x 15	57	37	42	20	500	-
691022015	22 x 15	64	44	53	20	400	-
691022018	22 x 18	59,5	39,5	52	20	300	-
691028015	28 x 15	54	34	48	20	200	-
691028018	28 x 18	53	33	54	20	200	-
691028022	28 x 22	65	44	72	20	200	-
691035022	35 x 22	59	38	68	10	100	-
691035028	35 x 28	71	48	98	10	100	-
691042022	42 x 22	66	45	97	4	80	-
691042028	42 x 28	65	42	99	4	80	-
691042035	42 x 35	80,5	54,5	137	4	40	-
691054022	54 x 22	74	53	154	4	40	-
691054028	54 x 28	70	47	148	4	40	-
691054035	54 x 35	76	50	159	4	40	-
691054042	54 x 42	97,5	67,5	204	4	32	-

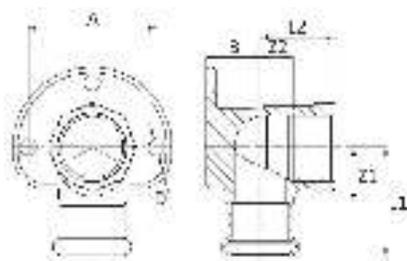

685

GOMITO MISTO 90° FF

- WALL PLATE ELBOW 90° WITH FEMALE THREAD
- DECKENWINKEL 90° IG
- EQUERRE 90° FF
- CODO PLACA HH

MATERIAL: CuSn5Zn5Pb2-C - CC499K

O-RING: EPDM nero - black - Schwarz
noir - negro

THREAD: EN 10226-1 (ex ISO 7/1)

CODE	De x Rp mm x inch	L1 mm	L2 mm	Z1 mm	Z2 mm	A mm	B mm	D mm				€
685102012	12 x 1/2"	34	24	14	9	40	12	6,5	155	10	100	-
685102015	15 x 1/2"	41,5	22,5	21,5	7	40	14	6,5	172	10	100	-
685102018	18 x 1/2"	42	24	22	9	40	15	6,5	188	10	100	-
685304022	22 x 3/4"	42	29	21	13	50	21	6,5	249	10	50	-
685100022	22 x 1"	45	32	24	13	50	30	6,5	315	10	50	-
685100028	28 x 1"	48	35	25	16	50	30	6,5	366	5	50	-

B 70 71

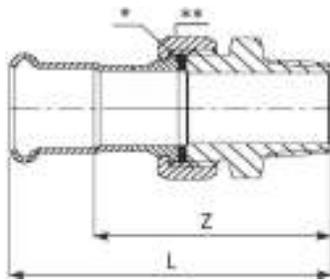

684/002

BOCCHETTONE SEDE PIANA FILETTO M

- STRAIGHT MALE UNION CONNECTOR
- DURCHGANGSVERSCHRAUBUNG MIT AUSSENGEWINDE
- RACCORD UNION FILETÉ
- RÁCOR 3 PIEZAS ROSCADO MACHO

MATERIAL: CuSn5Zn5Pb2-C - CC499K

FITTING: (**): ottone - brass - Messing
 laiton - latón

O-RING: EPDM nero - black - Schwarz
 noir - negro

GASKET: (*): EPDM nero - black - Schwarz
 noir - negro

THREAD: EN 10226-1 (ex ISO 7/1)

CODE	De x R mm x inch	L mm	Z mm	Gasket mm	g			€
684015002	15 x 1/2"	66	46	24x14 thk 2,5	164	2	100	-
684015012	15 x 3/4"	67	47	24x14 thk 2,5	195	2	80	-
684018002	18 x 1/2"	65,5	45,5	24x14 thk 2,5	160	2	80	-
684018012	18 x 3/4"	66,5	46,5	24x14 thk 2,5	191	2	80	-
684022002	22 x 3/4"	67	46	30x20 thk 2,5	252	2	60	-
684022012	22 x 1"	68,5	47,5	30x20 thk 2,5	242	2	60	-
684028002	28 x 1"	80	56	39x27 thk 2,5	432	2	40	-
684035002	35 x 1"1/4	89	62	44,5x30 thk 2,5	684	2	20	-
684042002	42 x 1"1/2	92,5	62,5	50,5x38 thk 2,5	716	2	20	-
684054002	54 x 2"	106	70	65,5x45 thk 3	1344	2	12	-

B 70 71

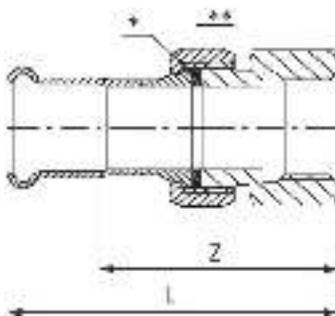

684/003

BOCCHETTONE SEDE PIANA FILETTO F

- STRAIGHT FEMALE UNION CONNECTOR
- DURCHGANGSVERSCHRAUBUNG MIT INNENGEWINDE
- RACCORD UNION TARAUDÉ
- RÁCOR 3 PIEZAS HEMBRA

MATERIAL: CuSn5Zn5Pb2-C - CC499K

FITTING: (**): ottone - brass - Messing
 laiton - latón

O-RING: EPDM nero - black - Schwarz
 noir - negro

GASKET: (*): EPDM nero - black - Schwarz
 noir - negro

THREAD: EN 10226-1 (ex ISO 7/1)

CODE	De x Rp mm x inch	L mm	Z mm	Gasket mm	g			€
684012003	12 x 3/8"	59,5	39,5	18x10 thk 2,5	156	2	100	-
684012013	12 x 1/2"	59,5	39,5	18x10 thk 2,5	142	2	100	-
684015003	15 x 1/2"	60,5	40,5	24x14 thk 2,5	170	2	100	-
684015013	15 x 3/4"	62,5	42,5	24x14 thk 2,5	191	2	100	-
684018003	18 x 1/2"	62	42	24x14 thk 2,5	168	2	100	-
684018013	18 x 3/4"	62	42	24x14 thk 2,5	185	2	100	-
684022003	22 x 1/2"	62,5	41,5	30x20 thk 2,5	299	2	60	-
684022013	22 x 3/4"	63,5	42,5	30x20 thk 2,5	250	2	60	-
684022023	22 x 1"	67,5	46,5	30x20 thk 2,5	273	2	60	-
684028003	28 x 1"	73	49	39x27 thk 2,5	481	2	40	-
684035003	35 x 1"1/4	81	54	44,5x30 thk 2,5	638	2	24	-
684042003	42 x 1"1/2	84,5	54,5	50,5x38 thk 2,5	682	2	24	-
684054003	54 x 2"	104	68	65,5x45 thk 3	1355	2	12	-

Certificazioni / Certifications

		PRODUKTE DER GASVERSORGUNG	DG-8531CL0376	Ø 15 – 54 mm
		RACCORDI A PRESSARE PER GAS - PLUMBING FITTINGS FOR GASES	CA06.00293	Ø 15 – 54 mm
		AESPRES GAS - WITH O-RING NBR	C-16-3742-A	Ø 15 – 54 mm
		COPPER AND BRONZE PRESS CONNECTORS	13/16	Ø 15 – 54 mm
		PRESS FITTINGS FOR JOINING COPPER PIPES	100351/02	Ø 15 – 54 mm

Campi di applicazione / Fields of applicationAES PRES[®] GASGas metano / GPL
Natural gas / LPGAES PRES[®] GAS O-ring NBR

Giallo | Yellow | Gelb | Jaune | Amarillo



FOCUS ON
TUBO RAME PER AESPRES - AESPRES GAS / AESPRES - AESPRES GAS COPPER PIPING

Le tubazioni per impianti acqua e gas in rame, devono essere rispondenti alla norma UNI EN 1057:2010.

Rame e leghe di rame - Tubi rotondi di rame senza saldatura per acqua e gas nelle applicazioni sanitarie e di riscaldamento.

Piping for copper water and gas installation should comply with the standard EN 1057:2010, "Copper and copper alloys - Round tubes in copper without welding for water and gas in health-care and heating applications".

TABELLA 4: CARATTERISTICHE DEI TUBI DI RAME - EN 1057

Classe di resistenza <i>Resistance class</i>	Stato di fornitura <i>Delivery condition</i>	ϕ (mm)
R220	Ricotto - Rotoli <i>Annealed - Roll</i>	12 ÷ 22
R250	Semiduro - Barre <i>Semi-hard - Bar</i>	12 ÷ 28
R290	Duro - Barre <i>Hard - Bar</i>	12 ÷ 54

Classe di resistenza <i>Resistance class</i>	Resistenza minima alla trazione <i>Minimum traction resistance Rm (MPa)</i>	Allungamento minimo alla rottura <i>Minimum breaking elongation (%)</i>
R220	220	40
R250	250	20
R290	290	3

Le dimensioni dei tubi utilizzabili con i sistemi a pressare **Aespres** ed **Aespres Gas** sono espresse nella tabella sottostante.
Tube sizes to be used with Aespres and Aespres Gas press fittings are included in the annexed table.

DIMENSIONI DEI TUBI DI RAME - EN 1057 / DVGW GW 392
AESPRES PIPES DIMENSIONS AND CHARACTERISTICS - EN 1057 / DVGW GW 392

ϕ ESTERNO x SP. <i>EXTERNAL ϕ x THK.</i> mm	DN	ϕ INTERNO <i>INTERNAL ϕ</i> mm	MASSA <i>MASS</i> kg/m	CONTENUTO D'ACQUA <i>WATER VOLUME</i> l/m	STATO FORNITURA <i>SUPPLIED CONDITION</i>
12x1	10	10	0,309	0,079	Rotolo / Roll 25/50 m (R 220) o / or
15x1	12	13	0,393	0,133	
18x1	15	16	0,477	0,201	
22x1	20	20	0,589	0,314	Barra / Bar 5 m (R 250 - R 290)
28x1,5	25	25	1,115	0,491	Barra / Bar 5 m (R 250 - R 290)
35x1,5	32	32	1,410	0,804	Barra / Bar 5 m (R 290)
42x1,5	40	39	1,704	1,194	
54x2	50	50	2,918	1,963	

B 70 72

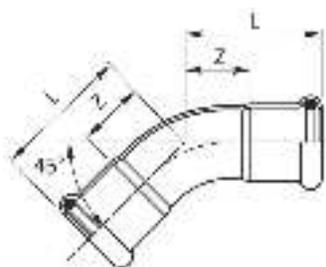
**681/450 G****CURVA 45° FF**

- 45° ELBOW FF
- BOGEN 45° II
- COUDE FF 45°
- CURVA 45° HH

MATERIAL: Cu-DHP99,9 - CW024A**O-RING:** NBR giallo - yellow - Gelb
jaune - amarillo

CODE	De mm	L mm	Z mm	 g		€
681015450G	15	27,5	7,5	36	4	-
681018450G	18	29,5	9,5	53	4	-
681022450G	22	32	11	71	4	-
681028450G	28	37	14	101	4	-
681035450G	35	43,5	17,5	138	1	-
681042450G	42	51	21	200	1	-
681054450G	54	62	26,5	306	1	-

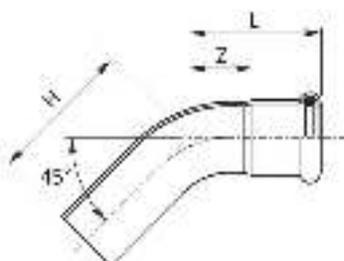
**681/451 G****CURVA 45° MF**

- 45° ELBOW MF
- BOGEN 45° IA
- COUDE MF 45°
- CURVA 45° HM

MATERIAL: Cu-DHP99,9 - CW024A**O-RING:** NBR giallo - yellow - Gelb
jaune - amarillo

B 70 72

CODE	De mm	L mm	H mm	Z mm	 g		€
681015451G	15	27,5	40	7,5	41	4	-
681018451G	18	29,5	36	9,5	50	4	-
681022451G	22	32	42	11	69	4	-
681028451G	28	37	46	14	99	4	-
681035451G	35	43,5	57,5	17,5	144	1	-
681042451G	42	51	72	21	215	1	-
681054451G	54	62	82	26,5	333	1	-

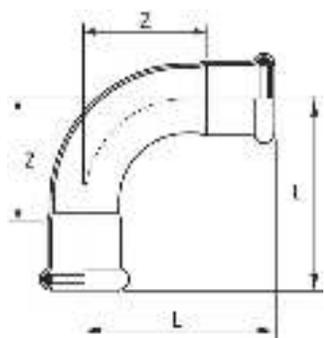

681/900 G
B 70 72
CURVA 90° FF

- 90° ELBOW FF
- BOGEN 90° II
- COUDE FF 90°
- CURVA 90° HH

MATERIAL: Cu-DHP99,9 - CW024A

O-RING: NBR giallo - yellow - Gelb
jaune - amarillo

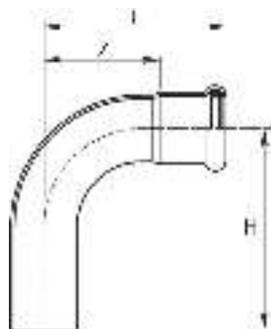
CODE	De mm	L mm	Z mm	 g		€
681015900G	15	38	18	51	4	-
681018900G	18	41,5	21,5	62	4	-
681022900G	22	47	26	88	4	-
681028900G	28	56	33	128	4	-
681035900G	35	68	42	180	1	-
681042900G	42	80	50	265	1	-
681054900G	54	100	64,5	419	1	-



681/901 G
B 70 72
CURVA 90° MF

- 90° ELBOW MF
- BOGEN 90° IA
- COUDE MF 90°
- CURVA 90° HM

MATERIAL: Cu-DHP99,9 - CW024A

O-RING: NBR giallo - yellow - Gelb
jaune - amarillo

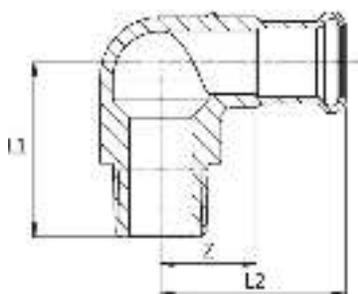
CODE	De mm	L mm	H mm	Z mm	 g		€
681015901G	15	38	48	18	49	4	-
681018901G	18	41,5	48,5	21,5	62	4	-
681022901G	22	47	57	26	87	4	-
681028901G	28	56	64	33	130	4	-
681035901G	35	68	82	42	195	1	-
681042901G	42	80	101	50	278	1	-
681054901G	54	100	120	64,5	435	1	-

**697 G****B 70 72****GOMITO MISTO 90° FILETTO M**

- ELBOW ADAPTER 90° WITH MALE THREAD
- ÜBERGANGSWINKEL 90° AG
- EQUERRE 90° AVEC FILETAGE M
- CODO MACHO

MATERIAL: CuSn5Zn5Pb2-C - CC499K**O-RING:** NBR giallo - yellow - Gelb
jaune - amarillo**THREAD:** EN 10226-1 (ex ISO 7/1)

CODE	De x R mm x inch	L1 mm	L2 mm	Z mm			€
697308015G	15 x 3/8"	35	41,5	21,5	86	4	-
697102015G	15 x 1/2"	38,5	41,5	21,5	131	4	-
697102018G	18 x 1/2"	40	42	22	136	4	-
697304018G	18 x 3/4"	44	42	22	177	4	-
697102022G	22 x 1/2"	42	42	21	162	4	-
697304022G	22 x 3/4"	47	42	21	193	4	-
697102028G	28 x 1/2"	45	47	24	199	4	-
697100028G	28 x 1"	53	45	24	318	4	-
697114035G	35 x 1"1/4	68	55	29	471	1	-
697112042G	42 x 1"1/2	75	65	35	660	1	-
697200054G*	54 x 2"	88	78	42	1078	1	-

[*] non certificato GASTEC QA - not certified GASTEC QA - keine Zertifizierung GASTEC QA - pas certifié GASTEC QA - GASTEC QA no certificado

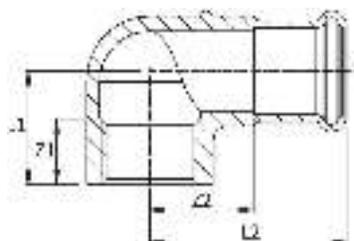
**698 G****B 70 72****GOMITO MISTO 90° FILETTO F**

- ELBOW ADAPTER 90° WITH FEMALE THREAD
- ÜBERGANGSWINKEL 90° IG
- EQUERRE 90° AVEC FILETAGE F
- CODO HEMBRA

MATERIAL: CuSn5Zn5Pb2-C - CC499K**O-RING:** NBR giallo - yellow - Gelb
jaune - amarillo**THREAD:** EN 10226-1 (ex ISO 7/1)

CODE	De x Rp mm x inch	L1 mm	L2 mm	Z1 mm	Z2 mm			€
698308015G	15 x 3/8"	22,5	41,5	12	21,5	87	4	-
698102015G	15 x 1/2"	22,5	41,5	16	21,5	102	4	-
698304015G	15 x 3/4"	25	41,5	16	21,5	125	4	-
698102018G	18 x 1/2"	24	42	16	22	112	4	-
698304018G	18 x 3/4"	26	42	16	22	133	4	-
698102022G	22 x 1/2"	26	42	15	21	129	4	-
698304022G	22 x 3/4"	29	42	16	21	152	4	-
698100022G	22 x 1"	32	45	19	24	203	4	-
698102028G	28 x 1/2"	29	47	16	24	168	4	-
698100028G	28 x 1"	35	48	19	25	240	4	-
698114035G	35 x 1"1/4	45	55	23	29	403	1	-
698112042G	42 x 1"1/2	52	65	23	35	541	1	-
698200054G*	54 x 2"	60	78	27	42	1085	1	-

[*] non certificato GASTEC QA - not certified GASTEC QA - keine Zertifizierung GASTEC QA - pas certifié GASTEC QA - GASTEC QA no certificado

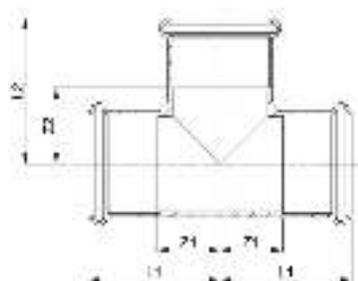
682 G
B 70 72
“T”

- EQUAL TEE
- T-STÜCK
- TÉ ÉGAL
- TE IGUAL HHH

MATERIAL: Cu-DHP99,9 - CW024A
O-RING: NBR giallo - yellow - Gelb
 jaune - amarillo

CODE	De mm	L1 mm	L2 mm	Z1 mm	Z2 mm	 g		€
682015000G	15	32	32	13,5	12	75	4	-
682018000G	18	34	34	13,5	14	96	4	-
682022000G	22	37	37	16	16	125	4	-
682028000G	28	42	42	19	19	174	4	-
682035000G	35	50	50	24	24	245	1	-
682042000G	42	57	63	27	33	345	1	-
682054000G	54	69	78	33,5	42	559	1	-

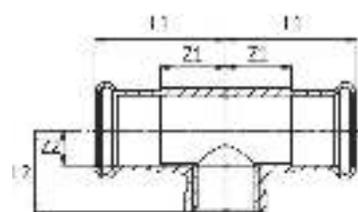

689 G
B 70 72
“T” CON DERIVAZIONE FILETTO F

- BRANCH TEE FEMALE BSP OUTLET
- T-STÜCK MIT ABGANG IG
- TÉ MIXTE AVEC FILETAGE F
- TE HEMBRA ROSCADA

MATERIAL: CuSn5Zn5Pb2-C - CC499K
O-RING: NBR giallo - yellow - Gelb
 jaune - amarillo
THREAD: EN 10226-1 (ex ISO 7/1)

CODE	De x Rp x De mm x inch x mm	L1 mm	L2 mm	Z1 mm	Z2 mm	 g		€
689308015G	15 x 3/8" x 15	41,5	22,5	21,5	10,5	118	4	-
689102015G	15 x 1/2" x 15	41,5	22,5	21,5	8,5	128	4	-
689102018G	18 x 1/2" x 18	42	24	22	10	145	4	-
689102022G	22 x 1/2" x 22	42	26	21	12	170	4	-
689304022G	22 x 3/4" x 22	42	30	21	14	183	4	-
689102028G	28 x 1/2" x 28	44	29	21	15	211	4	-
689304028G	28 x 3/4" x 28	44	30	21	14	216	4	-
689100028G	28 x 1" x 28	44	34	21	16	265	4	-
689102035G	35 x 1/2" x 35	50	34	24	19	308	1	-
689304035G	35 x 3/4" x 35	50	34	24	18	305	1	-
689100035G	35 x 1" x 35	50	35	24	17	329	1	-
689102042G	42 x 1/2" x 42	57	38	27	23	419	1	-
689304042G	42 x 3/4" x 42	57	38	27	22	415	1	-
689102054G*	54 x 1/2" x 54	69	44	33	30	638	1	-
689304054G*	54 x 3/4" x 54	69	44	33	28	639	1	-

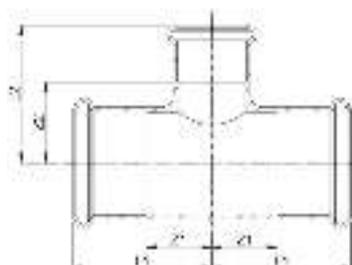
[*] non certificato GASTEC QA - not certified GASTEC QA - keine Zertifizierung GASTEC QA - pas certifié GASTEC QA - GASTEC QA no certificado

**692 G****B 70 72****"T" RIDOTTO**

- REDUCING TEE
- T-STÜCK MIT REDUZIERTEM ABGANG
- TÉ RÉDUIT
- TE REDUCIDA HHH

MATERIAL: Cu-DHP99,9 - CW024A**O-RING:** NBR giallo - yellow - Gelb
jaune - amarillo

CODE	De mm	L1 mm	L2 mm	Z1 mm	Z2 mm	 g		€
692018015G	18 x 15 x 18	34	35	14	15	93	4	-
692022015G	22 x 15 x 22	37	38	16	18	122	4	-
692022018G	22 x 18 x 22	37	38	16	18	128	4	-
692028015G	28 x 15 x 28	42	40,5	19	20,5	167	4	-
692028018G	28 x 18 x 28	42	40,5	19	20,5	168	4	-
692028022G	28 x 22 x 28	42	41	19	20	173	4	-
692035015G	35 x 15 x 35	50	44	24	24	250	1	-
692035018G	35 x 18 x 35	50	44	24	24	241	1	-
692035022G	35 x 22 x 35	50	44	24	23	237	1	-
692035028G	35 x 28 x 35	50	44	24	21	231	1	-
692042015G	42 x 15 x 42	57	47,5	27	27,5	338	1	-
692042018G	42 x 18 x 42	57	47,5	27	27,5	338	1	-
692042022G	42 x 22 x 42	57	53	27	32	330	1	-
692042028G	42 x 28 x 42	57	56	27	33	323	1	-
692042035G	42 x 35 x 42	57	61	27	35	338	1	-
692054022G	54 x 22 x 54	69	59	33,5	38	469	1	-
692054028G	54 x 28 x 54	69	64	33,5	41	465	1	-
692054035G	54 x 35 x 54	69	67	33,5	41	502	1	-
692054042G	54 x 42 x 54	69	70	33,5	40	489	1	-

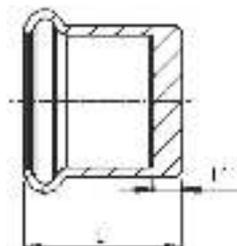
**683/003 G****B 70 72****TAPPO DI CHIUSURA**

- STOP END
- VERSCHLUSSKAPPE
- BOUCHON D'OBTURATION
- TAPÓN

MATERIAL: Cu-DHP99,9 - CW024A**O-RING:** NBR giallo - yellow - Gelb
jaune - amarillo

CODE	De mm	L mm	L1 mm	 g		€
683015003G	15	22,5	2,5	20	4	-
683018003G	18	23	3	25	4	-
683022003G	22	24,5	2,5	34	4	-
683028003G	28	26,5	3,5	49	4	-
683035003G	35	28,5	2,5	65	1	-
683042003G	42	32,5	2,5	93	1	-
683054003G	54	37,5	2,5	147	1	-

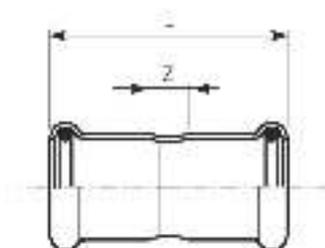

683/000 G
B7072
MANICOTTO

- COUPLING
- MUFFE
- MANCHON
- MANGUITO HH

MATERIAL: Cu-DHP99,9 - CW024A

O-RING: NBR giallo - yellow - Gelb
jaune - amarillo

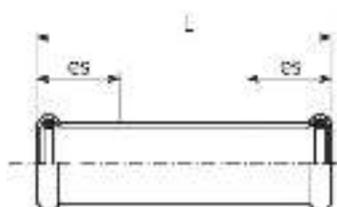
CODE	De mm	L mm	Z mm	 g		€
683015000G	15	49	9	39	4	-
683018000G	18	50	10	47	4	-
683022000G	22	53	11	62	4	-
683028000G	28	56	10	84	4	-
683035000G	35	63	10	108	1	-
683042000G	42	72	12	156	1	-
683054000G	54	83	13	225	1	-



683/001 G
B7072
MANICOTTO PASSANTE

- SLIP COUPLING
- SCHIEBEMUFFE
- MANCHON LONG
- MANGUITO SIN TOPE

MATERIAL: Cu-DHP99,9 - CW024A

O-RING: NBR giallo - yellow - Gelb
jaune - amarillo

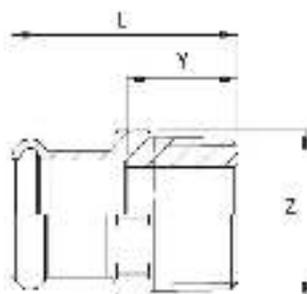
CODE	De mm	L mm	es mm	 g		€
683015001G	15	80	25	58	4	-
683018001G	18	80	25	66	4	-
683022001G	22	80	25	80	4	-
683028001G	28	90	30	110	4	-
683035001G	35	102	30	167	1	-
683042001G	42	120	40	223	1	-
683054001G	54	140	40	333	1	-

**687 G****B 70 72****MANICOTTO MISTO FILETTO M**

- MALE ADAPTER
- ÜBERGANGSSTÜCK MIT AG
- RACCORD AVEC FILETAGE MALE
- UNIÓN MACHO

MATERIAL: CuSn5Zn5Pb2-C - CC499K**O-RING:** NBR giallo - yellow - Gelb
jaune - amarillo**THREAD:** EN 10226-1 (ex ISO 7/1)

CODE	De x R mm x inch	L mm	Z mm	Y mm	 g		€
687308015G	15 x 3/8"	32	21	12	32	4	-
687102015G	15 x 1/2"	36	22	16	53	4	-
687304015G	15 x 3/4"	37,5	27	17,5	74	4	-
687102018G	18 x 1/2"	37	22	17	47	4	-
687304018G	18 x 3/4"	38	27	17	65	4	-
687102022G	22 x 1/2"	36	27	18	58	4	-
687304022G	22 x 3/4"	39	27	18	64	4	-
687100022G	22 x 1"	42,5	34	21,5	111	4	-
687304028G	28 x 3/4"	42	34	19	93	4	-
687100028G	28 x 1"	44,5	34	21,5	105	4	-
687114028G	28 x 1"1/4	48	43	25	192	4	-
687100035G	35 x 1"	48	40	22	139	1	-
687114035G	35 x 1"1/4	50	43	24	182	1	-
687112035G	35 x 1"1/2	51	50	25	239	1	-
687114042G	42 x 1"1/4	54	50	24	223	1	-
687112042G	42 x 1"1/2	54	50	24	215	1	-
687112054G*	54 x 1"1/2	60	63	24	316	1	-
687200054G*	54 x 2"	63,5	63	27,5	341	1	-

[*] non certificato GASTEC QA - not certified GASTEC QA - keine Zertifizierung GASTEC QA - pas certifié GASTEC QA - GASTEC QA no certificado

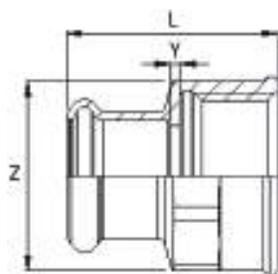
B7072

690 G
MANICOTTO MISTO FILETTO F

- FEMALE ADAPTER
- ÜBERGANGSSTÜCK MIT IG
- RACCORD AVEC FILETAGE FEMELLE
- UNIÓN HEMBRA

MATERIAL: CuSn5Zn5Pb2-C - CC499K

O-RING: NBR giallo - yellow - Gelb
jaune - amarillo

THREAD: EN 10226-1 (ex ISO 7/1)

CODE	De x Rp mm x inch	L mm	Z mm	Y mm	 g		€
690308015G	15 x 3/8"	33,5	21	2	38	4	-
690102015G	15 x 1/2"	36	26	2	58	4	-
690304015G	15 x 3/4"	39	31	2	76	4	-
690102018G	18 x 1/2"	37	26	2	61	4	-
690304018G	18 x 3/4"	39	31	2	77	4	-
690102022G	22 x 1/2"	36	27	1,5	64	4	-
690304022G	22 x 3/4"	39	31	2,5	76	4	-
690100022G	22 x 1"	42,5	38	2	112	4	-
690102028G	28 x 1/2"	39	34	1	98	4	-
690304028G	28 x 3/4"	41,5	34	2	98	4	-
690100028G	28 x 1"	45	38	2,5	122	4	-
690114028G	28 x 1"1/4	48	46	3	162	4	-
690100035G	35 x 1"	45	40	2	132	1	-
690114035G	35 x 1"1/4	50	46	2	164	1	-
690114042G	42 x 1"1/4	54	50	2	198	1	-
690112042G	42 x 1"1/2	54	53	2	217	1	-
690200054G*	54 x 2"	65	65	3	342	1	-

[*] non certificato GASTEC QA - not certified GASTEC QA - keine Zertifizierung GASTEC QA - pas certifié GASTEC QA - GASTEC QA no certificado

B 70 72

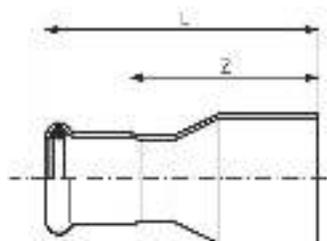
**691 G****RIDUZIONE MF**

- REDUCER
- REDUZIERSTÜCK
- REDUCTION
- REDUCCIÓN MH

MATERIAL: Cu-DHP99,9 - CW024A**O-RING:** NBR giallo - yellow - Gelb
jaune - amarillo

CODE	De mm	L mm	Z mm			€
691018015G	18 x 15	57	37	42	4	-
691022015G	22 x 15	64	44	53	4	-
691022018G	22 x 18	59,5	39,5	52	4	-
691028015G	28 x 15	54	34	48	4	-
691028018G	28 x 18	53	33	54	4	-
691028022G	28 x 22	65	44	72	4	-
691035022G	35 x 22	59	38	68	1	-
691035028G	35 x 28	71	48	98	1	-
691042022G	42 x 22	66	45	97	1	-
691042028G	42 x 28	65	42	99	1	-
691042035G	42 x 35	80,5	54,5	137	1	-
691054022G	54 x 22	74	53	154	1	-
691054028G	54 x 28	70	47	148	1	-
691054035G	54 x 35	76	50	159	1	-
691054042G	54 x 42	97,5	67,5	204	1	-

B 70 72

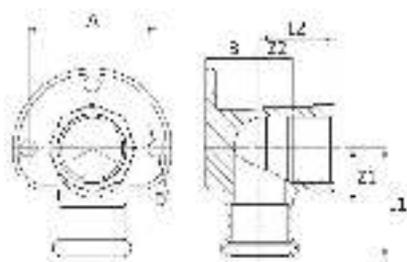
**685 G****GOMITO MISTO 90° FF**

- WALL PLATE ELBOW 90° WITH FEMALE THREAD
- DECKENWINKEL 90° IG
- EQUERRE 90° FF
- CODO PLACA

MATERIAL: CuSn5Zn5Pb2-C - CC499K**O-RING:** NBR giallo - yellow - Gelb
jaune - amarillo**THREAD:** EN 10226-1 (ex ISO 7/1)

CODE	De x Rp mm x inch	L1 mm	L2 mm	Z1 mm	Z2 mm	A mm	B mm	D mm			€
685102015G	15 x 1/2"	41,5	22,5	21,5	7	40	14	6,5	172	4	-
685102018G	18 x 1/2"	42	24	22	9	40	15	6,5	188	4	-
685304022G	22 x 3/4"	42	29	21	13	50	21	6,5	247	4	-

Certificazioni / Certifications

		GIUNTI MECCANICI PER TUBOLATURE - MARINEPRES MECHANICAL JOINTS FOR PIPES - MARINEPRES	MAC - 067019CS/001 - 002	Ø 15 - 108 mm
		RACCORDI A PRESSARE IN CUPRONICHEL / CUPRONICKEL PRESSFITTINGS PRODOTTI E COMPONENTI UTILIZZATI A CONTATTO CON ACQUA POTABILE PRODUCT AND ELEMENTS IN CONTACT WITH DRINKING WATER	ICIM-CAP-009671-00	Ø 15 - 108 mm
		TUBE FITTINGS - MARINEPRES	TAP000007B	Ø 15 - 108 mm
		PRESS FIT SYSTEM OF COMPRESSION TYPE FOR PIPING SYSTEMS	15/20055 (E1)	Ø 15 - 108 mm
		MARINEPRES PIPE PENETRATION (STANDARD FIRE TEST) Ø 15-108 MM	MED 1650183	Ø 15 - 108 mm
		PIPE COUPLING WITH O-RING SEAL MARINEPRES SYSTEM	38059/A0 BV	Ø 15 - 108 mm
		MARINEPRES, PIPING SYSTEM AND FITTING	19-GE1920312-PDA	Ø 15 - 108 mm
		MARINEPRES, MECHANICAL JOINTS	ML 20PTB00014	Ø 15 - 108 mm
		MARINEPRES PRESSFITTING SYSTEM	POCC IT.AM05.H05079	Ø 15 - 108 mm

Campi di applicazione / Fields of application

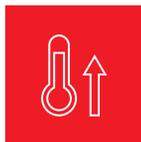

Riscaldamento
Heating



Raffrescamento
Cooling



Solare termico
Solar thermal



Aria compressa
Compressed air



Antincendio
Fire protection systems

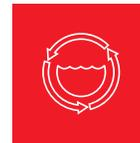

Acque di processo
Process water



Scarichi
Waste water

MARINE PRES® O-ring FKM

Verde | Green | Grün | Vert | Verde



**616/000 CN**
≤54 B 90 91
76÷108 B 90 92
PER IMPIANTI NAVALI

- FOR SHIPYARD SECTOR
- FÜR SCHIFFSBEREICH
- POUR SECTEUR NAVAL
- PARA SECTOR NAVAL

NORM: DIN 86019**Mat. Nr.: CuNi10Fe1.6Mn L=6 m**

CODE	Dimensions mm x mm	Ø int mm	L m	 kg/m	Volume l/m	Minimum package m	€/m
616015000CN	15 x 1,0	13	6	0,39	0,133	60	-
616018000CN	18 x 1,0	16	6	0,48	0,201	60	-
616022000CN	22 x 1,0	20	6	0,59	0,314	60	-
616028000CN	28 x 1,5	25	6	1,12	0,491	30	-
616035000CN	35 x 1,5	32	6	1,41	0,804	30	-
616042000CN	42 x 1,5	39	6	1,71	1,194	30	-
616054000CN	54 x 1,5	51	6	2,21	2,042	30	-
616076000CN	76,1 x 2,0	72,1	6	4,16	4,08	6	-
616088000CN	88,9 x 2,0	84,9	6	4,88	5,66	6	-
616108000CN	108 x 2,5	103	6	7,41	8,332	6	-

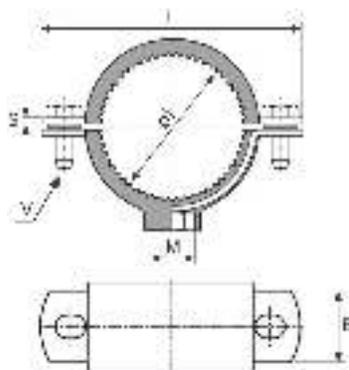
 Conforme a
 Conform to
 Entsprechend
 Correspondant
 Conforme a la
DIN 4109**156/G****A 50 50****COLLARE GOMMA PER TUBO MARINEPRES**

- CLAMP WITH RUBBER FOR MARINEPRES PIPE
- ROHRSCHELLE MIT GUMMIEINLAGE FÜR MARINEPRES ROHR
- COLLIER DE FIXATION GARNITURE ISOPHONIQUE POUR TUBE MARINEPRES
- ABRAZADERA ISOFÓNICA PARA TUBO MARINEPRES

MATERIAL: AISI 304 - 1.4301**VULCANIZED RUBBER:**
 EPDM [-20°
 C/+120° C]
 durezza/hardness
 55 Shore
NOTE: dado saldato con puntatura elettrica spot welded nut

CODE	Øi mm	M	V mm	B mm	L mm	S mm	 kg		€
156150304G	15 - 18	M 8	M 6 x 20	20	58	2,5	72	50*	-
156308304G	16 - 18	M 8	M 6 x 20	20	58	2,5	76	50*	-
156102304G	20 - 24	M 8	M 6 x 20	20	63,5	2,5	86	50*	-
156304304G	25 - 28	M 8	M 6 x 20	20	70	2,5	94	50*	-
156100304G	31 - 35	M 8	M 6 x 20	20	79	2,5	112	50*	-
156114304G	39 - 43	M 8	M 6 x 20	20	85	2,5	120	50*	-
156112304G	47 - 54	M 8	M 6 x 25	20	97	2,5	142	50*	-
156212304G	73 - 76,5	M 10	M 6 x 25	30	128	2,5	308	10*	-
156300304G	86 - 89	M 10	M 6 x 25	30	148	2,5	346	10*	-
156108316G **	108	M 8 / 10	M 6 x 25	20	168	2	200	10*	-

[*] unità minima di vendita / minimum selling quantity

 [**] Gomma staccabile - Detachable rubber - Abnehmbare Gummi - Caoutchouc amovible - Goma desmontable
 AISI 316 / 1.4401 (famiglia / family A 50 51)

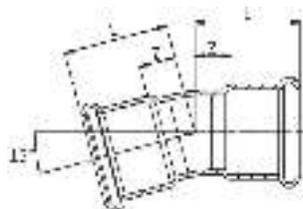

681/150 CN

≤54 B 80 81
76÷108 B 80 82

CURVA 15° FF

- 15° ELBOW FF
- BOGEN 15° II
- COUDE FF 15°
- CURVA 15° HH

MATERIAL: CuNi10Fe1.6Mn

O-RING: FKM verde - green - Grün
vert - verde

CODE	De mm	L mm	Z mm	 g			€
681015150CN	15	30	10	43	20	300	-
681022150CN	22	33	12	72	20	100	-
681028150CN	28	36	13	97	10	100	-
681035150CN	35	37	11	140	10	60	-
681042150CN	42	42	12	200	4	40	-
681054150CN	54	49	13	302	2	20	-
681076150CNC	76,1	87,5	32,5	863	2	2	-
681088150CNC	88,9	100,5	40,5	1147	2	2	-
681108150CNC	108	109,5	34,5	1567	2	2	-

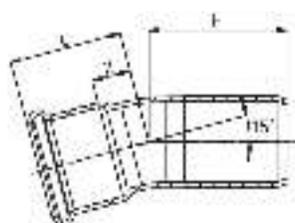

681/151 CN

≤54 B 80 81
76÷108 B 80 82

CURVA 15° MF

- 15° ELBOW MF
- BOGEN 15° IA
- COUDE MF 15°
- CURVA 15° HM

MATERIAL: CuNi10Fe1.6Mn

O-RING: FKM verde - green - Grün
vert - verde

CODE	De mm	L mm	H mm	Z mm	 g			€
681015151CN	15	30	40	10	42	20	300	-
681022151CN	22	33	41	12	71	20	100	-
681028151CN	28	36	43	13	101	10	100	-
681035151CN	35	37	41	11	148	10	60	-
681042151CN	42	42	55,5	12	183	4	40	-
681054151CN	54	49	55	13	339	2	20	-
681076151CNC	76,1	87,5	95,5	32,5	827	2	2	-
681088151CNC	88,9	100,5	108,5	40,5	1100	2	2	-
681108151CNC	108	109,5	118	34,5	1482	2	2	-

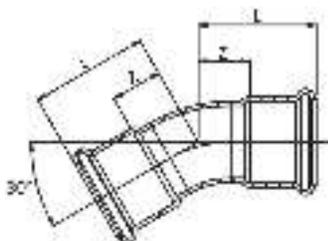
**681/300 CN**

≤54 B 80 81

76÷108 B 80 82

CURVA 30° FF

- 30° ELBOW FF
- BOGEN 30° II
- COUDE FF 30°
- CURVA 30° HH

MATERIAL: CuNi10Fe1.6Mn**O-RING:** FKM verde - green - Grün
vert - verde

CODE	De mm	L mm	Z mm				€
681015300CN	15	33	13	43	20	300	-
681022300CN	22	37	16	72	20	100	-
681028300CN	28	41	18	97	10	100	-
681035300CN	35	37	11	140	10	60	-
681042300CN	42	44	14	200	4	40	-
681054300CN	54	52	17	302	2	20	-
681076300CN	76,1	100	55	1004	2	2	-
681088300CN	88,9	115	64	1394	2	2	-
681108300CN	108	127	68	1896	2	2	-

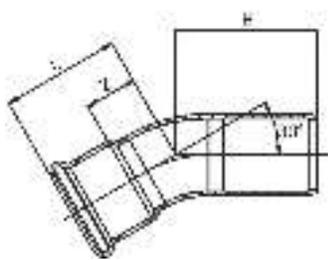
**681/301 CN**

≤54 B 80 81

76÷108 B 80 82

CURVA 30° MF

- 30° ELBOW MF
- BOGEN 30° IA
- COUDE MF 30°
- CURVA 30° HM

MATERIAL: CuNi10Fe1.6Mn**O-RING:** FKM verde - green - Grün
vert - verde

CODE	De mm	L mm	H mm	Z mm				€
681015301CN	15	33	43	13	42	20	300	-
681022301CN	22	37	46	16	71	20	100	-
681028301CN	28	41	48	18	101	10	100	-
681035301CN	35	37	46	11	148	10	60	-
681042301CN	42	44	54	14	208	4	40	-
681054301CN	54	52	63	17	339	2	20	-
681076301CN	76,1	100	108	55	1004	2	2	-
681088301CN	88,9	115	123	64	1394	2	2	-
681108301CN	108	127	136	68	1896	2	2	-

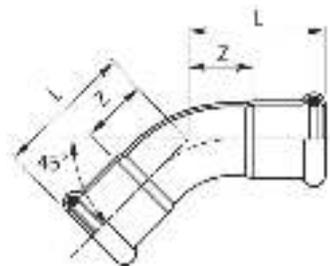

681/450 CN

≤54 B 80 81
76÷108 B 80 82

CURVA 45° FF

- 45° ELBOW FF
- BOGEN 45° II
- COUDE FF 45°
- CURVA 45° HH

MATERIAL: CuNi10Fe1.6Mn

O-RING: FKM verde - green - Grün
vert - verde

CODE	De mm	L mm	Z mm	g			€
681015450CN	15	27,5	7,5	43	20	300	-
681018450CN	18	29,5	9,5	54	20	300	-
681022450CN	22	32	11	72	20	100	-
681028450CN	28	37	14	97	10	100	-
681035450CN	35	43,5	17,5	140	10	60	-
681042450CN	42	51	21	200	4	40	-
681054450CN	54	62	26,5	302	2	20	-
681076450CN	76,1	133	78	1004	2	2	-
681088450CN	88,9	144,5	84,5	1394	2	2	-
681108450CN	108	169	94	1896	2	2	-

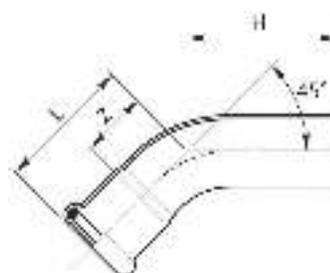

681/451 CN

≤54 B 80 81
76÷108 B 80 82

CURVA 45° MF

- 45° ELBOW MF
- BOGEN 45° IA
- COUDE MF 45°
- CURVA 45° HM

MATERIAL: CuNi10Fe1.6Mn

O-RING: FKM verde - green - Grün
vert - verde

CODE	De mm	L mm	H mm	Z mm	g		€	
681015451CN	15	27,5	39,5	7,5	42	20	300	-
681018451CN	18	29,5	36	9,5	54	20	300	-
681022451CN	22	32	42	11	71	20	100	-
681028451CN	28	37	46	14	101	10	100	-
681035451CN	35	43,5	57,5	17,5	148	10	60	-
681042451CN	42	51	72	21	208	4	40	-
681054451CN	54	62	82	26,5	339	2	20	-
681076451CN	76,1	133	149	78	1004	2	2	-
681088451CN	88,9	144,5	159,5	84,5	1394	2	2	-
681108451CN	108	169	184	94	1896	2	2	-

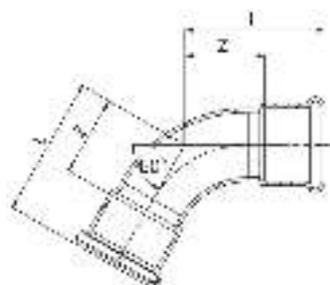
**681/600 CN**

≤54 B 80 81

76÷108 B 80 82

CURVA 60° FF

- 60° ELBOW FF
- BOGEN 60° II
- COUDE FF 60°
- CURVA 60° HH

MATERIAL: CuNi10Fe1.6Mn**O-RING:** FKM verde - green - Grün
vert - verde

CODE	De mm	L mm	Z mm				€
681028600CN	28	42	19	109	10	50	-
681035600CN	35	71	44	140	5	50	-
681042600CN	42	82	50	200	2	30	-
681054600CN	54	82	44	348	2	18	-
681076600CN	76,1	146,5	91,5	1311	2	2	-
681088600CN	88,9	162	102	1687	2	2	-
681108600CN	108	1190	115	2440	2	2	-

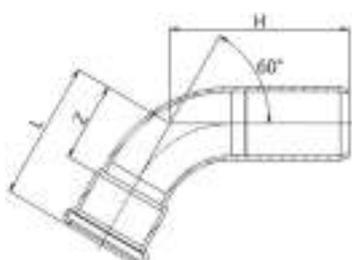
**681/601 CN**

≤54 B 80 81

76÷108 B 80 82

CURVA 60° MF

- 60° ELBOW MF
- BOGEN 60° IA
- COUDE MF 60°
- CURVA 60° HM

MATERIAL: CuNi10Fe1.6Mn**O-RING:** FKM verde - green - Grün
vert - verde

CODE	De mm	L mm	H mm	Z mm				€
681035601CN	35	71	74	50	148	5	50	-
681042601CN	42	82	86	50	208	2	30	-
681054601CN	54	82	89	45	339	2	18	-
681076601CN	76,1	146,5	164	91,5	1313	2	2	-
681088601CN	88,9	162	177	102	1674	2	2	-
681108601CN	108	190	205	115	2392	2	2	-

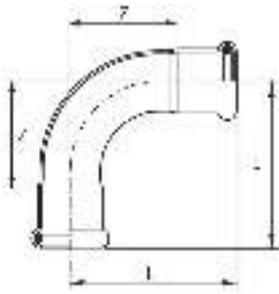

681/900 CN

≤54 B 80 81

76÷108 B 80 82

CURVA 90° FF

- 90° ELBOW FF
- BOGEN 90° II
- COUDE FF 90°
- CURVA 90° HH

MATERIAL: CuNi10Fe1.6Mn

O-RING: FKM verde - green - Grün
vert - verde

CODE	De mm	L mm	Z mm				€
681015900CN	15	38	18	51	20	300	-
681018900CN	18	41,5	21,5	64	20	200	-
681022900CN	22	47	26	88	10	100	-
681028900CN	28	56	33	124	10	50	-
681035900CN	35	68	42	185	5	50	-
681042900CN	42	80	50	253	2	30	-
681054900CN	54	100	65	427	2	18	-
681076900CN	76,1	160	105	1283	2	2	-
681088900CN	88,9	182	122	1762	2	2	-
681108900CN	108	220	145	2509	2	2	-

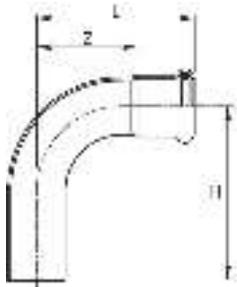

681/901 CN

≤54 B 80 81

76÷108 B 80 82

CURVA 90° MF

- 90° ELBOW MF
- BOGEN 90° IA
- COUDE MF 90°
- CURVA 90° HM

MATERIAL: CuNi10Fe1.6Mn

O-RING: FKM verde - green - Grün
vert - verde

CODE	De mm	L mm	H mm	Z mm				€
681015901CN	15	38	48	18	51	20	300	-
681018901CN	18	41,5	48,5	21,5	64	20	200	-
681022901CN	22	47	57	26	88	10	100	-
681028901CN	28	56	64	33	124	10	50	-
681035901CN	35	68	82	42	191	5	50	-
681042901CN	42	80	101	50	268	2	30	-
681054901CN	54	100	120	65	422	2	18	-
681076901CN	76,1	160	177	105	1283	2	2	-
681088901CN	88,9	182	197	122	1762	2	2	-
681108901CN	108	220	233	145	2509	2	2	-

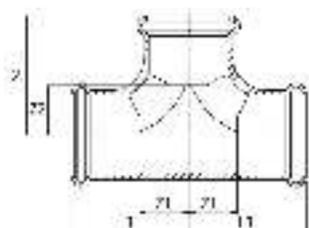
**682 CN**

≤54 B 80 81

76÷108 B 80 82

"T"

- EQUAL TEE
- T-STÜCK
- TÉ ÉGAL
- TE IGUAL HHH

MATERIAL: CuNi10Fe1.6Mn**O-RING:** FKM verde - green - Grün
vert - verde

CODE	De mm	L1 mm	L2 mm	Z1 mm	Z2 mm				€
682015000CN*	15	32	32	10,5	10,5	77	20	200	-
682018000CN*	18	34	34	12,5	12,5	95	20	100	-
682022000CN*	22	37	37	14,5	14,5	124	10	100	-
682028000CN*	28	42	42	17,5	17,5	175	10	50	-
682035000CN*	35	50	50	22,5	22,5	252	4	32	-
682042000CN*	42	57	57	25,5	25,5	343	4	20	-
682054000CN*	54	69	69	32,5	32,5	520	2	12	-
682076000CN	76,1	108	117,5	53	62,5	1422	2	2	-
682088000CN	88,9	131,5	134,5	71,5	71,5	1712	2	2	-
682108000CN	108	155	160	80	85	2359	2	2	-

(*) idroformato - hydroformed - hydrogeformt - hydroformé - hidroformado

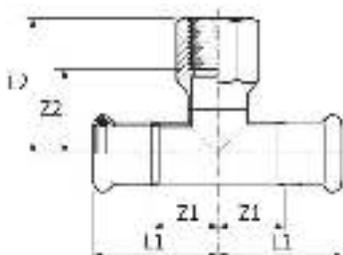
**689 CN**

≤54 B 80 81

76÷108 B 80 82

**"T" CON
DERIVAZIONE FILETTO F**

- BRANCH TEE FEMALE BSP OUTLET
- T-STÜCK MIT ABGANG IG
- TÉ MIXTE AVEC FILETAGE F
- TE HEMBRA ROSCADA

MATERIAL: CuNi10Fe1.6Mn**O-RING:** FKM verde - green - Grün
vert - verde**THREAD:** EN 10226-1 (ex ISO 7/1)

CODE	De x Rp x De mm x inch x mm	L1 mm	L2 mm	Z1 mm	Z2 mm				€
689102015CN	15 x 1/2" x 15	34,5	40	13,5	25	100	20	100	-
689102018CN	18 x 1/2" x 18	36,5	41,5	16,5	26,5	121	20	100	-
689102022CN	22 x 1/2" x 22	39,5	44	18	29	154	10	100	-
689304022CN	22 x 3/4" x 22	39,5	47	18	30,5	159	10	100	-
689102028CN	28 x 1/2" x 28	44	46,5	21	31,5	188	10	50	-
689304028CN	28 x 3/4" x 28	44	49,5	21	33	206	10	50	-
689102035CN	35 x 1/2" x 35	51	50	25,5	35	220	5	50	-
689304035CN	35 x 3/4" x 35	51	53	25,5	36,5	229	5	40	-
689102042CN	42 x 1/2" x 42	58,5	54	28,5	39	302	4	32	-
689304042CN	42 x 3/4" x 42	58,5	56,5	28,5	40	309	4	32	-
689102054CN	54 x 1/2" x 54	69,5	61	34	46	420	2	14	-
689304054CN	54 x 3/4" x 54	69,5	64	34	47,5	436	2	14	-
689304076CN	76,1 x 3/4" x 76,1	108	76	53	59,5	1160	2	2	-
689304088CN	88,9 x 3/4" x 88,9	131,5	83,5	71,5	67	1400	2	2	-
689304108CN	108 x 3/4" x 108	155	93	80	76,5	1896	2	2	-

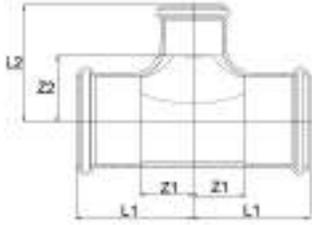

692 CN

≤54 B 80 81

76÷108 B 80 82

“T” RIDOTTO

- REDUCING TEE
- T-STÜCK MIT REDUZIERTEM ABGANG
- TÉ RÉDUIT
- TE REDUCIDA HHH

MATERIAL: CuNi10Fe1.6Mn

O-RING: FKM verde - green - Grün
vert - verde

CODE	De mm	L1 mm	L2 mm	Z1 mm	Z2 mm	 g			€
692018015CN*	18 x 15 x 18	34	35	12,5	13,5	89	20	100	-
692022015CN*	22 x 15 x 22	37	38	16	18	118	10	100	-
692028015CN*	28 x 15 x 28	42	40,5	17,5	19	157	10	50	-
692028018CN*	28 x 18 x 28	42	40,5	17,5	19	162	10	50	-
692028022CN*	28 x 22 x 28	42	41	17,5	20	166	10	50	-
692035015CN	35 x 15 x 35	51	49	25	29	176	5	50	-
692035022CN	35 x 22 x 35	51	50,5	25	29,5	186	5	50	-
692035028CN	35 x 28 x 35	51	53,5	25	30,5	191	5	35	-
692042022CN	42 x 22 x 42	58,5	54	28	33	264	4	20	-
692042028CN	42 x 28 x 42	58,5	57	28	34	261	4	20	-
692042035CN	42 x 35 x 42	58,5	61	28	35	303	4	20	-
692054022CN	54 x 22 x 54	69,5	61,5	34	40,5	368	2	16	-
692054028CN	54 x 28 x 54	69,5	65,5	34	41,5	385	2	16	-
692054035CN	54 x 35 x 54	69,5	68,5	34	42,5	403	2	16	-
692054042CN	54 x 42 x 54	69,5	72	34	42	419	2	16	-
692076022CN	76,1 x 22 x 76,1	108	72,5	52	52,5	1110	2	2	-
692076028CN	76,1 x 28 x 76,1	108	77	52	54	1132	2	2	-
692076035CN	76,1 x 35 x 76,1	108	80	52	54	1143	2	2	-
692076042CN	76,1 x 42 x 76,1	108	84	52	54	1165	2	2	-
692076054CN	76,1 x 54 x 76,1	108	90	52	55	1188	2	2	-
692088022CN	88,9 x 22 x 88,9	132	81	72	60	1361	2	2	-
692088028CN	88,9 x 28 x 88,9	132	84	72	61	1366	2	2	-
692088035CN	88,9 x 35 x 88,9	132	88	72	62	1389	2	2	-
692088042CN	88,9 x 42 x 88,9	132	91	72	61	1400	2	2	-
692088054CN	88,9 x 54 x 88,9	132	97	72	62	1428	2	2	-
692088076CN	88,9 x 76 x 88,9	132	125	72	70	1656	2	2	-
692108022CN	108 x 22 x 108	155	91	74	70	1857	2	2	-
692108028CN	108 x 28 x 108	155	94	74	71	1863	2	2	-
692108035CN	108 x 35 x 108	155	97	74	71	1980	2	2	-
692108042CN	108 x 42 x 108	155	101	74	71	2080	2	2	-
692108054CN	108 x 54 x 108	155	107	74	72	2147	2	2	-
692108076CN	108 x 76,1 x 108	155	135	74	80	2153	2	2	-
692108088CN	108 x 88,9 x 108	155	141	74	81	2192	2	2	-

[*] idroformato - hydroformed - hydrogeformt - hydroformé - hidroformado

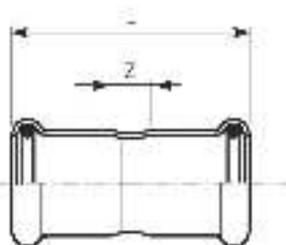
**683/000 CN**

≤54 B 80 81

76÷108 B 80 82

MANICOTTO

- COUPLING
- MUFFE
- MANCHON
- MANGUITO HH

MATERIAL: CuNi10Fe1.6Mn**O-RING:** FKM verde - green - Grün
vert - verde

CODE	De mm	L mm	Z mm				€
683015000CN	15	49	9	39	20	500	-
683018000CN	18	50	10	47	20	300	-
683022000CN	22	52,5	10,5	60	20	200	-
683028000CN	28	56	10	79	10	150	-
683035000CN	35	62,5	10,5	108	10	100	-
683042000CN	42	72	12	152	4	60	-
683054000CN	54	83	12	221	2	24	-
683076000CN	76,1	142	32	708	4	4	-
683088000CN	88,9	165,5	45,5	853	4	4	-
683108000CN	108	203	53	1305	2	2	-

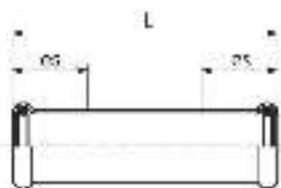
**683/001 CN**

≤54 B 80 81

76÷108 B 80 82

**MANICOTTO
PASSANTE**

- SLIP COUPLING
- SCHIEBEMUFFE
- MANCHON LONG
- MANGUITO SIN TOPE

MATERIAL: CuNi10Fe1.6Mn**O-RING:** FKM verde - green - Grün
vert - verde

CODE	De mm	L mm	es mm				€
683015001CN	15	67,5	25	54	20	200	-
683018001CN	18	71	25	66	20	200	-
683022001CN	22	77	25	86	10	100	-
683028001CN	28	88	30	123	10	50	-
683035001CN	35	101,5	30	171	4	40	-
683042001CN	42	117	40	243	2	40	-
683054001CN	54	138	40	358	2	20	-
683076001CN	76,1	225	60	1105	2	2	-
683088001CN	88,9	258	70	1468	2	2	-
683108001CN	108	305	80	2135	2	2	-

B 80 81

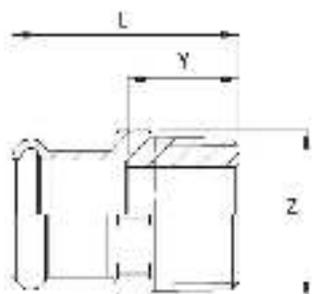

687 CN

MANICOTTO MISTO FILETTO M

- MALE ADAPTER
- ÜBERGANGSSTÜCK MIT AG
- RACCORD AVEC FILETAGE MALE
- UNIÓN MACHO

MATERIAL: CuNi10Fe1.6Mn
O-RING: FKM verde - green - Grün
 vert - verde
THREAD: EN 10226-1 (ex ISO 7/1)

CODE	De x R mm x inch	L mm	Z mm	Y mm	g			€
687102015CN	15 x 1/2"	36	24	16	58	20	300	-
687102018CN	18 x 1/2"	37	27	17	58	20	300	-
687304018CN	18 x 3/4"	38	30	18	73	20	200	-
687102022CN	22 x 1/2"	38	32	17	72	10	200	-
687304022CN	22 x 3/4"	39	32	18	80	10	200	-
687100028CN	28 x 1"	44,5	38	21,5	121	10	100	-
687114035CN	35 x 1 1/4"	50	46	24	199	5	50	-
687112042CN	42 x 1 1/2"	54	54	24	244	4	40	-
687200054CN	54 x 2"	63,5	70	27,5	406	4	32	-

B 80 81

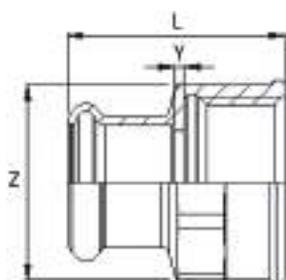

690 CN

MANICOTTO MISTO FILETTO F

- FEMALE ADAPTER
- ÜBERGANGSSTÜCK MIT IG
- RACCORD AVEC FILETAGE FEMELLE
- UNIÓN HEMBRA

MATERIAL: CuNi10Fe1.6Mn
O-RING: FKM verde - green - Grün
 vert - verde
THREAD: EN 10226-1 (ex ISO 7/1)

CODE	De x Rp mm x inch	L mm	Z mm	Y mm	g			€
690102015CN	15 x 1/2"	36	30	2	70	20	300	-
690102018CN	18 x 1/2"	37	30	2	74	20	300	-
690304018CN	18 x 3/4"	39	34	2	90	10	200	-
690102022CN	22 x 1/2"	36	32	1	80	20	200	-
690304022CN	22 x 3/4"	39	34	1,5	87	10	100	-
690102028CN	28 x 1/2"	39	38	1	115	10	100	-
690100028CN	28 x 1"	45	43	2,5	148	10	100	-
690114035CN	35 x 1 1/4"	50	50	2	192	5	50	-
690112042CN	42 x 1 1/2"	54	60	2	272	4	40	-
690200054CN	54 x 2"	65	70	3	399	4	20	-

B 80 81

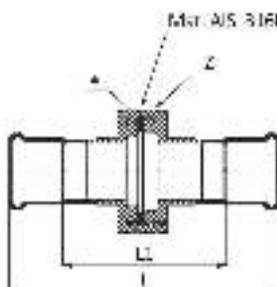
**684/001 CN****BOCCHETTONE A SEDE PIANA**

- FLAT FACED UNION
- DURCHGANGSVERSCHRAUBUNG MIT PRESSENDEN FLACHDICHTEND
- ÉLÉMENT DE TRANSITION FILTÉ PLAT AVEC MANCHONS DES 2 CÔTES
- RÁCOR 3 PIEZAS PLANO

MATERIAL: CuNi10Fe1.6Mn**O-RING:** FKM verde - green - Grün
vert - verde**GASKET:** [*]: FKM verde - green - Grün
vert - verde

CODE	De mm	L mm	L1 mm	Z mm	Gasket mm				€
684015001CN	15	96	56	18	24x14 thk 3	146	10	100	-
684018001CN	18	97	57	20	30x20 thk 3	187	10	100	-
684022001CN	22	100	58	24	30x20 thk 3	194	10	50	-
684028001CN	28	117	71	32	47,5x37 thk 3	450	5	25	-
684035001CN	35	127	75	41	56x42 thk 3	617	4	20	-
684042001CN	42	140	80	46	66x56 thk 3	797	2	20	-
684054001CN	54	152	82	60	79,5x69 thk 3	1176	2	10	-

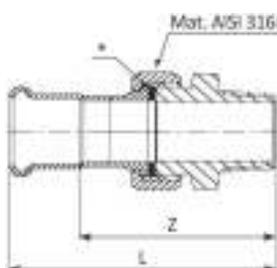
**684/002 CN****BOCCHETTONE SEDE PIANA FILETTO M**

- STRAIGHT MALE UNION CONNECTOR
- DURCHGANGSVERSCHRAUBUNG MIT AUSSENGEWINDE
- RACCORD UNION FILETÉ
- RÁCOR 3 PIEZAS ROSCADO MACHO

MATERIAL: CuNi10Fe1.6Mn**O-RING:** FKM verde - green - Grün
vert - verde**GASKET:** [*]: FKM verde - green - Grün
vert - verde**THREAD:** EN 10226-1 (ex ISO 7/1)

CODE	De x R mm x inch	L mm	Z mm	Gasket mm				€
684015002CN	15 x 1/2"	76	56	24x14 thk 3	142	2	160	-
684018002CN	18 x 1/2"	76	56	24x14 thk 3	144	2	160	-
684022002CN	22 x 3/4"	80	59	30x20 thk 3	202	2	100	-
684028002CN	28 x 1"	90	67	39x27 thk 3	364	2	60	-
684035002CN	35 x 1 1/4"	100	74	44,5x34 thk 3	540	2	40	-
684042002CN	42 x 1 1/2"	104	74	50,5x40 thk 3	563	2	30	-
684054002CN	54 x 2"	118	83	65,5x53,5 thk 3	823	2	20	-

B 80 81

684/003 CN

BOCCHETTONE SEDE PIANA FILETTO F

- STRAIGHT FEMALE UNION CONNECTOR
- DURCHGANGSVerschraubung MIT INNENGEWINDE
- RACCORD UNION TARAUDÉ
- RÁCOR 3 PIEZAS HEMBRA

MATERIAL: CuNi10Fe1.6Mn

O-RING: FKM verde - green - Grün
vert - verde

GASKET: [*]: FKM verde - green - Grün
vert - verde

THREAD: EN 10226-1 (ex ISO 7/1)

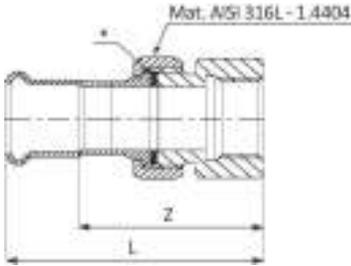

CODE	De x Rp mm x inch	L mm	Z mm	Gasket mm				€
684015003CN	15 x 1/2"	70	50	24x14 thk 3	140	2	160	-
684018003CN	18 x 1/2"	71	51	24x14 thk 3	145	2	140	-
684022003CN	22 x 3/4"	75	54	30x20 thk 3	213	2	100	-
684028003CN	28 x 1"	83	60	39x27 thk 3	404	2	60	-
684035003CN	35 x 1 1/4"	92	66	44,5x34 thk 3	486	2	30	-
684042003CN	42 x 1 1/2"	96	66	50,5x40 thk 3	536	2	30	-
684054003CN	54 x 2"	116	81	65,5x53,5 thk 3	1091	2	20	-

≤54 B 80 81

76÷108 B 80 82

691 CN

RIDUZIONE MF

- REDUCER
- REDUZIERSTÜCK
- REDUCTION
- REDUCCIÓN MH

MATERIAL: CuNi10Fe1.6Mn

O-RING: FKM verde - green - Grün
vert - verde

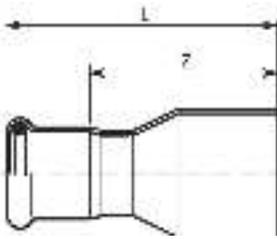

CODE	De mm	L mm	Z mm				€
691018015CN	18 x 15	57	37	43	20	500	-
691022015CN	22 x 15	64	44	54	20	400	-
691022018CN	22 x 18	60	40	54	20	300	-
691028015CN	28 x 15	76,5	56,5	73	20	200	-
691028022CN	28 x 22	65	44	74	20	200	-
691035022CN	35 x 22	70	49	91	10	100	-
691035028CN	35 x 28	71	48	101	10	100	-
691042022CN	42 x 22	97	76	140	4	80	-
691042028CN	42 x 28	93	70	145	4	80	-
691042035CN	42 x 35	81	55	139	4	40	-
691054028CN	54 x 28	108,5	85,5	204	4	40	-
691054035CN	54 x 35	108	82	215	4	40	-
691054042CN	54 x 42	97,5	67,5	216	4	32	-
691076042CN	76,1 x 42	141	111	489	4	4	-
691076054CN	76,1 x 54	158	123	593	4	4	-
691088054CN	88,9 x 54	176	141	763	4	4	-
691088076CN	88,9 x 76,1	184	129	902	4	4	-
691108054CN	108 x 54	204	168	1067	2	2	-
691108076CN	108 x 76,1	206	151	1126	2	2	-
691108088CN	108 x 88,9	207	147	1229	2	2	-

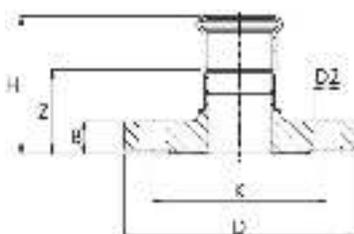
**693/002 CN**

≤54 B 80 81

76÷108 B 80 82

**MANICOTTO
FLANGIATO**

- ADAPTOR FLANGE
- ÜBERGANGSFLANSCH
- BRIDE DE RACCORDEMENT
- BRIDA ADAPTADOR

MATERIAL: CuNi10Fe1.6Mn**O-RING:** FKM verde - green - Grün
vert - verde**PN 6**

CODE	De mm	DN flg	H mm	Z mm	B mm	D mm	D2 mm	Holes Nr.	K mm				€
693015002CN	15	15	53	33	12	80	11	4	55	452	2	20	-
693018002CN	18	15	53,5	33,5	12	80	11	4	55	452	2	20	-
693022002CN	22	20	56,5	35,5	14	90	11	4	65	680	2	14	-
693028002CN	28	25	59,5	36,5	14	100	11	4	75	843	2	10	-
693035002CN	35	32	63	37	14	120	14	4	90	1206	2	6	-
693042002CN	42	40	67	37	14	130	14	4	100	1324	2	6	-
693054002CN	54	50	74	38	14	140	14	4	110	1505	2	4	-
693076002CN	76,1	65	101	45,5	14	160	14	4	130	2086	2	2	-
693088002CN	88,9	80	112	52	16	190	18	4	150	3253	2	2	-
693108002CN	108	100	128	53	16	210	18	4	170	3924	2	2	-

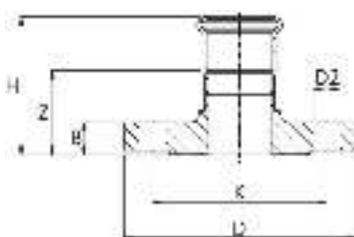
**693/000 CN**

≤54 B 80 81

76÷108 B 80 82

**MANICOTTO
FLANGIATO**

- ADAPTOR FLANGE
- ÜBERGANGSFLANSCH
- BRIDE DE RACCORDEMENT
- BRIDA ADAPTADOR

MATERIAL: CuNi10Fe1.6Mn**O-RING:** FKM verde - green - Grün
vert - verde**PN 16**

CODE	De mm	DN flg	H mm	Z mm	B mm	D mm	D2 mm	Holes Nr.	K mm				€
693015000CN	15	15	55	35	14	95	14	4	65	735	2	20	-
693018000CN	18	15	55,5	35,5	14	95	14	4	65	735	2	20	-
693022000CN	22	20	58,5	37,5	16	105	14	4	75	1051	2	14	-
693028000CN	28	25	61,5	38,5	16	115	14	4	85	1267	2	10	-
693035000CN	35	32	65,5	39,5	16	140	18	4	100	1828	2	6	-
693042000CN	42	40	69	39	16	150	18	4	110	2007	2	6	-
693054000CN	54	50	78	42	18	165	18	4	125	2734	2	4	-
693076000CN	76,1	65	105	50	18	185	18	4	145	3538	2	2	-
693088000CN	88,9	80	116	56	20	200	18	8	160	4382	2	2	-
693108000CN	108	100	132	57	20	220	18	8	180	5230	2	2	-



434/PN6

R 30 30

GUARNIZIONE ECOLOGICA PER FLANGE

- GASKET FOR FLANGE
- FLANSCHDICHTUNG
- JOINT POUR BRIDE
- JUNTA ECOLÓGICA PARA BRIDA

MATERIAL: Sesalit Eco

NORM: EN 1092-1

PN 6

CODE	DN	De mm	Di mm	S mm			€
434015006	15 - [1/2"]	44	20	2	4	10	-
434020006	20 - [3/4"]	54	25	2	6	10	-
434025006	25 - [1"]	64	30	2	9	10	-
434032006	32 - [1 1/4"]	75	38	2	11	10	-
434040006	40 - [1 1/2"]	85	45	2	14	10	-
434050006	50 - [2"]	95	57	2	15	10	-
434065006	65 - [2 1/2"]	115	76	2	19	10	-
434080006	80 - [3"]	132	89	2	26	10	-
434100006	100 - [4"]	152	108	2	29	10	-

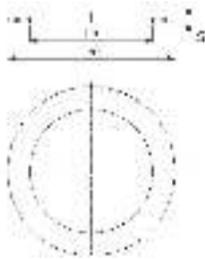

434/PN10-16

R 30 30

GUARNIZIONE ECOLOGICA PER FLANGE

- GASKET FOR FLANGE
- FLANSCHDICHTUNG
- JOINT POUR BRIDE
- JUNTA ECOLÓGICA PARA BRIDA

MATERIAL: Sesalit Eco

NORM: EN 1092-1

PN 10/16

CODE	DN	De mm	Di mm	S mm			€
434015000	15 - [1/2"]	50	20	2	6	10	-
434020000	20 - [3/4"]	60	25	2	8	10	-
434025000	25 - [1"]	70	30	2	10	10	-
434032000	32 - [1 1/4"]	82	38	2	14	10	-
434040000	40 - [1 1/2"]	92	45	2	17	10	-
434050000	50 - [2"]	108	57	2	22	10	-
434065000	65 - [2 1/2"]	127	76	2	27	10	-
434080000	80 - [3"]	142	89	2	30	10	-
434100000	100 - [4"]	162	108	2	38	10	-

Sesalit ECO: fibre organiche e sintetiche legate con gomma NBR/SBR esente amianto
IMPIEGHI: Acqua calda e fredda, olii vegetali ed animali, aria, alcuni carburanti (no GAS)

LIMITI DI TEMPERATURA ORIENTATIVI

Temperatura massima per brevi esposizioni: 180°-200° C
 Temperatura massima di esercizio continuo per fluidi non aggressivi: 140° C
 Temperatura massima di esercizio continuo con vapore: 110° C

OMOLOGAZIONI: acqua potabile WRAS n° 1605525

Sesalit ECO: organic and synthetic fibers bonded with NBR/SBR asbestos-free

USES: hot and cold water, vegetable and animal oils, air, some fuels (no GAS)

GUIDELINE TEMPERATURE LIMITS

Maximum temperature for short exposure: 180°-200° C
 Maximum operating temperature for continuous non-aggressive fluids: 140° C
 Maximum temperature for continuous operation with steam: 110° C

APPROVAL: potable water WRAS n° 1605525

**693/004 CN**

≤54 B 80 81

76÷108 B 80 82

BOCCELLO PER FLANGE LIBERE

- COLLAR FOR LOOSE FLANGES
- AUSSEN FÜR LOSE-FLANSCH
- SORTIE A BRIDE POUR BRIDE TOURNANTE
- TRONCO EMBRIDADO PARA BRIDA LOCA

MATERIAL: CuNi10Fe1.6Mn**PN 6**

CODE	De mm	L mm	D mm	D1 mm	D2 mm	H mm				€
693022004CN	22	135	50	27	22	5	160	1	14	-
693028004CN	28	135	60	32	28	5	260	1	14	-
693035004CN	35	135	70	40	35	5	340	1	14	-
693042004CN	42	135	80	46	42	6	450	1	14	-
693054004CN	54	135	90	59	54	6	560	1	14	-
693076004CN	76,1	135	110	78	76,1	6	850	1	12	-
693088004CN	88,9	135	128	91	88,9	7	1200	1	6	-
693108004CN	108	135	148	110	108	7	1540	1	2	-

**693/003 CN**

≤54 B 80 81

76÷108 B 80 82

BOCCELLO PER FLANGE LIBERE

- COLLAR FOR LOOSE FLANGES
- AUSSEN FÜR LOSE-FLANSCH
- SORTIE A BRIDE POUR BRIDE TOURNANTE
- TRONCO EMBRIDADO PARA BRIDA LOCA

MATERIAL: CuNi10Fe1.6Mn**PN 16**

CODE	De mm	L mm	D mm	D1 mm	D2 mm	H mm				€
693022003CN	22	135	58	27	22	5	190	1	14	-
693028003CN	28	135	68	32	28	5	300	1	14	-
693035003CN	35	135	78	40	35	5	380	1	14	-
693042003CN	42	135	88	46	42	6	510	1	14	-
693054003CN	54	135	102	59	54	6	650	1	14	-
693076003CN	76,1	135	122	78	76,1	6	970	1	4	-
693088003CN	88,9	135	138	91	88,9	7	1240	1	4	-
693108003CN	108	135	158	110	108	7	1690	1	2	-

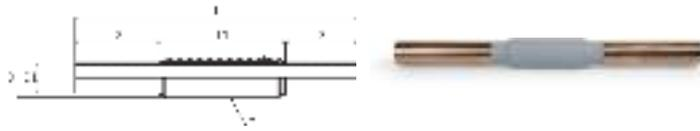

679/001 CN

≤54 B 80 81

76÷108 B 80 82

PASSAGGIO STAGNO

- DECK / BULKHEAD PENETRATION
- WANDDURCHFÜHRUNG
- PASSAGE ÉTANCHE
- PASAJE ESTAÑO

MATERIAL: CuNi10Fe1.6Mn

NOTE: [*]: S235JR (Fe 360)

CODE	De mm	L mm	L1 mm	Z mm	D mm	D1 mm	g	kg	box	€
679015001CN	15	450	120	165	25	15	513	1	65	-
679018001CN	18	450	120	165	30	18	693	1	65	-
679022001CN	22	450	120	165	33	22	782	1	50	-
679028001CN	28	450	120	165	37	28	865	1	45	-
679035001CN	35	450	120	165	43,5	35	1044	1	40	-
679042001CN	42	450	120	165	53	42	1440	1	30	-
679054001CN	54	450	120	165	69	54	2192	1	18	-
679076001CN	76,1	450	120	165	88,5	76,1	3167	1	8	-
679088001CN	88,9	450	120	165	107	88,9	4551	1	8	-
679108001CN	108	450	120	165	131,5	108	6337	1	6	-

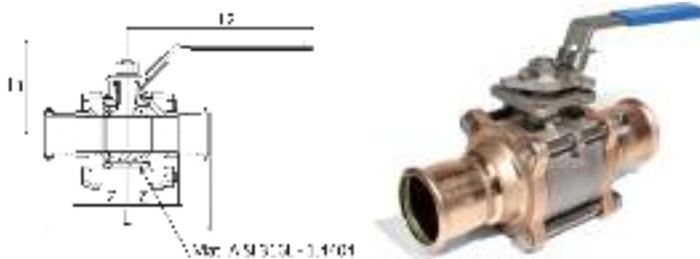

695/003 CN

≤54 B 80 81

76÷108 B 80 82

VALVOLA A SFERA 3 PZ PASSAGGIO TOTALE LUCCHETTABILE CON BASE PER ATTUATORE

- 3-PC BALL VALVE WITH FULL PORT
- KUGELHAHN 3-TEILIG MIT VOLLEM DURCHGANG
- BOISSEAU SPHERIQUE 3 PIECES PASSAGE INTÉGRAL
- VÁLVULA DE BOLA TRES PIEZAS POSO TOTAL

MATERIAL: CuNi10Fe1.6Mn (corpo/body AISI 316L - 1.4404)

O-RING: FKM verde - green - Grün
vert - verde

CODE	DN	De mm	DN inch	L mm	Z mm	L1 mm	L2 mm	g	kg	box	€
695015003CN	10	15	3/8"	122	41	72	151	726	1	10	-
695018003CN	15	18	1/2"	123	41,5	72	151	750	1	10	-
695022003CN	20	22	3/4"	127	42,5	80	151	1024	1	10	-
695028003CN	25	28	1"	145	49,5	90	179	1550	1	5	-
695035003CN	32	35	1" 1/4	170	59	95	179	2395	1	5	-
695042003CN	40	42	1" 1/2	197	68,5	104	198	3334	1	5	-
695054003CN	50	54	2"	220	75	110	198	4694	1	2	-
695076003CN	65	76,1	2" 1/2	308	99	150	270	9648	1	1	-
695088003CN	80	88,9	3"	362	121	159	270	13242	1	1	-
695108003CN	100	108	4"	422	136	210	405	26250	1	1	-

Le condizioni stampigliate sono relative al corpo della valvola. La pressione massima di lavoro delle valvole art. 695/003 CN = 16 bar. Con flangia per attuatore.

The marked pressure's conditions are related to the body of the valve. Maximum working pressure for pressfitting valve art. 695/003 CN = 16 bar. With flange for actuator.

Die markierte Konditionen der Pressfitting entsprechen den Kugelhahnkoerper. Maximaler Arbeitsbetriebsdruck für Kugelhahn 695/003 CN = 16 bar. Mit Flansch für Stellantrieb.

Les conditions de pressions indiquées sur la presse vannes correspondent au corps de vanne. Pression de service maximale des vannes 695/003 CN = 16 bar. Avec bride pour actuateur.

Condiciones de presión marcadas están relacionadas con el cuerpo de la válvula. La presión máxima de trabajo de las válvulas art. 695/003 CN = 16 bar. Con brida para actuador.

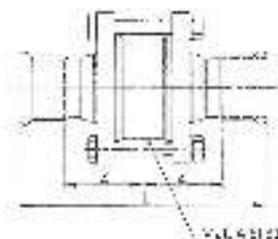
**695/004 CN**

≤54 B 80 81

76÷108 B 80 82

VALVOLA DI RITEGNO

- NON-RETURN VALVE
- RÜCKSCHLAGVENTIL
- CLAPET ANTI-RETOUR
- VÁLVULA DE RETENCIÓN

MATERIAL: CuNi10Fe1.6Mn (corpo/body AISI 316L - 1.4404)

O-RING: FKM verde - green - Grün
vert - verde

CODE	DN	De mm	L mm	Z mm				€
695015004CN	15	15	113	36,5	443	1	10	-
695018004CN	15	18	114	37	554	1	10	-
695022004CN	20	22	121	39,5	614	1	10	-
695028004CN	25	28	138	46	828	1	10	-
695035004CN	32	35	158	53	1324	1	10	-
695042004CN	40	42	180	60	1832	1	6	-
695054004CN	50	54	199	64,5	2676	1	2	-
695076004CN	65	76,1	269	79,5	5442	1	1	-
695088004CN	80	88,9	303	91,5	8466	1	1	-
695108004CN	100	108	370	110	14640	1	1	-

Le condizioni stampigliate sono relative al corpo della valvola. La pressione massima di lavoro delle valvole art. 695/004 CN = 16 bar

The marked pressure's conditions are related to the body of the valve. Maximum working pressure for pressfitting valve art. 695/004 CN = 16 bar

Die markierte Konditionen der Pressfitting entsprechend den Kugelhahnkoerper. Maximaler Arbeitsbetriebsdruck für Kugelhahn 695/004 CN = 16 bar

Les conditions de pressions indiquées sur la presse vannes correspondent au corps de vanne. Pression de service maximale des vannes 695/004 CN = 16 bar.

Condiciones de presión marcadas están relacionadas con el cuerpo de la válvula. La presión máxima de trabajo de las válvulas art. 695/004 CN = 16 bar

**DIAGRAMMA PERDITA DI CARICO
PRESSURE LOSS DIAGRAM**

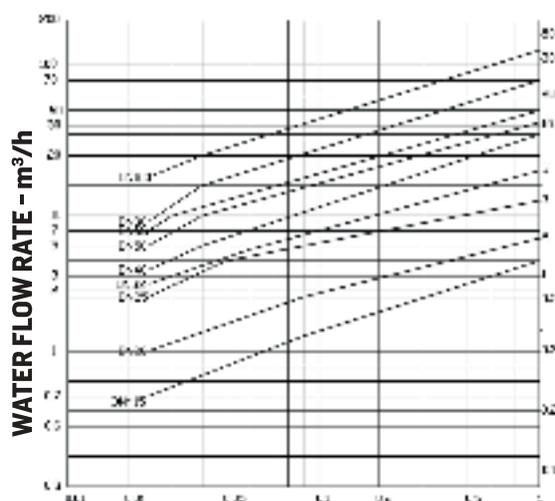

DN15-DN100 PRESSURE LOSS - bar

CV / KV PER VALVOLA DI RITEGNO CV / KV FOR NON-RETURN VALVE				DIREZIONE DI FLUSSO FLOW DIRECTION		
DE	DN DN inch	CV US gallon/min	KV m³/h	↑	↓	→
				Pressione di apertura Opening pressure (mbar)		
15	15 - 1/2"	4,1	3,5	25	21	23
18	15 - 1/2"	4,1	3,5	25	21	23
22	20 - 3/4"	5,1	4,4	25	21	23
28	25 - 1"	14	12	25	21	23
35	32 - 1 1/4"	23,3	20	27	21	24
42	40 - 1 1/2"	30,3	26	29	21	25
54	50 - 2"	37,3	32	29	21	25
76,1	65 - 2 1/2"	70	60	31	21	25
88,9	80 - 3"	81,7	70	32	21	26
108	100 - 4"	140	120	33	21	27

NOTE

Cv = flusso di acqua (a 60°F) in gpm (galloni al minuto) con una pressione differenziale (caduta di pressione) di 1 psi.

Kv = flusso di acqua (tra 5° e 40°) m³/h, con una pressione differenziale (caduta di pressione) di 1 bar.

(1 Kv = 0,86 Cv)

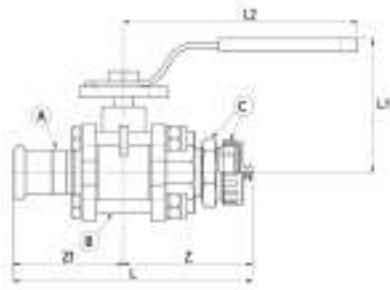

695/008 CN

VALVOLA A SFERA CON PRESA MANICHETTA

- BALL VALVE WITH HOSE CONNECTION
- KUGELHAHN MIT SCHLAUCHANSCHLUSS
- BOISSEAU SPHERIQUE AVEC RACCORD DETUYAU
- VÁLVULA DE BOLA CON CONEXIÓN DELA MANGUERA

MATERIAL: A: CuNi10Fe1.6Mn
 B: AISI 316L - 1.4404
 C: ottone - brass - Messing - laiton - latón

O-RING: FKM verde - green - Grün
 vert - verde

CODE	De mm	L mm	L1 mm	L2 mm	Z mm	Z1 mm	g			€
695022008CN	22 x 1"	136,5	80	151	73	63,5	1332	1	10	-



Klauke MAP219 BT MINI (∅ 12÷35 mm)

B 50 51

PRESSATRICE CON BATTERIA, CARICA BATTERIA E VALIGIA

- PRESSING MACHINE WITH BATTERY, CHARGER AND CASE
- AKKU- PRESSGERÄT MIT SCHNELLLADEGERAT UND KOFFER
- SERTISSEUSE A BATTERIE AVEC CHARGEUR ET COFFRET
- AKKU-MÁQUINA CON CARGADOR RÁPIDO Y CAJA

NOTE: New model (Bluetooth technology)

CODE	Voltage	Plug			€
196001018	(*) 220-240 V 50-60 Hz	(*) Europe (CEE 7/16 charge battery)	3,8	1	-



Klauke UNP2 (∅ 12÷54 mm)

B 50 51

PRESSATRICE ELETTROIDRAULICA CON VALIGIA

- ELECTROHYDRAULIC PRESSING MACHINE WITH CASE
- ELEKTROHYDRAULISCHES PRESSGERÄT MIT KOFFER
- SERTISSEUSE ELECTROHYDRAULIQUE AVEC COFFRET
- MÁQUINA ELECTROHIDRÁULICA CON CAJA

CODE	Voltage	Plug			€
196000000	220-240 V / 50-60 Hz	Europe (CEE 7/17)	11,8	1	-



Klauke UAP332 BT (∅ 12÷54 mm) i-press

B 50 51

PRESSATRICE CON BATTERIA, CARICA BATTERIA E VALIGIA

- PRESSING MACHINE WITH BATTERY, CHARGER AND CASE
- AKKU- PRESSGERÄT MIT SCHNELLLADEGERAT UND KOFFER
- SERTISSEUSE A BATTERIE AVEC CHARGEUR ET COFFRET
- AKKU-MÁQUINA CON CARGADOR RÁPIDO Y CAJA

NOTE: New model (Bluetooth technology)

CODE	Voltage	Plug			€
196001019	(*) 220-240 V 50-60 Hz	(*) Europe (CEE 7/16 charge battery)	8,1	1	-

B 50 51

Klauke UAP432 BT (\varnothing 12÷54 mm PN16 \varnothing 76÷108 mm PN10) i-press

PRESSATRICE CON BATTERIA, CARICA BATTERIA E VALIGIA

- PRESSING MACHINE WITH BATTERY, CHARGER AND CASE
- AKKU- PRESSGERÄT MIT SCHNELLLADEGERAT UND KOFFER
- SERTISSEUSE A BATTERIE AVEC CHARGEUR ET COFFRET
- AKKU-MÁQUINA CON CARGADOR RÁPIDO Y CAJA

NOTE: New model (Bluetooth technology)

CODE	Voltage	Plug	kg		€
196001020	[*] 220-240 V 50-60 Hz	[*] Europe (CEE 7/16 charge battery) (CEE 7/17 main adapter)	15	1	-

B 50 51

Klauke UAP100120 BT (\varnothing 76÷108 mm King size) i-press

PRESSATRICE CON BATTERIA, CARICA BATTERIA E VALIGIA

- PRESSING MACHINE WITH BATTERY, CHARGER AND CASE
- AKKU- PRESSGERÄT MIT SCHNELLLADEGERAT UND KOFFER
- SERTISSEUSE A BATTERIE AVEC CHARGEUR ET COFFRET
- AKKU-MÁQUINA CON CARGADOR RÁPIDO Y CAJA

NOTE: New model (Bluetooth technology)

CODE	Voltage	Plug	kg		€
196001021	[*] 220-240 V 50-60 Hz	[*] Europe (CEE 7/16 charge battery) (CEE 7/17 main adapter)	23,6	1	11196,42
196001009V*	-	-	10	1	-

[*] Valigia vuota - Empty case - Leer Koffer - Coffret vide - Caja vacía

B 50 51

Klauke EHP2/SANB (\varnothing 76÷108 mm King size)

GRUPPO POMPA IDRAULICA ELETTRICO

- ELECTRIC HYDRAULIC PUMP
- ELEKTRISCHEBETRIEBENES ANTRIEBSAGGREGAT
- GROUPE HYDRAULIQUE MOBILE POUR SERTIR
- UNIDAD DE ACCIONAMIENTO ELÉCTRICO

NOTE: Tensione/voltage 220-240 V / 50-60 Hz

CODE	Voltage	Plug	kg		€
196000000I	220-240 V / 50-60 Hz	CEE industrial 2P+G	69	1	-

**Klauke AHP700LS****B 50 51****GRUPPO POMPA IDRAULICA A BATTERIA**

- BATTERY HYDRAULIC PUMP
- AKKUBETRIEBENES ANTRIEBSAGGREGAT
- GROUPE HYDRAULIQUE MOBILE POUR SERTIR
- UNIDAD DE ACCIONAMIENTO A PILAS

CODE	Voltage	Plug			€
196001012	220-240 V 50-60 Hz	Europe (CEE 7/16 charge battery)	9,8	1	-

**Klauke PKUAP3 (∅ 12÷54 mm)
per/for AHP700LS****B 50 51****TESTA DI PRESSATRICE**

- PRESSING HEAD
- PRESSKÖPFE
- TÊTE DE SERTISSEUSE
- CABEZA DE AKKU-MÁQUINA

CODE			€
196001013	2,5	1	-

**Klauke PKUAP4 (∅ 12÷54 mm PN16)
(∅ 76,1÷108 mm PN10) per/for AHP700LS****B 50 51****TESTA DI PRESSATRICE**

- PRESSING HEAD
- PRESSKÖPFE
- TÊTE DE SERTISSEUSE
- CABEZA DE AKKU-MÁQUINA

CODE			€
196001017	2,6	1	-

**Klauke PK100AHP (∅ 76÷108 mm King size)
per/for AHP700LS****B 50 51****TESTA DI PRESSATRICE**

- PRESSING HEAD
- PRESSKÖPFE
- TÊTE DE SERTISSEUSE
- CABEZA DE AKKU-MÁQUINA

CODE			€
196001014	10,4	1	-



Klauke AHP700LS

B 50 51

TUBO FLESSIBILE ALTA PRESSIONE L=4 M

- HIGH PRESSURE HOSE L=4 M
- HOCHDRUCKSCHLAUCH L=4 M
- TUYAU À HAUTE PRESSION L=4 M
- MANGUERA DE ALTA PRESIÓN L=4 M

CODE			€
196001015	2,3	1	-



Klauke HPU2EX (ϕ 12÷54 mm)

B 50 51

PRESSATRICE MANUALE

- MANUAL HYDRAULIC PRESSING
- MANUELLES HYDRAULISCHES PRESSWERKZEUG
- SERTISSEUSE MANUELLE
- MÁQUINA MANUAL

CODE			€
196001016	3,1	1	-



Klauke MAP1 - MAP2L MINI

B 50 51

GANASCIA PER PRESSATRICE

- JAW
- PRESSBACKE
- MACHOIRE
- MORDAZA PINZA

CODE	De mm			€
196012001	12	1,28	1	-
196015001	15	1,28	1	-
196018001	18	1,28	1	-
196022001	22	1,34	1	-



Klauke MAP219

B 50 51

GANASCIA PER PRESSATRICE

- JAW
- PRESSBACKE
- MACHOIRE
- MORDAZA PINZA

CODE	De mm			€
196012002	12	1,3	1	-
196015002	15	1,3	1	-
196018002	18	1,3	1	-
196022002	22	1,4	1	-
196028002	28	1,4	1	-
196035002	35	1,6	1	-



Klauke UNP2 - UAP2 - UAP3L/432 UAP4L/432 - PKUAP3L

B 50 51

GANASCIA PER PRESSATRICE

- JAW
- PRESSBACKE
- MACHOIRE
- MORDAZA PINZA

CODE	De mm			€
196012000	12	1,9	1	-
196015000	15	1,9	1	-
196018000	18	1,9	1	-
196022000	22	2	1	-
196028000	28	2,1	1	-
196035000	35	2,1	1	-



Klauke UNP2 - UAP2 UAP3L/332 - UAP4L/432

B 50 51

VALIGIA PER GANASCE Ø 15÷35

- CASE FOR JAWS Ø 15÷35
- LEER KOFFER FÜR PRESSBACKEN Ø 15÷35
- COFFRET POUR MACHOIRES Ø 15÷35
- CAJA PARA MORZADAS Ø 15÷35

CODE	De mm			€
196015035K	15 - 35	13,2	1	-
196015035KV*	15 - 35	6,29	1	-

(*) Valigia vuota - Empty case - Leer Koffer - Coffret vide - Caja vacía



Klauke UNP2 - UAP2 - UAP3L/332 UAP4L/432 - PKUAP3

B 50 51

CATENA PER PRESSATRICE

- PRESSING COLLAR
- PRESSCHLINGE
- CHAÎNE
- MORDAZA CADENA

CODE	De mm			€
196042004	42	1,9	1	-
196054004	54	1,75	1	-



Klauke Ø 42÷54 mm

B 50 51

ADATTATORE PER CATENE

- ADAPTER FOR COLLARS
- ZWISCHENBACKE FÜR PRESSCHLINGEN
- ADAPTEUR POUR MACHOIRES
- ADAPTADOR PARA MORZAZAS

CODE	De mm			€
196042054	42 - 54	1,7	1	-



Klauke UAP4L/432 (PN10)

B 50 51

CATENA PER PRESSATRICE

- PRESSING COLLAR
- PRESSSCHLINGE
- CHAÎNE
- MORDAZA CADENA

CODE	De mm	kg		€
196076001	76,1	9,9	1	-
196088001	88,9	9,7	1	-
196108001	108	10,4	1	-



Klauke UAP4L/432 \varnothing 76÷108 mm (PN10)

B 50 51

ADATTATORE PER CATENE

- ADAPTER FOR COLLARS
- ZWISCHENBACKE FÜR PRESSSCHLINGEN
- ADAPTEUR POUR MACHOIRES
- ADAPTADOR PARA MORDAZAS

CODE	De mm	kg		€
196076108	76,1 - 108	4,4	1	-



Klauke UAP100 - UAP100L/100120 PK100AHP (\varnothing 76÷108 King size)

B 50 51

CATENA PER PRESSATRICE

- PRESSING COLLAR
- PRESSSCHLINGE
- CHAÎNE
- MORDAZA CADENA

CODE	De mm	kg		€
196076000	76,1	13	1	-
196088000	88,9	13	1	-
196108000	108	15	1	-



Klauke UNP2 - UAP3L/332 UAP4L/432 (\varnothing 42÷54 mm)

B 50 51

VALIGIA PER CATENE \varnothing 42÷54 + ADATTATORE

- CASE FOR PRESSING COLLARS \varnothing 42÷54 + ADAPTER
- LEER KOFFER FÜR PRESS SCHLINGEN \varnothing 42÷54 + ZWISCHENBACKE
- COFFRET POUR CHAÎNES \varnothing 42÷54 + ADAPTEUR
- CAJA PARA CADENA \varnothing 42÷54 + ADAPTADOR

CODE	De mm	kg		€
196042054KF	42 - 54	10,9	1	-
196042054K*	42 - 54	3,9	1	-

[*] Valigia vuota - Empty case - Leer Koffer - Coffret vide - Caja vacía



RA5 (12 V / 3,0 Ah) Klauke UAP2 - UAP100

B 50 51

BATTERIA

- BATTERY
- AKKU
- BATTERIE
- ACCUMULADOR

CODE	 kg		€
196002000	0,7	1	-



RAM3 (9,6 V / 3,0 Ah) Klauke MAP1 MINI

B 50 51

BATTERIA

- BATTERY
- AKKU
- BATTERIE
- ACCUMULADOR

CODE	 kg		€
196005000	0,6	1	-

B 50 51

NG2 (18 V)

Klauke UAP3L/332 - UAP4L/432 - UAP100L/100120

CAVO ELETTRICO CON ADATTATORE UNIVERSALE

- MAIN SUPPLY CIRCUIT
- SCHALTNETZTEIL
- BLOC D'ALIMENTATION
- ALIMENTADOR A LA RED

CODE	Voltage	Plug			€
196004001	220-240 V / 50-60 Hz	Europe (CEE 7/17)	0,9	1	-

B 50 51

RAL2 (18 V / 3,0 Ah)

Klauke MAP2L/219 - UAP3L/332 UAP4L/432 - UAP100L/100120

BATTERIA

- BATTERY
- AKKU
- BATTERIE
- ACCUMULADOR

CODE			€
196002001	0,7	1	-

B 50 51

LGL1

Klauke UAP3L/332 - UAP4L/432 - UAP100L/100120

CARICABATTERIA

- FAST CHARGER
- SCHNELLLADEGERÄT
- CHARGEUR
- CARGADOR RÁPIDO

CODE	Voltage	Plug			€
196003001	220-240 V / 50-60 Hz	Europe (CEE 7/16)	1,3	1	-

B 50 51



Novopress ECO 203 (Ø 12÷54 mm)

PRESSATRICE ELETTROIDRAULICA CON VALIGIA

- ELECTROHYDRAULIC PRESSING MACHINE WITH CASE
- ELEKTROHYDRAULISCHES PRESSGERÄT MIT KOFFER
- SERTISSEUSE ELECTROHYDRAULIQUE AVEC COFFRET
- MÁQUINA ELECTROHIDRÁULICA CON CAJA

CODE	Voltage	Plug	kg	Box	€
196000013	220-240 V / 50-60 Hz	Europe (CEE 7/17)	7,9	1	-
196000015	110-120 V / 50-60 Hz	Great Britain (BS 1363)	7,9	1	-



Novopress ACO 203 BT (Ø 12÷54 mm)

PRESSATRICE CON BATTERIA, CARICA BATTERIA E VALIGIA

- PRESSING MACHINE WITH BATTERY, CHARGER AND CASE
- AKKU- PRESSGERÄT MIT SCHNELLLADEGERÄT UND KOFFER
- SERTISSEUSE A BATTERIE AVEC CHARGEUR ET COFFRET
- AKKU-MÁQUINA CON CARGADOR RÁPIDO Y CAJA

NOTE: New model (Bluetooth technology)

CODE	Voltage	Plug	kg	Box	€
196000021	(*) 220-240 V / 50-60 Hz	(*) Europe (CEE 7/16)	8,0	1	-
196000025	(*) 110-120 V / 50-60 Hz	(*) USA / Canada (NEMA 1-15)	8,1	1	-



Novopress ACO 203 XL BT (Ø 12÷54 mm PN16 / Ø 76÷108 mm PN10)

PRESSATRICE CON 2 BATTERIE, CARICA BATTERIA E VALIGIA

- PRESSING MACHINE WITH 2 BATTERIES, CHARGER AND CASE
- AKKU- PRESSGERÄT MIT SCHNELLLADEGERÄT UND KOFFER
- SERTISSEUSE A BATTERIE (2) AVEC CHARGEUR ET COFFRET
- AKKU-MÁQUINA CON CARGADOR RÁPIDO Y CAJA

NOTE: New model (Bluetooth technology)

CODE	Voltage	Plug	kg	Box	€
196000024	(*) 220-240 V / 50-60 Hz	(*) Europe (CEE 7/16)	10	1	-



Novopress ACO 403 BT (Ø 76÷168 mm)

PRESSATRICE CON 2 BATTERIE, CARICA BATTERIA E VALIGIA

- PRESSING MACHINE WITH 2 BATTERIES, CHARGER AND CASE
- AKKU- PRESSGERÄT MIT SCHNELLLADEGERÄT UND KOFFER
- SERTISSEUSE A BATTERIE (2) AVEC CHARGEUR ET COFFRET
- AKKU-MÁQUINA CON CARGADOR RÁPIDO Y CAJA

NOTE: New model (Bluetooth technology)

CODE	Voltage	Plug	kg	Box	€
196000023	(*) 220-240 V / 50-60 Hz	(*) Europe (CEE 7/16)	20,4	1	-

**Novopress EFP 2 - EFP/AFP 201 - EFP/AFP 202
ECO/ACO 202 - ECO/ACO 203 - ACO 203XL**
B 50 51
GANASCIA PER PRESSATRICE

- JAW
- PRESSBACKE
- MACHOIRE
- MORDAZA PINZA

CODE	De mm	kg	Box	€
19601200N	12	1,9	1	-
19601500N	15	1,9	1	-
19601800N	18	1,9	1	-
19602200N	22	2	1	-
19602800N	28	2	1	-
19603500N	35	2	1	-

**Novopress EFP 2 - EFP/AFP 201 - EFP/AFP 202
ECO/ACO 202 - ECO/ACO 203 - ACO 203XL**
B 50 51
VALIGIA PER GANASCE Ø 15÷35

- CASE FOR JAWS Ø 15÷35
- LEER KOFFER FÜR PRESSBACKEN Ø 15÷35
- COFFRET POUR MACHOIRES Ø 15÷35
- CAJA PARA MORZADAS Ø 15÷35

CODE	De mm	kg	Box	€
196015035N	15 - 35	12,6	1	-
196015035NV*	15 - 35	2,8	1	-

(*) Valigia vuota - Empty case - Leer Koffer - Coffret vide - Caja vacía

**Novopress EFP 2 - EFP/AFP 201-202
ECO/ACO 202-203 - ACO 203XL - ECO301**
B 50 51
CATENA PER PRESSATRICE

- PRESSING COLLAR
- PRESSCHLINGE
- CHAÎNE
- MORDAZA CADENA

CODE	De mm	kg	Box	€
19604200N	42	1,6	1	-
19605400N	54	2,6	1	-

**Novopress EFP 2 - EFP/AFP 201 - EFP/AFP 202
ECO/ACO 202 - ECO/ACO 203 - ACO 203XL**
B 50 51
ADATTATORE PER CATENE ZB203

- ADAPTER FOR COLLARS ZB203
- ZWISCHENBACKE FÜR PRESSCHLINGEN ZB203
- ADAPTEUR POUR MACHOIRES ZB203
- ADAPTADOR PARA MORDAZAS ZB203

CODE	De mm	kg	Box	€
196042054N	42 - 54	2,3	1	-



Novopress EFP 2 - EFP/AFP 201 - EFP/AFP 202 ECO/ACO 202 - ECO/ACO 203 - ACO 203XL

B 50 51

VALIGIA PER CATENE Ø 42÷54 + ADATTATORE ZB203

- CASE FOR PRESSING COLLARS Ø 42÷54 + ADAPTER ZB203
- LEER KOFFER FÜR PRESS SCHLINGEN Ø 42÷54 + ZWISCHENBACKE ZB203
- COFFRET POUR CHAÎNES Ø 42÷54 + ADAPTEUR ZB203
- CAJA PARA CADENA Ø 42÷54 + ADAPTADOR ZB203

CODE	De mm	kg		€
196042054VN	42 - 54	8	1	-
196042054V*	42 - 54	2,8	1	-

(*) Valigia vuota - Empty case - Leer Koffer - Coffret vide - Caja vacía



Novopress ACO 203 XL - ECO 301 (Ø 76÷108 mm PN10)

B 50 51

CATENA PER PRESSATRICE

- PRESSING COLLAR
- PRESSSCHLINGE
- CHAÎNE
- MORDAZA CADENA

CODE	De mm	kg		€
196076003	76,1	4,4	1	-
196088003	88,9	4,8	1	-
196108003	108	6	1	-



Adattatore ZB 221 per catene Ø 76,1-88,9-108/1 ACO 203 XL (PN10)

B 50 51

ADATTATORE PER CATENE

- ADAPTER FOR COLLARS
- ZWISCHENBACKE FÜR PRESSSCHLINGEN
- ADAPTEUR POUR MACHOIRES
- ADAPTADOR PARA MORDAZAS

CODE	De mm	kg		€
196076108N*	76,1 - 88,9 - 108 (1°)	4,7	1	-

(*) Per pressatura preliminare diametro 108 mm; il giunto DN 108 mm deve essere pressato una seconda volta con adattatore codice 196000108N. Preliminary pressing for diameter 108 mm; DN 108 mm joint must be pressed a second time with adapter item 196000108N.



Adattatore ZB 222 per catena Ø 108/2 ACO 203 XL (PN10)

B 50 51

ADATTATORE PER CATENE

- ADAPTER FOR COLLARS
- ZWISCHENBACKE FÜR PRESSSCHLINGEN
- ADAPTEUR POUR MACHOIRES
- ADAPTADOR PARA MORDAZAS

CODE	De mm	kg		€
196000108N	108 (2°)	5,2	1	-



Novopress ACO 203 XL (PN10) Novopress ZB 221 / ZB 222 per catene \varnothing 76-108

B 50 51

SET ADATTATORI ZB221/ZB222

- ADAPTERS SET ZB221/ZB222
- ADAPTER SET ZB221/ZB222
- SET DES ADAPTATEURS ZB221/ZB222
- SET DE ADAPTADORES ZB221/ZB222

CODE			€
196000019	13	1	-
196000000VN*	3,1	1	-

[*] Valigia vuota - Empty case - Leer Koffer - Coffret vide - Caja vacía



Novopress ACO 401/403 (\varnothing 76÷108 King size)

B 50 51

CATENA PER PRESSATRICE

- PRESSING COLLAR
- PRESSSCHLINGE
- CHAÎNE
- MORDAZA CADENA

CODE	De mm			€
196076002	76,1	6	1	-
196088002	88,9	8	1	-
196108002	108	9	1	-



Novopress ACO 401/403 (\varnothing 139÷168 Over size)

B 50 51

CATENA PER PRESSATRICE

- PRESSING COLLAR
- PRESSSCHLINGE
- CHAÎNE
- MORDAZA CADENA

CODE	De mm			€
196139002	139,7	14,4	1	-
196168002	168,3	19,7	1	-



Novopress ACO 202/203 - ACO 401

B 50 51

CARICABATTERIA

- FAST CHARGER
- SCHNELLLADEGERÄT
- CHARGEUR
- CARGADOR RÁPIDO

CODE	Voltage	Plug			€
19600300N	220-240 V / 50-60 Hz	Europe (CEE 7/16)	0,97	1	-



Novopress - Akku

B 50 51

BATTERIA

- BATTERY
- AKKU
- BATTERIE
- ACCUMULADOR

CODE	Version			€
19600204N	18 V / 2,0 Ah Li • ACO 202/203/401/403	0,5	1	-
19600205N	18 V / 5,0 Ah Li • ACO 202/203/401/403	0,9	1	-
19600200N	14,4 V / 2,4 Ah Ni-Cd • AFP 201	0,9	1	-
19600201N	14,4 V / 2,0 Ah Ni-Cd • AFP 202	0,9	1	-
19600202N	18 V / 3,0 Ah Li • AFP 202	0,8	1	-

B 50 51

116/1

TAGLIATUBI MANUALE

- PIPE CUTTER
- ROHRSCHEIDER
- COUPE-TUBES
- CORTATUBO

CODE	De mm	kg	Box	€
116000011	6 ÷ 60	0,350	1	-

B 50 51

116/2

ROTELLA TAGLIATUBI

- CUTTING WHEEL
- SCHNEIDRAD FÜR ROHRSCHEIDER
- MOLETTE POUR COUPE-TUBES
- CUCHILLA

CODE	Version	De mm	g	Box	€
116000012	For pipe cutter code / Per tagliatubi codice 116000011	6 ÷ 60	38	1	-

B 50 51

116/0 (ø 12÷54 mm)

SBAVATORE UNIVERSALE TUBI

- PIPE DEBURRER
- ENTGRATER
- EBAVUREUR DE TUBE
- DESBARBADOR

CODE	De mm	g	Box	€
116000000	10 ÷ 54	612	1	-

B 50 51

116/3 (ø 76÷108 mm)

SBAVATORE UNIVERSALE TUBI

- PIPE DEBURRER
- ENTGRATER
- EBAVUREUR DE TUBE
- DESBARBADOR

CODE	De mm	g	Box	€
116000003	63 ÷ 110	1942	1	-

**116/18****B 50 51****TAGLIATUBI ELETTRICO - CENTO**

- ELECTRIC PIPE CUTTER - CENTO
- ELEKTRISCH ROHRSCHEIDER - CENTO
- ÉLECTRIQUE COUPE-TUBES - CENTO
- CORTATUBO ELÉCTRICO - CENTO

NOTE: Esclusa rotella - wheel excluded - Schneidrad separat
molette exclue - cuchilla excluida

CODE	De mm			€
116000018	12 ÷ 108	19,070	1	-

**116/28****B 50 51****TAGLIATUBI ELETTRICO - DUECENTO**

- ELECTRIC PIPE CUTTER - DUECENTO
- ELEKTRISCH ROHRSCHEIDER - DUECENTO
- ÉLECTRIQUE COUPE-TUBES - DUECENTO
- CORTATUBO ELÉCTRICO - DUECENTO

NOTE: Esclusa rotella - wheel excluded - Schneidrad separat
molette exclue - cuchilla excluida

CODE	De mm			€
116000028	54 ÷ 225	43,800	1	-

**116/38****B 50 51****ROTELLA PER TAGLIATUBO CENTO-DUECENTO**

- CUTTING WHEEL PIPE CUTTER CENTO-DUECENTO
- SCHNEIDRAD ROHRSCHEIDER CENTO-DUECENTO
- MOLETTE POUR COUPE-TUBES CENTO-DUECENTO
- CUCHILLA PARA CORTATUBO CENTO-DUECENTO

CODE			€
116000038	300	1	-

**116/48****B 50 51****PIEDISTALLO TAGLIATUBI CENTO**

- PEDESTAL FOR CENTO PIPE CUTTER
- SOCKEL FÜR CENTO ROHRSCHEIDER
- PIÉDESTAL POUR COUPE-TUBES CENTO
- PEDESTAL PARA CORTATUBO CENTO

CODE			€
116000048	9,550	1	-

**116/58****B 50 51****CAVALLETTO PER TUBI Ø 8÷108 MM**

- EASEL FOR PIPES Ø 8÷108 MM
- GESTELL FÜR ROHR Ø 8÷108 MM
- CHEVALET POUR PIPE Ø 8÷108 MM
- CABALLETE DE TUBO Ø 8÷108 MM

CODE			€
116000058	7,000	1	-

116/6 (ø 15÷54 mm)
B 50 51
SPELATUBI

- DISMANTLING TOOL
- ABMANTELGERÄT
- DÉNUDEUR
- PELADOR

CODE	De mm	 g		€
11600006	15 - 22	236	1	-
11600016	18 - 28	320	1	-
11600026	35 - 42	703	1	-
11600036	54	477	1	-

116/7 (ø 76÷108 mm)
B 50 51
SPELATUBI

- DISMANTLING TOOL
- ABMANTELGERÄT
- DÉNUDEUR
- PELADOR

CODE	De mm	 kg		€
116076007	76,1	1,040	1	-
116088007	88,9	1,218	1	-
116108007	108	1,668	1	-

274/0 (ø 15÷54 mm)
B 50 51
MARCATORE

- MARKER
- MARKIERLEHRE
- MARQUEUR
- MARCATUBO

CODE	De mm	 g			€
274000000	15 ÷ 54	26	1	50	-

**274/1 (ø 76÷108 mm)****B 50 51****MARCATORE**

- MARKER
- MARKIERLEHRE
- MARQUEUR
- MARCATUBO

CODE	De mm			€
274000001	76,1 ÷ 108	190	1	-

**274/CAP****B 50 51****TAPPO DI PROTEZIONE TUBO**

- PIPE PROTECTION CAP
- ROHRSCHUTZKAPPE
- BOUCHON DE PROTECTION TUYAU
- TAPA DE PROTECCIÓN TUBERÍA

CODE	De mm				€
274015001	15	1	10	150	-
274018001	18	2	10	150	-
274022001	22	2	10	100	-
274028001	28	3	10	200	-
274035001	35	3	10	150	-
274042001	42	6	5	50	-
274054001	54	13	5	50	-
274076001	76,1	16	5	50	-
274088001	88,9	20	5	40	-
274108001	108	27	5	20	-

B 50 52

O-Ring EPDM

NERO

- BLACK
- SCHWARZ
- NOIR
- NEGRO

NOTE: Impieghi / Application field / Einsatzgebiete / Champs d'application /
 Aplicaciones:
 Idrosanitaria / riscaldamento / raffrescamento
 Sanitary / Heating / Cooling
 Sanitär / Heizung / Kühlung
 Sanitaire / Chauffage /Circuits réfrigérants
 Agua sanitaria / Calefacción / Circuito de refrigeración

Material: EPDM

Profilo M - M profile - M Kontur - profil M - perfil M

CODE	De mm	 g		€
11501525N	15	1	20	-
11501825N	18	1	20	-
11502230N	22	1	20	-
11502830N	28	2	20	-
11503530N	35	2	20	-
11504240N	42	5	20	-
11505440N	54	6	20	-
11507770NM	76,1	14	10	-
11509070NM	88,9	17	10	-
11510909NM	108	33	10	-
115139100N	139,7	43	1	-
115168100N	168,3	95	1	-

B 50 52

O-Ring NBR-HNBR

GIALLO

- YELLOW
- GELB
- JAUNE
- AMARILLO

NOTE: Impieghi / Application field / Einsatzgebiete / Champs d'application /
 Aplicaciones:
 Gas / Gas / Gas / Gaz / Gas

Material: NBR / HNBR

Profilo M - M profile - M Kontur - profil M - perfil M

CODE	De mm	 g		€
11501526G	15	1	20	-
11501826G	18	1	20	-
11502231G	22	1	20	-
11502831G	28	2	20	-
11503532G	35	2	20	-
11504241G	42	5	20	-
11505441G	54	6	20	-
11507670GM*	76,1	14	10	-
11508870GM*	88,9	17	10	-
11510809GM*	108	33	10	-

(*) HNBR

B 50 52



O-Ring FKM

VERDE

- GREEN
- GRÜN
- VERT
- VERDE

NOTE: Impieghi / Application field / Einsatzgebiete / Champs d'application /
Aplicaciones:
Solare / Solar / Solar / Solaire / Solares
Olio / Pil / Öl / Huile / Aceite

Material: FKM

Profilo M - M profile - M Kontur - profil M - perfil M

CODE	De mm			€
11501525V	15	1	20	-
11501825V	18	1	20	-
11502230V	22	1	20	-
11502830V	28	2	20	-
11503530V	35	2	20	-
11504240V	42	5	20	-
11505440V	54	6	20	-
11507770VM	76,1	14	10	-
11509070VM	88,9	17	10	-
11510909VM	108	33	10	-
115139100V	139,7	43	1	-
115168100V	168,3	95	1	-

B 50 52



O-Ring MVQ

ROSSO

- RED
- ROT
- ROUGE
- ROJO

NOTE: Impieghi / Application field / Einsatzgebiete / Champs d'application /
Aplicaciones:
Applicazioni industriali - chiedere ad RM
Industrial applications - ask RM
Industrieanwendungen - fragen RM
Applications industrielles - demander RM
Aplicaciones industriales - preguntar RM

Material: MVQ

Profilo M - M profile - M Kontur - profil M - perfil M

CODE	De mm			€
11501525R	15	1	20	-
11501825R	18	1	20	-
11502230R	22	1	20	-
11502830R	28	2	20	-
11503530R	35	2	20	-
11504240R	42	5	20	-
11505440R	54	6	20	-
11507770R	76,1	14	10	-
11509070R	88,9	17	10	-
11510990R	108	33	10	-

B 50 52

115/EPDM

GUARNIZIONE EPDM

- EPDM GASKET
- DICTUNG AUS EPDM
- JOINT EPDM
- JUNTA EN EPDM

NOTE: Impieghi / Application field / Einsatzgebiete / Champs d'application /
 Aplicaciones:
 Idrosanitaria / riscaldamento / raffrescamento
 Sanitary / Heating / Cooling
 Sanitär / Heizung / Kühlung
 Sanitaire / Chauffage / Circuits réfrigérants
 Agua sanitaria / Calefacción / Circuito refrigeración

CODE	De mm	D1 mm	D2 mm	S mm			€
115683102E	15 - 18	18	10	2,5	1	20	-
115683304E	15 - 18 - 22	24	14	2,5	1	20	-
115683100E	18 - 22 - 28	30	20	2,5	1	20	-
115683114E	28 - 35	39	27	2,5	2	20	-
115683112E	35 - 42	44,5	34	2,5	3	20	-
115183134E	42	50,5	40	2,5	3	20	-
115683134E	42	50,5	38	2,5	4	20	-
115183200E	42	56	42	2,5	4	20	-
115183540E	54	65,5	53,5	3	4	20	-
115183154E	54	65,5	45	3	4	20	-
115183054E	54	71,5	53	3	5	20	-

B 50 52

115/HNBR

GUARNIZIONE HNBR

- HNBR GASKET
- DICTUNG AUS HNBR
- JOINT HNBR
- JUNTA EN HNBR

NOTE: Impieghi / Application field / Einsatzgebiete / Champs d'application /
 Aplicaciones:
 Gas / Gas / Gas / Gaz / Gas

CODE	De mm	D1 mm	D2 mm	S mm			€
115683102H	15 - 18	18	10	2,5	1	20	-
115683304H	15 - 18	24	14	2,5	1	20	-
115683100H	22 - 28	30	20	2,5	1	20	-
115683114H	28 - 35	39	27	2,5	2	20	-
115183112H	35 - 42	44,5	34	2,5	3	20	-
115183200H	42 - 54	56	42	2,5	4	20	-

B 50 52**115/FKM****GUARNIZIONE FKM**

- FKM GASKET
- DICTUNG AUS FKM
- JOINT FKM
- JUNTA EN FKM

NOTE: Impieghi / Application field / Einsatzgebiete / Champs d'application /
Aplicaciones:
Solare / Solar / Solar / Solaire / Solares.

CODE	De mm	D1 mm	D2 mm	S mm			€
115683102F	15 - 18	18	10	3	1	20	-
115683304F	15 - 18 - 22	24	14	3	1	20	-
115683100F	18 - 22 - 28	30	20	3	1	20	-
115683114F	28 - 35	39	27	3	2	20	-
115183112F	35 - 42	44,5	34	3	3	20	-
115183051F	28	47,5	37	3	3	20	-
115183134F	42	50,5	40	3	4	20	-
115183200F	42 - 54	56	42	3	4	20	-
115183540F	54	65,5	53,5	3	4	20	-
115183242F	42	66	56	3	4	20	-
115183054F	54	71,5	53	3	5	20	-
115183254F	54	79,5	69	3	5	20	-

**850NS****BENDA DI PROTEZIONE BUTILICA RACCORDI STEELPRES**

- BANDAGE PROTECTION FOR STEELPRES FITTINGS
- SCHUTZBAND FÜR STEELPRES FITTINGE
- BANDE DE PROTECTION POUR RACCORDS STEELPRES
- FUNDA DE PROTECCION PIEZAS STEELPRES

B 60 60

CODE	Lg x L cm x m			€
850NS000000	5 cm x 9,15 m	734	24	-

Raccomandato per impianti di raffrescamento
Recommended for cooling installation
Empfehl fuer Kuehlungsanlagen
Recommandé pour installations de refroidissement
Recomendado para instalaciones de refrigeracion

FOCUS ON

Umidità e condensa: quando si forma, perché?

La condensa è un fenomeno naturale che si manifesta quando l'aria carica di vapore acqueo entra in contatto con superfici fredde.

La differenza di temperatura tra aria calda e superficie fredda provoca la trasformazione del vapore in gocce d'acqua.

Effetto della condensa sui tubi in acciaio al carbonio zincati.

Negli impianti di raffrescamento realizzati con tubi zincati non adeguatamente protetti, l'eventuale formazione di condensa sulla superficie esterna del tubo in presenza di ossigeno, provoca la formazione di ossido di zinco. Una volta consumato tutto lo zinco superficiale, sulla sottostante superficie in acciaio al carbonio si innesca una corrosione generalizzata con formazione di ossido di ferro.

Come risolvere il problema?

Per preservare il tubo in acciaio al carbonio è necessario rivestire la sua superficie con un materiale protettivo che non si ossidi e che svolga azione di barriera fisica tra tubazione ed atmosfera.

Quale soluzione offre RM?

Per facilitare la fase di installazione e protezione delle tubazioni e dei raccordi Steelpres, mettiamo a disposizione tubo in acciaio al carbonio zincato rivestito con PP e bende butiliche da nastrire sopra i raccordi.

Protezione di tubi e raccordi dalla corrosione esterna.

Il nastro adesivo isobutilico presenta grande allungabilità in entrambi i sensi ed un forte potere adesivo ed auto amalgamante. Lo stesso non necessita di primer aggrappante, impermeabilizza perfettamente le superfici, isolando da agenti atmosferici e chimici blandi. La grande allungabilità conferisce ai nastri un'adattabilità pressochè universale su tutte le superfici, anche le più irregolari quali curve,



Tee, giunti a bicchiere etc. Per applicarlo è sufficiente che la superficie sia pulita e non umida. Il nastro va spellicolato esercitando la tensione necessaria a seconda delle situazioni. Esso si allunga infatti fino al 700% della sua lunghezza iniziale mentre lo spessore finale è in funzione della trazione esercitata. È consigliabile una sovrapposizione di almeno un 10% della larghezza del nastro.

La protezione attraverso il rivestimento con fasce e/o verniciatura, deve comunque avvenire sempre dopo la prova impianto.

RM's solution.

To ease the phases of installation and protection zinc-plated carbon steel pipe coated with PP and butyl tapes to be applied onto fittings.

Protection of pipelines and connections from external corrosion.

The butanol-adhesive tape has high tensile and high adhesive strength and is selffluxing. It requires no adherent primer, lets surfaces perfectly repel water and insulates against atmospheric influences and free chemicals.

The high tensibility provides the tapes with comprehensive applicability for all types of surfaces, even for irregular surfaces such as bends, T-piece, sleeves, etc.

For the application, it is sufficient that the surface is clean but not wet.

The tape must be under pressure and cleaned depending on the situation. It extends over 700% compared to its original length, while the width at the end depends on the extension.

It is recommended to overlap the tape with at least 10% of the tape width. A coating protection with the help of tapes and/or varnish must always occur after a trial run of the system.

Humidity and condensate: when and why it creates.

Condensate is a natural event appearing when the air rich in water vapour comes into contact with cold surfaces.

The difference in temperature between hot air and cold surfaces brings about the transformation of vapour in water drops.

Effects of condensate on zincplated carbon steel pipes.

In cooling systems obtained from not suitably protected zinc-plated pipes, possible condensate creation on pipes' outer surface in presence of oxygen causes the formation of zinc oxide. After superficial zinc consumption, on carbon steel surface under zinc coating a general corrosion starts with the formation of iron oxide.

How to solve the problem.

In order to protect carbon steel pipes, it is necessary to coat its surface by a protective material that does not oxidise and acts as physical barrier between pipe and atmosphere.



Sistemi di scarico

WASTE SYSTEMS

ABFLUSSSYSTEME

SYSTÈMES DE EVACUATION

SISTEMAS DE EVACUACIÓN

Raccorderie Metalliche **DRAIN**

RM DRAIN è un sistema di scarico composto da elementi tubiformi e raccordi in acciaio inossidabile AISI 316L (1.4404) a parete sottile, particolarmente adatto per convogliare, sia a gravità che sottovuoto, acque reflue frequentemente contaminate da sostanze organiche e chimiche corrosive. Il vasto assortimento dei componenti è disponibile in sette dimensioni, dal DN 40 al DN 150 (DN 200 in fase di realizzazione). Grazie alla loro elevata resistenza al fuoco (Certificati Classe A, non combustibili), consente di soddisfare molteplici installazioni, in particolare quelle in ambito navale (navi da crociera, navi militari, yacht, strutture offshore, ecc.).

RM DRAIN is a draining system consisting of tubes and joints in AISI 316L (1.4404) stainless steel, thin wall, suitable to convey, with gravity or under vacuum, waste waters which are frequently contaminated with organic or chemical corrosive substances. The wide range of products is available in seven sizes, DN 40 to DN 150 (DN 200 work in progress). As they are consistently fire resistant, (certified class A, not combustible), they allow to comply with many installation requirements as for marine installations (cruise ships, military ships, yacht, offshore structures, etc.).



Il montaggio del sistema RM DRAIN richiede semplici e rapide operazioni manuali che non obbligano l'utilizzo di particolari e spesso costose attrezzature.

The RM DRAIN assembling procedure asks for simple and rapid manual operations, with no specific or expensive tool.



1 Verificare pulizia componenti / Verify the components' cleaning



2 Inserire guarnizione nel bicchiere / Insert the gasket into socket



3 Verificare posizionamento guarnizione / Verify the correct gasket's position



4 Marcatura quota d'innesto / Marking the insertion's depth



5 Lubrificazione zona interna guarnizione / Internal gasket lubrication



6 Inserimento tubo nel raccordo / Inserting of the pipe into the fitting



7 Pulizia di eventuale grasso residuo / Cleaning of the grease residual



8 Controllo completo inserimento del tubo nel bicchiere // Check of complete pipe's insertion into the fitting

Certificazioni / Certifications

		PIPES AND FITTINGS FOR VACUUM AND GRAVITY DRAIN SYSTEM - RM DRAIN	LR2003327TA
		PIPE PENETRATION RM DRAIN M1-M2-M3-M4	MED 1650184
		RM DRAIN TUBAZIONI DI SCARICO A GRAVITÀ E VUOTO RM DRAINING SYSTEMS - GRAVITY AND VACUUM	MAC - 412019CS / 001 - 002
		PIPES AND FITTINGS FOR VACUUM AND GRAVITY DRAIN SYSTEM - RM DRAIN	TAP000017F
		DRAINING SYSTEM	POCC IT.AM05.H05079

FOCUS ON

DIMENSIONI DEL BICCHIERE / SOCKET SIZE

DN	D mm	S mm	D1 mm	D2 mm	D3 mm	P mm
DN 40	42	1	45	48	45	30
DN 50	53	1	56	60	56	38
DN 65	73	1,25	76	81	76	55
DN 80	88,9	1,25	92	99	92	60
DN 100	102	1,25	106	114	107	70
DN 125	133	1,5	138	147	140	75
DN 150	159	1,5	164	176	168	80

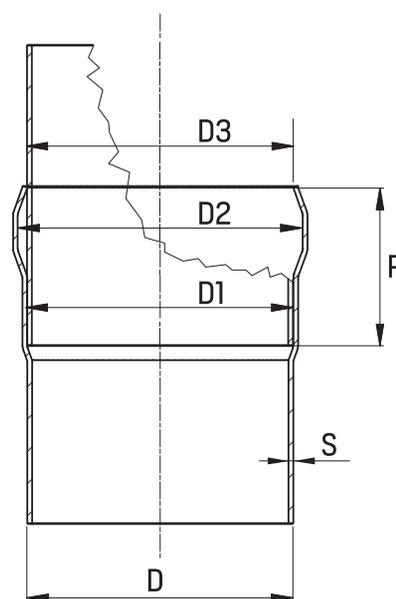

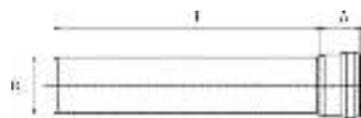

802

TUBO CON UN BICCHIERE

- PIPE WITH ONE SOCKET
- ROHR MIT EINER MUFFE
- TUYAU AVEC UNE EMBOITURE
- TUBO CON UN MANGUITO

MATERIAL: AISI 316L - 1.4404
GASKET: EPDM cod. 826/GV (Ø 40 ÷ 65)
 EPDM cod. 826/G (Ø 80 ÷ 150)
NORM: EN 1124-3

CODE	DN	D1 mm	L mm	A mm	kg		€
802040025	40	42	250	30	0,295	1	-
802040050		42	500	30	0,550	1	-
802040075		42	750	30	0,810	1	-
802040100		42	1000	30	1,065	1	-
802040150		42	1500	30	1,580	1	-
802040200		42	2000	30	2,100	1	-
802040250		42	2500	30	2,610	1	-
802040300		42	3000	30	3,120	1	-
802050025	50	53	250	38	0,385	1	-
802050050		53	500	38	0,710	1	-
802050075		53	750	38	1,040	1	-
802050100		53	1000	38	1,365	1	-
802050150		53	1500	38	2,020	1	-
802050200		53	2000	38	2,670	1	-
802050250		53	2500	38	3,320	1	-
802050300		53	3000	38	3,970	1	-
802060025	65	73	250	55	0,710	1	-
802060050		73	500	55	1,270	1	-
802060075		73	750	55	1,850	1	-
802060100		73	1000	55	2,400	1	-
802060150		73	1500	55	3,550	1	-
802060200		73	2000	55	4,650	1	-
802060250		73	2500	55	5,800	1	-
802060300		73	3000	55	6,900	1	-
802080025	80	88,9	250	60	0,875	1	-
802080050		88,9	500	60	1,600	1	-
802080075		88,9	750	60	2,250	1	-
802080100		88,9	1000	60	2,950	1	-
802080150		88,9	1500	60	4,320	1	-
802080200		88,9	2000	60	5,700	1	-
802080250		88,9	2500	60	7,700	1	-
802080300		88,9	3000	60	8,450	1	-
802100025	100	102	250	70	1,050	1	-
802100050		102	500	70	1,850	1	-
802100075		102	750	70	2,620	1	-
802100100		102	1000	70	3,400	1	-
802100150		102	1500	70	4,980	1	-
802100200		102	2000	70	6,550	1	-
802100250		102	2500	70	8,130	1	-
802100300		102	3000	70	9,700	1	-
802125025	125	133	250	75	1,650	1	-
802125050		133	500	75	2,885	1	-

B 100 101**802****TUBO CON UN BICCHIERE**

- PIPE WITH ONE SOCKET
- ROHR MIT EINER MUFFE
- TUYAU AVEC UNE EMBOITURE
- TUBO CON UN MANGUITO

MATERIAL: AISI 316L – 1.4404**GASKET:** EPDM cod. 826/GV (Ø 40 ÷ 65)

EPDM cod. 826/G (Ø 80 ÷ 150)

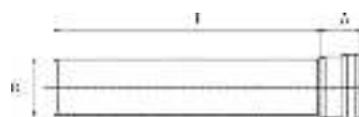
NORM: EN 1124-3

CODE	DN	D1 mm	L mm	A mm			€
802125075	125	133	750	75	4,125	1	-
802125100		133	1000	75	5,360	1	-
802125150		133	1500	75	7,830	1	-
802125200		133	2000	75	10,300	1	-
802125250		133	2500	75	12,775	1	-
802125300		133	3000	75	15,250	1	-
802150025	150	159	250	80	2,000	1	-
802150050		159	500	80	3,500	1	-
802150075		159	750	80	5,000	1	-
802150100		159	1000	80	6,450	1	-
802150150		159	1500	80	9,400	1	-
802150200		159	2000	80	12,400	1	-
802150250		159	2500	80	15,350	1	-
802150300		159	3000	80	18,300	1	-

B 100 101**803****TUBO CON DUE BICCHIERI**

- PIPE WITH TWO SOCKETS
- ROHR MIT ZWEI MUFFEN
- TUYAU AVEC DEUX EMBOITURES
- TUBO CON DOS MANGUITOS

MATERIAL: AISI 316L – 1.4404**GASKET:** EPDM cod. 826/GV (Ø 40 ÷ 65)

EPDM cod. 826/G (Ø 80 ÷ 150)

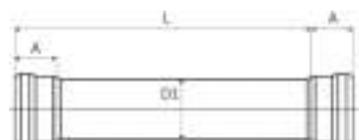
NORM: EN 1124-3

CODE	DN	D1 mm	L mm	A mm			€	
8030400250	40	42	250	30	0,330	1	-	
8030400500		42	500	30	0,580	1	-	
8030400750		42	750	30	0,860	1	-	
8030401000		42	1000	30	1,100	1	-	
8030401500		42	1500	30	1,600	1	-	
8030402000		42	2000	30	2,150	1	-	
8030402500		42	2500	30	2,650	1	-	
8030403000		42	3000	30	3,150	1	-	
8030500250		50	53	250	38	0,420	1	-
8030500500			53	500	38	0,755	1	-
8030500750	53		750	38	1,080	1	-	
8030501000	53		1000	38	1,400	1	-	
8030501500	53		1500	38	2,100	1	-	
8030502000	53		2000	38	2,700	1	-	
8030502500	53		2500	38	3,350	1	-	
8030503000	53		3000	38	4,010	1	-	

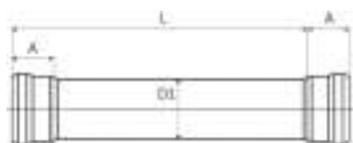
B 100 101

803

TUBO CON DUE BICCHIERI

- PIPE WITH TWO SOCKETS
- ROHR MIT ZWEI MUFFEN
- TUYAU AVEC DEUX EMBOITURES
- TUBO CON DOS MANGUITOS

MATERIAL: AISI 316L - 1.4404
GASKET: EPDM cod. 826/GV (Ø 40 ÷ 65)
 EPDM cod. 826/G (Ø 80 ÷ 150)
NORM: EN 1124-3

CODE	DN	D1 mm	L mm	A mm	kg		€
8030650250	65	73	250	55	0,760	1	-
8030650500		73	500	55	1,330	1	-
8030650750		73	750	55	1,880	1	-
8030651000		73	1000	55	2,450	1	-
8030651500		73	1500	55	3,560	1	-
8030652000		73	2000	55	4,700	1	-
8030652500		73	2500	55	5,820	1	-
8030653000	80	73	3000	55	6,950	1	-
8030800750		88,9	750	60	2,300	1	-
8030801000		88,9	1000	60	3,000	1	-
8030801500		88,9	1500	60	4,360	1	-
8030802000		88,9	2000	60	5,780	1	-
8030802500		88,9	2500	60	7,110	1	-
8030803000		88,9	3000	60	8,480	1	-
8031000750	100	102	750	70	2,670	1	-
8031001000		102	1000	70	3,500	1	-
8031001500		102	1500	70	5,050	1	-
8031002000		102	2000	70	6,600	1	-
8031002500		102	2500	70	8,180	1	-
8031003000		102	3000	70	9,750	1	-
8031250750	125	133	750	75	4,200	1	-
8031251000		133	1000	75	5,400	1	-
8031251500		133	1500	75	7,900	1	-
8031252000		133	2000	75	10,350	1	-
8031252500		133	2500	75	12,950	1	-
8031253000	133	3000	75	15,300	1	-	
8031500750	150	159	750	80	5,000	1	-
8031501000		159	1000	80	6,500	1	-
8031501500		159	1500	80	9,500	1	-
8031502000		159	2000	80	12,450	1	-
8031502500		159	2500	80	15,400	1	-
8031503000		159	3000	80	18,350	1	-

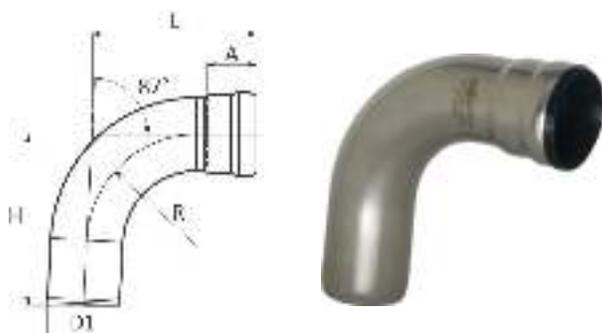
**804/87****B 100 102****CURVA 87°**

- ELBOW 87°
- ROHRBOGEN 87°
- COUDE 87°
- CURVA 87°

MATERIAL: AISI 316L - 1.4404**GASKET:** EPDM cod. 826/GV (Ø 40 ÷ 65)

EPDM cod. 826/G (Ø 80)

NORM: EN 1124-3

CODE	DN	D1 mm	L mm	A mm	H mm	R mm			€
804040087	40	42	102	30	105	63	0,193	1	-
804050087	50	53	130	38	133	80	0,310	1	-
804065087	65	73	172	55	176	110	0,700	1	-
804080087	80	88,9	199	60	204	133	1,180	1	-

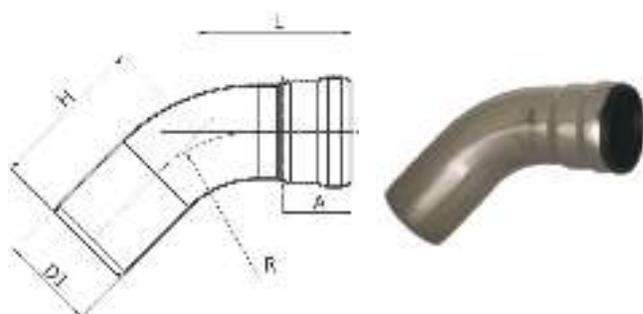
**804/45****B 100 102****CURVA 45°**

- ELBOW 45°
- ROHRBOGEN 45°
- COUDE 45°
- CURVA 45°

MATERIAL: AISI 316L - 1.4404**GASKET:** EPDM cod. 826/GV (Ø 40 ÷ 65)

EPDM cod. 826/G (Ø 80)

NORM: EN 1124-3

CODE	DN	D1 mm	L mm	A mm	H mm	R mm			€
804040045	40	42	68	30	71	63	0,146	1	-
804050045	50	53	85	38	88	80	0,229	1	-
804065045	65	73	112	55	117	110	0,521	1	-
804080045	80	88,9	128	60	133	133	0,864	1	-

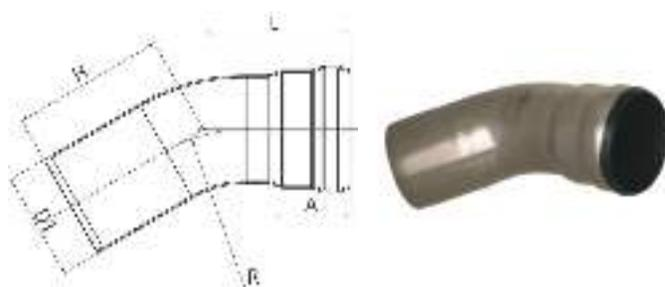
**804/30****B 100 102****CURVA 30°**

- ELBOW 30°
- ROHRBOGEN 30°
- COUDE 30°
- CURVA 30°

MATERIAL: AISI 316L - 1.4404**GASKET:** EPDM cod. 826/GV (Ø 40 ÷ 65)

EPDM cod. 826/G (Ø 80)

NORM: EN 1124-3

CODE	DN	D1 mm	L mm	A mm	H mm	R mm			€
804040030	40	42	59	30	62	63	0,129	1	-
804050030	50	53	73	38	76	80	0,201	1	-
804065030	65	73	98	55	102	110	0,462	1	-
804080030	80	88,9	109	60	114	133	0,752	1	-

B 100 102

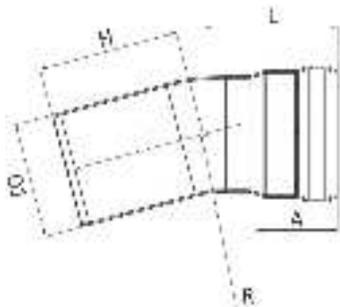

804/15

CURVA 15°

- ELBOW 15°
- ROHRBOGEN 15°
- COUDE 15°
- CURVA 15°

MATERIAL: AISI 316L - 1.4404
GASKET: EPDM cod. 826/GV (Ø 40 ÷ 65)
 EPDM cod. 826/G (Ø 80)
NORM: EN 1124-3

CODE	DN	D1 mm	L mm	A mm	H mm	R mm	kg		€
804040015	40	42	51	30	54	63	0,114	1	-
804050015	50	53	62	38	65	80	0,173	1	-
804065015	65	73	82	55	86	110	0,393	1	-
804080015	80	88,9	90	60	95	133	0,632	1	-

B 100 102

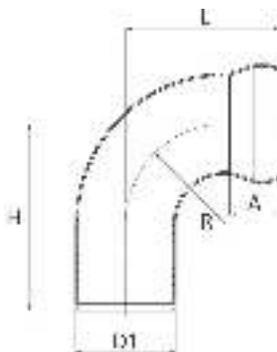

805/T

CURVA TECNICA 87°

- TECHNICAL ELBOW 87°
- TECHNISCHE ROHRBOGEN 87°
- COUDE TECHNIQUE 87°
- CURVA TÉCNICA 87°

MATERIAL: AISI 316L - 1.4404
GASKET: EPDM cod. 826/G (Ø 40 ÷ 50)
 cod. 826/GV (Ø 65)
NORM: EN 1124-3

CODE	DN	D1 mm	L mm	A mm	H mm	R mm	kg		€
805040000	40	42	64	20	79	42	0,159	1	-
805050000	50	53	81,5	26	98,5	53	0,252	1	-
805065000	65	73	127	55	142	73	0,720	1	-

B 100 102

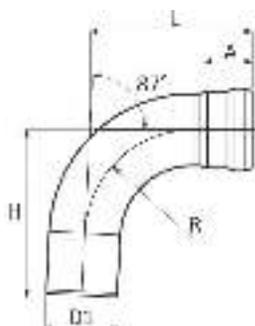

805/87

CURVA RAGGIO STRETTO 87°

- ELBOW S.R. 87°
- ROHRBOGEN KURZE RADIUS 87°
- COUDE RAYON COURT 87°
- CURVA RADIO ESTRECHO 87°

MATERIAL: AISI 316L - 1.4404
GASKET: EPDM cod. 826/GV (Ø 40 ÷ 65)
 EPDM cod. 826/G (Ø 80 ÷ 150)
NORM: EN 1124-3

CODE	DN	D1 mm	L mm	A mm	H mm	R mm	kg		€
805040087	40	42	85	30	88	42	0,199	1	-
805050087	50	53	103	38	106	53	0,302	1	-
805065087	65	73	138	55	142	73	0,693	1	-
805080087	80	88,9	157	60	162	88,9	0,955	1	-
805100087	100	102	180	70	186	102	1,258	1	-
805125087	125	133	216	75	222	133	1,959	1	-
805150087	150	159	235	80	240	159	2,510	1	-

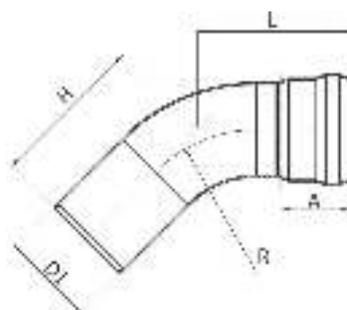
**805/45****B 100 102****CURVA RAGGIO STRETTO 45°**

- ELBOW S.R. 45°
- ROHRBOGEN KURZE RADIUS 45°
- COUDE RAYON COURT 45°
- CURVA RADIO ESTRECHO 45°

MATERIAL: AISI 316L – 1.4404**GASKET:** EPDM cod. 826/GV (Ø 40 ÷ 65)

EPDM cod. 826/G (Ø 80 ÷ 150)

NORM: EN 1124-3

CODE	DN	D1 mm	L mm	A mm	H mm	R mm			€
805040045	40	42	60	30	63	42	0,156	1	-
805050045	50	53	74	38	77	53	0,241	1	-
805065045	65	73	98	55	102	73	0,549	1	-
805080045	80	88,9	109	60	114	88,9	0,744	1	-
805100045	100	102	124	70	126	102	0,958	1	-
805125045	125	133	147	75	154	133	1,502	1	-
805150045	150	159	159	80	147	159	1,825	1	-

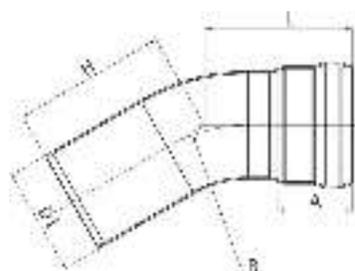
**805/30****B 100 102****CURVA RAGGIO STRETTO 30°**

- ELBOW S.R. 30°
- ROHRBOGEN KURZE RADIUS 30°
- COUDE RAYON COURT 30°
- CURVA RADIO ESTRECHO 30°

MATERIAL: AISI 316L – 1.4404**GASKET:** EPDM cod. 826/GV (Ø 40 ÷ 65)

EPDM cod. 826/G (Ø 100 ÷ 150)

NORM: EN 1124-3

CODE	DN	D1 mm	L mm	A mm	H mm	R mm			€
805100030	100	102	110	70	115	102	0,877	1	-
805125030	125	133	125	75	131	133	1,298	1	-
805150030	150	159	136	80	124	159	1,580	1	-

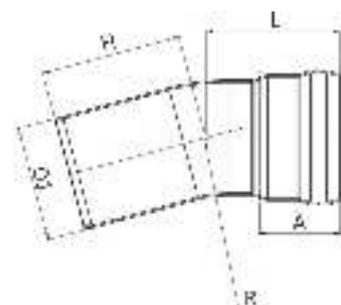
**805/15****B 100 102****CURVA RAGGIO STRETTO 15°**

- ELBOW S.R. 15°
- ROHRBOGEN KURZE RADIUS 15°
- COUDE RAYON COURT 15°
- CURVA RADIO ESTRECHO 15°

MATERIAL: AISI 316L – 1.4404**GASKET:** EPDM cod. 826/G (Ø 100 ÷ 150)**NORM:** EN 1124-3

CODE	DN	D1 mm	L mm	A mm	H mm	R mm			€
805100015	100	102	96	70	101	102	0,877	1	-
805125015	125	133	107	75	112	133	1,100	1	-
805150015	150	159	114	80	102	159	1,331	1	-

B 100 102

806

DISASSAMENTO 75/130/200 MM

- OFFSET 75/130/200 MM
- ETAGENBOGEN 75/130/200 MM
- DÉSAXEMENT 75/130/200 MM
- CURVA DESVIACIÓN 75/130/200 MM

MATERIAL: AISI 316L - 1.4404
GASKET: EPDM cod. 826/GV (Ø 65)
 EPDM cod. 826/G (Ø 80 ÷ 125)
NORM: EN 1124-3

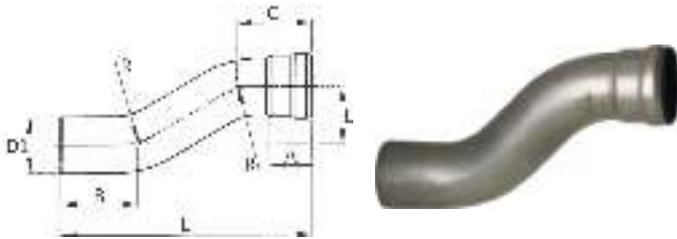

CODE	DN	D1 mm	E mm	L mm	A mm	B mm	C mm	R mm	kg	€
806065075	65	73	75	329	55	101	98	110	0,950	-
806080075	80	88,9	75	352	60	114	109	133	1,000	-
806100075	100	102	75	321	70	126	120	102	1,200	-
806125075	125	133	75	375,5	75	154	146,5	133	1,996	-
806065130	65	73	130	359	55	117	113	110	0,880	-
806080130	80	88,9	130	390	60	133	127	133	1,350	-
806100130	100	102	130	376	70	126	120	102	1,520	-
806125130	125	133	130	430,5	75	154	146,5	133	2,381	-
806065200	65	73	200	430	55	117	113	110	1,120	-
806080200	80	88,9	200	460	60	133	127	133	1,550	-
806100200	100	102	200	446	70	126	120	102	1,780	-
806125200	125	133	200	500,5	75	154	146,5	133	2,870	-

B 100 102

807

CURVA PROLUNGATA

- STREMLINE BEND
- LANG ROHRBOGEN
- COUDE PROLONGÉE
- CURVA EXTENDIDA

GASKET: EPDM cod. 826/G (Ø 80 ÷ 125)
MATERIAL: AISI 316L - 1.4404
NORM: EN 1124-3

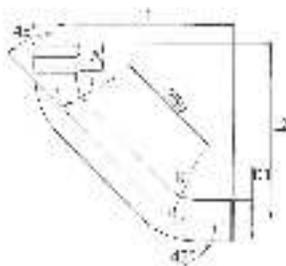

Articolo speciale a richiesta.
Special code on demand.

CODE	DN	D1 mm	L1 mm	L2 mm	A mm	R mm	kg	€
807080000	80	88,9	388	383	60	133	1,850	-
807100000	100	102	362,5	356,5	70	102	2,100	-
807125000	125	133	414	407	75	133	3,292	-

B 100 102

807/R

GOMITO RIDOTTO 87°

- REDUCED ELBOW 87°
- REDUZIERTE ROHRBOGEN 87°
- COUDE RÉDUIT 87°
- CURVA REDUCIDA 87°

MATERIAL: AISI 316L - 1.4404
GASKET: EPDM cod. 826/GV (Ø 50 ÷ 65)
NORM: EN 1124-3

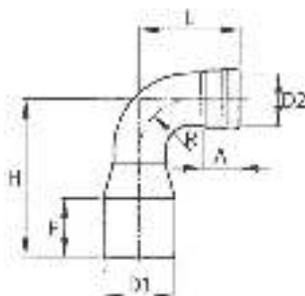

Articolo speciale a richiesta.
Special code on demand.

CODE	DN1	DN2	D1 mm	D2 mm	A mm	L mm	H mm	F mm	R mm	kg	€
807050040	50	40	53	42	30	85	124	62	42	0,290	-
807065050	65	50	73	53	38	103	161	60	53	0,390	-

B 100 102

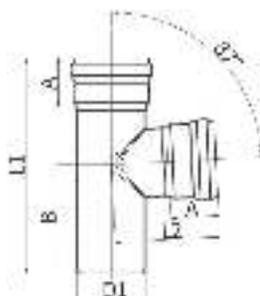
**808/87****BRAGA 87°**

- BRANCH 87°
- ABZWEIG 87°
- EMBRANCHEMENT 87°
- DERIVACIÓN M-H 87°

MATERIAL: AISI 316L – 1.4404**GASKET:** EPDM cod. 826/GV (Ø 40 ÷ 65)

EPDM cod. 826/G (Ø 80 ÷ 150)

NORM: EN 1124-3

CODE	DN	D1 mm	A mm	L1 mm	L2 mm	B mm			€
808040087	40	42	30	137	67	69,5	0,193	1	-
808050087	50	53	38	165	81	83,5	0,291	1	-
808065087	65	73	55	209	109	106	0,639	1	-
808080087	80	88,9	60	235	123	119	0,863	1	-
808100087	100	102	70	291	138	147,5	1,196	1	-
808125087	125	133	75	360	159	182	2,219	1	-
808150087	150	159	80	403	178	204	2,932	1	-

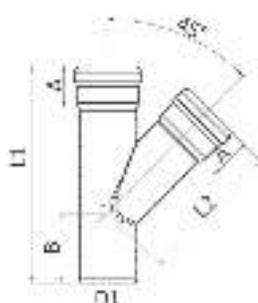
**808/45**

B 100 102

BRAGA 45°

- BRANCH 45°
- ABZWEIG 45°
- EMBRANCHEMENT 45°
- DERIVACIÓN M-H 45°

MATERIAL: AISI 316L – 1.4404**GASKET:** EPDM cod. 826/GV (Ø 40 ÷ 65)

EPDM cod. 826/G (Ø 80 ÷ 150)

NORM: EN 1124-3

CODE	DN	D1 mm	A mm	L1 mm	L2 mm	B mm			€
808040045	40	42	30	155	100	55	0,233	1	-
808050045	50	53	38	198	132,5	64	0,382	1	-
808065045	65	73	55	255	170	85	0,864	1	-
808080045	80	88,9	60	295	210	95	1,200	1	-
808100045	100	102	70	335	225	110	1,517	1	-
808125045	125	133	75	415	285	130	2,936	1	-
808150045	150	159	80	460	320	140	3,856	1	-

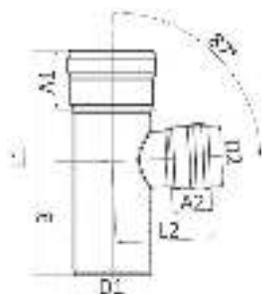
B 100 102

809
BRAGA RIDOTTA 87°

- REDUCED BRANCH 87°
- REDUZIERTE ABZWEIG 87°
- EMBRANCHEMENT RÉDUIT 87°
- DERIVACIÓN M-H REDUCIDA 87°

MATERIAL: AISI 316L - 1.4404

GASKET: EPDM cod. 826/GV (Ø 40 ÷ 65)

EPDM cod. 826/G (Ø 80 ÷ 150)

NORM: EN 1124-3

CODE	DN1	DN2	D1 mm	D2 mm	A1 mm	A2 mm	L1 mm	L2 mm	B mm	kg		€
809050040	50	40	53	42	38	30	165	73	83,5	0,269	1	-
809065040	65	40	73	42	55	30	209	83	106	0,528	1	-
809065050	65	50	73	53	55	38	209	91	106	0,547	1	-
809080050	80	50	88,9	53	60	38	235	99	119	0,726	1	-
809100040	100	40	102	42	70	30	216	97	110	0,749	1	-
809100050	100	50	102	53	70	38	226	105	115	0,800	1	-
809100065	100	65	102	73	70	55	291	123	147,5	1,092	1	-
809100080	100	80	102	88,9	70	60	291	128	147,5	1,136	1	-
809125050	125	50	133	53	75	38	294	121	149	1,551	1	-
809125065	125	65	133	73	75	55	294	139	149	1,633	1	-
809125100	125	100	133	102	75	70	294	153	149	1,723	1	-
809150065	150	65	159	73	80	55	343	152	174	2,221	1	-
809150100	150	100	159	102	80	70	343	166	174	2,308	1	-
809150125	150	125	159	133	80	75	403	172	204	2,832	1	-

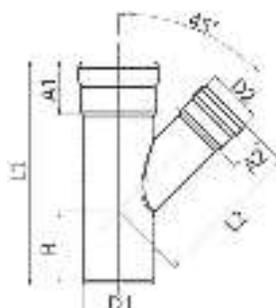
810
BRAGA RIDOTTA 45°

- REDUCED BRANCH 45°
- REDUZIERTE ABZWEIG 45°
- EMBRANCHEMENT RÉDUIT 45°
- DERIVACIÓN M-H REDUCIDA 45°

MATERIAL: AISI 316L - 1.4404

GASKET: EPDM cod. 826/GV (Ø 40 ÷ 65)

EPDM cod. 826/G (Ø 80 ÷ 150)

NORM: EN 1124-3

B 100 102

CODE	DN1	DN2	D1 mm	D2 mm	A1 mm	A2 mm	L1 mm	L2 mm	B mm	kg		€
810050040	50	40	53	42	38	30	198	147	65	0,373	1	-
810065040	65	40	73	42	55	30	205	145	60	0,563	1	-
810065050	65	50	73	53	55	38	230	155	75	0,651	1	-
810080050	80	50	88,9	53	60	38	245	173	72	0,820	1	-
810080065	80	65	88,9	73	60	55	255	180	85	0,961	1	-
810100040	100	40	102	42	70	30	250	185	65	0,916	1	-
810100050	100	50	102	53	70	38	270	195	75	1,019	1	-
810100065	100	65	102	73	70	55	300	210	95	1,257	1	-
810100080	100	80	102	88,9	70	60	320	220	100	1,408	1	-
810125050	125	50	133	53	75	38	300	225	75	1,671	1	-
810125065	125	65	133	73	75	55	330	240	90	2,236	1	-
810125100	125	100	133	102	75	70	365	260	105	2,294	1	-
810150065	150	65	159	73	80	55	330	240	90	2,314	1	-
810150100	150	100	159	102	80	70	360	281	89	2,695	1	-
810150125	150	125	159	133	80	75	420	300	120	3,358	1	-

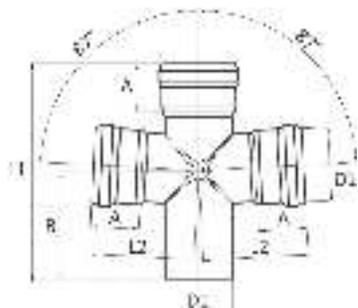
B 100 102**811/87****BRAGA DOPPIA 87°**

- DOUBLE BRANCH 87°
- DOPPELABZWEIG 87°
- EMBRANCHEMENT DOUBLE 87°
- DERIVACIÓN DOBLE M-H 87°

MATERIAL: AISI 316L – 1.4404**GASKET:** EPDM cod. 826/GV (Ø 50 ÷ 65)

EPDM cod. 826/G (Ø 100 ÷ 150)

NORM: EN 1124-3

CODE	DN	D1 mm	A mm	L1 mm	L2 mm	B mm			€
811050087	50	53	38	165	81	83,5	0,359	1	-
811065087	65	73	55	209	109	105,5	0,792	1	-
811100087	100	102	70	291	138	147,5	1,451	1	-
811125087	125	133	75	360	159	182	2,616	1	-
811150087	150	159	80	403	178	204	3,422	1	-

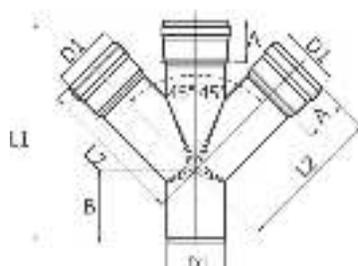
**811/45****B 100 102****BRAGA DOPPIA 45°**

- DOUBLE BRANCH 45°
- DOPPELABZWEIG 45°
- EMBRANCHEMENT DOUBLE 45°
- DERIVACIÓN DOBLE M-H 45°

MATERIAL: AISI 316L – 1.4404**GASKET:** EPDM cod. 826/GV (Ø 50 ÷ 65)

EPDM cod. 826/G (Ø 100 ÷ 150)

NORM: EN 1124-3

CODE	DN	D1 mm	A mm	L1 mm	L2 mm	B mm			€
811050045	50	53	38	198	132,5	65	0,497	1	-
811065045	65	73	55	255	170	85	1,078	1	-
811100045	100	102	70	335	225	110	1,953	1	-
811125045	125	133	75	415	285	130	3,780	1	-
811150045	150	159	80	460	320	140	4,938	1	-

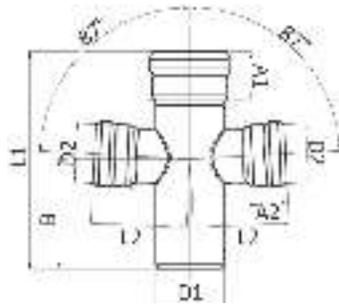

812

B 100 102

BRAGA DOPPIA RIDOTTA 87°

- REDUCED DOUBLE BRANCH 87°
- REDUZIERTE DOPPELABZWEIG 87°
- EMBRANCHEMENT DOUBLE RÉDUIT 87°
- DERIVACIÓN DOBLE M-H REDUCIDA 87°

MATERIAL: AISI 316L - 1.4404

GASKET: EPDM cod. 826/GV (Ø 40 ÷ 65)

EPDM cod. 826/G (Ø 80 ÷ 150)

NORM: EN 1124-3

CODE	DN1	DN2	D1 mm	D2 mm	A1 mm	A2 mm	L1 mm	L2 mm	B mm	kg	€
812050040	50	40	53	42	38	30	165	73	83,5	0,315	-
812065050	65	50	73	53	55	38	209	91	105,5	0,610	-
812080050	80	50	88,9	53	60	38	235	99	119	0,788	-
812100050	100	50	102	53	70	38	226	105	115	0,860	-
812100065	100	65	102	73	70	55	291	123	147,5	1,242	-
812100080	100	80	102	88,9	70	60	291	128	147,5	1,330	-
812125100	125	100	133	102	75	70	294	158	149	1,949	-
812150100	150	100	159	102	80	70	343	166	174	2,531	-
812150125	150	125	159	133	80	75	403	172	204	3,223	-

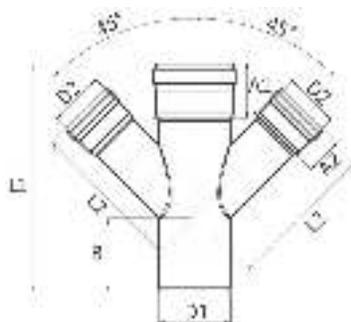

813

B 100 102

BRAGA DOPPIA RIDOTTA 45°

- REDUCED DOUBLE BRANCH 45°
- REDUZIERTE DOPPELABZWEIG 45°
- EMBRANCHEMENT DOUBLE RÉDUIT 45°
- DERIVACIÓN DOBLE M-H REDUCIDA 45°

MATERIAL: AISI 316L - 1.4404

GASKET: EPDM cod. 826/GV (Ø 40 ÷ 65)

EPDM cod. 826/G (Ø 80 ÷ 150)

NORM: EN 1124-3

CODE	DN1	DN2	D1 mm	D2 mm	A1 mm	A2 mm	L1 mm	L2 mm	B mm	kg	€
813050040	50	40	53	42	38	30	168	118	50	0,383	-
813065050	65	50	73	53	55	38	230	155	75	0,771	-
813080050	80	50	88,9	53	60	38	245	173	72	0,945	-
813100065	100	65	102	73	70	55	300	210	90	1,540	-
813100080	100	80	102	88,9	70	60	320	220	100	1,780	-
813125100	125	100	133	102	75	70	370	260	105	2,741	-
813150100	150	100	159	102	80	70	370	281	89	3,146	-
813150125	150	125	159	133	80	75	420	300	120	4,175	-

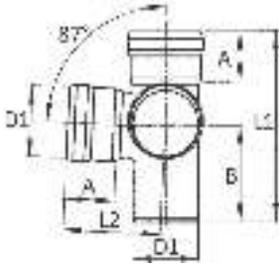
B 100 102**814/87****BRAGA SCAGNO 87°**

- CORNER BRANCH 87°
- WINKEL ABZWEIG 87°
- TÉ DOUBLE ÉQUERRE 87°
- T DOBLE ESCUADRA 87°

MATERIAL: AISI 316L – 1.4404**GASKET:** EPDM cod. 826/GV (Ø 50 ÷ 65)

EPDM cod. 826/G (Ø 80 ÷ 150)

NORM: EN 1124-3

CODE	DN	D1 mm	L1 mm	L2 mm	A mm	B mm			€
814050087	50	53	164,5	81	38	83,5	0,350	1	-
814065087	65	73	209	109	55	106	0,930	1	-
814080087	80	88,9	235	122	60	119	1,230	1	-
814100087	100	102	290,5	138	70	147	1,810	1	-
814125087	125	133	359,5	159	75	182	2,602	1	-
814150087	150	159	402,5	77,5	80	204	3,394	1	-

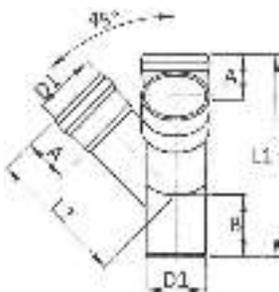

Articolo speciale a richiesta.
Special code on demand.

814/45**BRAGA SCAGNO 45°**

- CORNER BRANCH 45°
- WINKEL ABZWEIG 45°
- TÉ DOUBLE ÉQUERRE 45°
- T DOBLE ESCUADRA 45°

MATERIAL: AISI 316L – 1.4404**GASKET:** EPDM cod. 826/GV (Ø 50 ÷ 65)

EPDM cod. 826/G (Ø 80 ÷ 150)

NORM: EN 1124-3**B 100 102**

CODE	DN	D1 mm	A mm	L1 mm	L2 mm	B mm			€
814050045	50	53	38	188	123	65	0,450	1	-
814065045	65	73	55	255	170	85	1,000	1	-
814080045	80	88,9	60	295	210	95	1,450	1	-
814100045	100	102	70	335	225	110	2,400	1	-
814125045	125	133	75	415	285	130	3,757	1	-
814150045	150	159	80	460	320	140	4,902	1	-

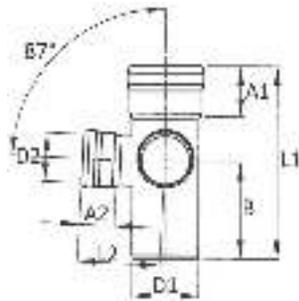

815/87

B 100 102

BRAGA SCAGNO RIDOTTA 87°

- REDUCED CORNER BRANCH 87°
- REDUZIERT WINKEL ABZWEIG 87°
- TÉ DOUBLE ÉQUERRE RÉDUIT 87°
- T DOBLE ESCUADRA REDUCIDA 87°

MATERIAL: AISI 316L - 1.4404
GASKET: EPDM cod. 826/GV (Ø 40 ÷ 65)
 EPDM cod. 826/G (Ø 80 ÷ 150)
NORM: EN 1124-3

CODE	DN1	DN2	D1 mm	D2 mm	A1 mm	A2 mm	L1 mm	L2 mm	B mm			€
815050040	50	40	53	42	38	30	164,5	72,5	83,5	0,410	1	-
815065050	65	50	73	53	55	38	209	90,5	106	0,720	1	-
815080050	80	50	88,9	53	60	38	235	98,5	119	1,160	1	-
815100065	100	65	102	73	70	55	290,5	123	147	1,440	1	-
815100080	100	80	102	88,9	70	60	290,5	128	147	1,590	1	-
815125100	125	100	133	102	75	70	293,5	153	149	1,949	1	-
815150100	150	100	159	102	80	70	342,5	166	174	2,530	1	-
815150125	150	125	159	133	80	75	402,5	195	204	3,445	1	-

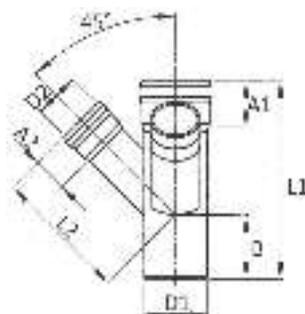

Articolo speciale a richiesta.
 Special code on demand.

816/45

B 100 102

BRAGA SCAGNO RIDOTTA 45°

- REDUCED CORNER BRANCH 45°
- REDUZIERT WINKEL ABZWEIG 45°
- TÉ DOUBLE ÉQUERRE RÉDUIT 45°
- T DOBLE ESCUADRA REDUCIDA 45°

MATERIAL: AISI 316L - 1.4404
GASKET: EPDM cod. 826/GV (Ø 40 ÷ 65)
 EPDM cod. 826/G (Ø 100 ÷ 150)
NORM: EN 1124-3

CODE	DN1	DN2	D1 mm	D2 mm	A1 mm	A2 mm	L1 mm	L2 mm	B mm			€
816050040	50	40	53	42	38	30	168	118	50	0,350	1	-
816065050	65	50	73	53	55	38	230	155	75	0,850	1	-
816100065	100	65	102	73	70	55	300	210	90	1,900	1	-
816125100	125	100	133	102	75	70	365	260	105	2,742	1	-
816150100	150	100	159	102	80	70	370	275	95	3,109	1	-
816150125	150	125	159	133	80	75	425	300	120	4,169	1	-

B 100 102

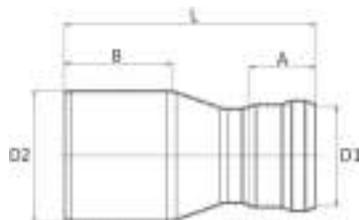
**817****RIDUZIONE CONCENTRICA**

- CONCENTRIC REDUCER
- REDUZIERSTÜCK KONZENTRISCH
- RÉDUCTION CONCENTRIQUE
- REDUCCIÓN CONCÉNTRICA

MATERIAL: AISI 316L – 1.4404**GASKET:** EPDM cod. 826/GV (Ø 40 ÷ 65)

EPDM cod. 826/G (Ø 80 ÷ 125)

NORM: EN 1124-3

CODE	DN1	DN2	D1 mm	D2 mm	A mm	L mm	B mm	kg	€	
817050040	40	50	42	53	30	120	62	0,150	1	-
817065040	40	65	42	73	30	121	60	0,234	1	-
817065050	50	65	53	73	38	140	60	0,230	1	-
817100050	50	100	53	102	38	165	87	0,500	1	-
817080065	65	80	73	88,9	55	195	80	0,475	1	-
817100065	65	100	73	102	55	184	85	0,545	1	-
817125065	65	125	73	133	55	197,5	95	0,818	1	-
817100080	80	100	88,9	102	60	190	85	0,583	1	-
817125100	100	125	102	133	70	249	85	0,833	1	-
817150100	100	150	102	159	70	247	101	1,222	1	-
817150125	125	150	133	159	75	230	95	1,308	1	-

B 100 102

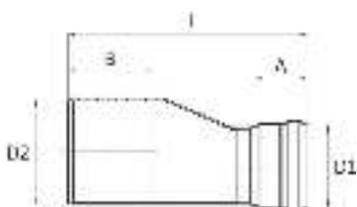
**818****RIDUZIONE ECCENTRICA**

- ECCENTRIC REDUCER
- REDUZIERSTÜCK EXZENTRISCH
- RÉDUCTION EXCENTRIQUE
- REDUCCIÓN EXCÉNTRICA

MATERIAL: AISI 316L – 1.4404**GASKET:** EPDM cod. 826/GV (Ø 40 ÷ 65)

EPDM cod. 826/G (Ø 80 ÷ 125)

NORM: EN 1124-3

CODE	DN1	DN2	D1 mm	D2 mm	A mm	L mm	B mm	kg	€	
818050040	40	50	42	53	30	125	45	0,170	1	-
818065050	50	65	53	73	38	167	70	0,322	1	-
818100050	50	100	53	102	38	197	87	0,474	1	-
818080065	65	80	73	88,9	55	187	77	0,465	1	-
818100065	65	100	73	102	55	207	87	0,590	1	-
818100080	80	100	88,9	102	60	207	87	0,635	1	-
818125100	100	125	102	133	70	239	94	1,037	1	-
818150125	125	150	133	159	75	243	101	1,382	1	-

B 100 102

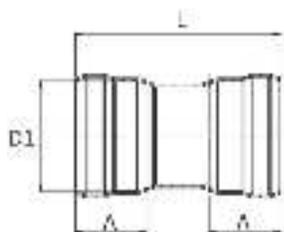

819/000

MANICOTTO

- COUPLING
- MUFFE
- MANCHON
- MANGUITO

MATERIAL: AISI 316L - 1.4404
GASKET: EPDM cod. 826/GV (Ø 40 ÷ 65)
 EPDM cod. 826/G (Ø 80 ÷ 150)
NORM: EN 1124-3

CODE	DN	D1 mm	A mm	L mm	kg		€
819040000	40	42	30	84	0,098	1	-
819050000	50	53	38	94	0,138	1	-
819065000	65	73	55	135	0,335	1	-
819080000	80	88,9	60	145	0,438	1	-
819100000	100	102	70	180	0,622	1	-
819125000	125	133	75	190	1,000	1	-
819150000	150	159	80	200	1,290	1	-

B 100 102

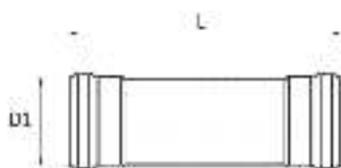

819/001

MANICOTTO PASSANTE

- SLIP COUPLING
- SCHIEBEMUFFE
- MANCHON LONG
- MANGUITO SIN TOPE

MATERIAL: AISI 316L - 1.4404
GASKET: EPDM cod. 826/G (Ø 40 ÷ 150)
NORM: EN 1124-3

CODE	DN	D1 mm	L mm	kg		€
819040001	40	42	142	0,163	1	-
819050001	50	53	176	0,251	1	-
819065001	65	73	255	0,654	1	-
819080001	80	88,9	294	0,865	1	-
819100001	100	102	334	1,130	1	-
819125001	125	133	405	2,100	1	-
819150001	150	159	473	2,960	1	-

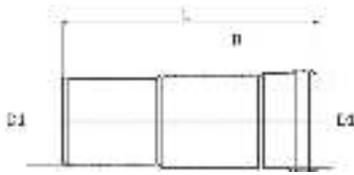
B 100 102**819/002****MANICOTTO PROLUNGATO**

- SLIDE COUPLING
- DEHNUNGSMUFFE
- MANCHON PROLONGÉE
- MANGUITO EXTENDIDO

MATERIAL: AISI 316L – 1.4404**GASKET:** EPDM cod. 826/G (Ø 40 ÷ 150)**NORM:** EN 1124-3

CODE	DN	D1 mm	B mm	L mm			€
819040002	40	42	69	120	0,132	1	-
819050002	50	53	94	155	0,214	1	-
819065002	65	73	139	205	0,486	1	-
819080002	80	88,9	134	210	0,605	1	-
819100002	100	102	148	240	0,794	1	-
819125002	125	133	158	260	1,300	1	-
819150002	150	159	168	285	1,758	1	-

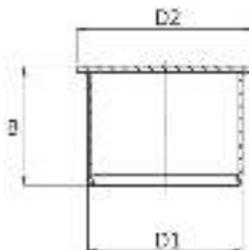
**819/003****B 100 102****TAPPO**

- STOP END
- VERSCHLUSSSTOPFEN
- BOUCHON
- TAPÓN

MATERIAL: AISI 316L – 1.4404

CODE	DN	D1 mm	D2 mm	B mm			€
819040003	40	42	50	32	0,068	1	-
819050003	50	53	60,5	40,5	0,106	1	-
819065003	65	73	80,5	57,5	0,230	1	-
819080003	80	88,9	98	62	0,317	1	-
819100003	100	102	112	72	0,420	1	-
819125003	125	133	145	77	0,634	1	-
819150003	150	159	174	82	0,854	1	-

B 100 102

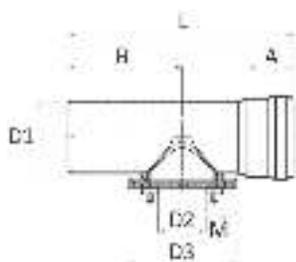

819/004

ISPEZIONE

- CLEANOUT PORT
- REVISIONSROHR
- OUVERTURE DE NETTOYAGE
- INSPECCIÓN

MATERIAL: AISI 316L - 1.4404
GASKET: EPDM cod. 826/GV (Ø 40 ÷ 65)
 EPDM cod. 826/G (Ø 80 ÷ 150)
NORM: EN 1124-3

CODE	DN	D1 mm	D2 mm	D3 mm	A mm	L mm	M	Screw Nr.	B mm	kg	€
819040004	40	42	42	70	30	142,5	M6	4	70	0,286	1 -
819050004	50	53	53	80	38	165	M6	4	84	0,380	1 -
819065004	65	73	73	105	55	225	M8	4	115	0,795	1 -
819080004	80	88,9	88,9	125	60	255	M8	4	130	1,070	1 -
819100004	100	102	88,9	125	70	291	M8	4	148	1,292	1 -
819125004	125	133	133	165	75	360	M8	8	182	2,647	1 -
819150004	150	159	133	165	80	403	M8	8	204	3,257	1 -

B 100 102

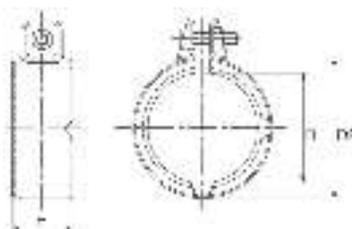

827

COLLARE ANTISFILAMENTO

- SAFETY COLLAR
- SICHERHEITSSCHELLE
- COLLIER DE SÉCURITÉ
- ABRAZADERA DE SEGURIDAD

MATERIAL: AISI 316L - 1.4404

CODE	DN	D1 mm	D2 mm	H mm	kg	€
827040000	40	42	56	27	0,120	1 -
827050000	50	53	68	31	0,150	1 -
827065000	65	73	92,5	40	0,300	1 -
827080000	80	88,9	110,5	44	0,380	1 -
827100000	100	102	124,5	53	0,500	1 -
827125000	125	133	162	58	0,687	1 -
827150000	150	159	191	63	0,860	1 -

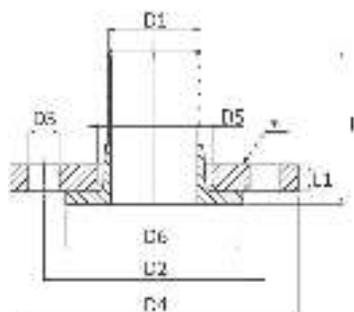
**820/PN6****B 100 102****BOCCELLO CON FLANGIA GIREVOLE**

- SLEEVE / ROTARY FLANGE
- LOSE-FLANSCH / AUSSEN
- BRIDE TOURNANTE / SORTIE A BRIDE
- BRIDA LOCA / TRONCO EMBRIDADO

MATERIAL: AISI 316L - 1.4404**NOTE:** [*] S235JR (Fe 360) zincata - galvanized - verzinkt - galvanisés - galvanizado**PN6**

CODE	DN	D1 mm	L mm	L1 mm	D2 mm	D3 mm	D4 mm	D5 mm	D6 mm	Holes Nr.	kg	€
820040006	40	42	70	12	100	14	130	52	80	4	1,304	-
820050006	50	53	80	12	110	14	140	64	90	4	1,544	-
820065006	65	73	100	12	130	14	160	83	110	4	1,975	-
820080006	80	88,9	110	14	150	18	190	96	128	4	3,166	-
820100006	100	102	130	14	170	18	210	113	148	4	3,805	-
820125006	125	133	150	14	200	18	240	140	178	8	4,770	-
820150006	150	159	170	14	225	18	265	166	202	8	5,516	-

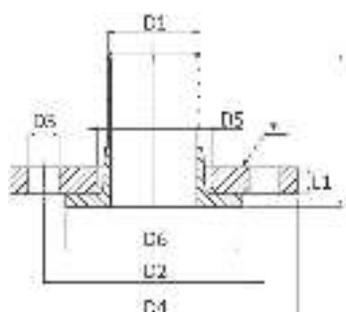
**820/PN16****B 100 102****BOCCELLO CON FLANGIA GIREVOLE**

- SLEEVE / ROTARY FLANGE
- LOSE-FLANSCH / AUSSEN
- BRIDE TOURNANTE / SORTIE A BRIDE
- BRIDA LOCA / TRONCO EMBRIDADO

MATERIAL: AISI 316L - 1.4404**NOTE:** [*] S235JR (Fe 360) zincata - galvanized - verzinkt - galvanisés - galvanizado**PN16**

CODE	DN	D1 mm	L mm	L1 mm	D2 mm	D3 mm	D4 mm	D5 mm	D6 mm	Holes Nr.	kg	€
820040010	40	42	70	16	110	18	150	52	88	4	2,181	-
820050010	50	53	80	18	125	18	165	64	102	4	2,978	-
820065010	65	73	100	18	145	18	185	83	122	4	3,659	-
820080010	80	88,9	110	20	160	18	200	96	138	8	4,580	-
820100010	100	102	130	20	180	18	220	113	158	8	5,455	-
820125010	125	133	150	22	210	18	250	140	188	8	7,377	-
820150010	150	159	170	22	240	22	285	166	212	8	9,029	-

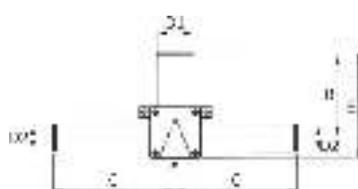

Articolo speciale a richiesta.
Special code on demand.

820/I**B 100 102****BRAGA RIDOTTA CON ISPEZIONE**

- REDUCED BRANCH WITH CLEANOUT
- REDUZIERTER BRANCH / INSPEKTION
- EMBRANCHEMENT RÉDUIT / INSPECTION
- DERIVACIÓN REDUCIDA / INSPECCIÓN

MATERIAL: AISI 316L - 1.4404

CODE	DN1	DN2	D1 mm	D2 mm	B mm	C mm	E mm	kg	€
820205000	65	50	73	53	165	240	205	2,120	-
820260000	65	50	73	53	220	240	260	2,280	-

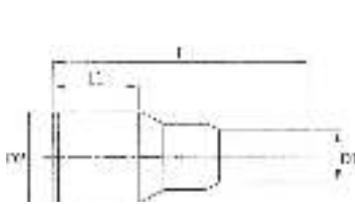

Articolo speciale a richiesta.
Special code on demand.

820/R

B 100 102

RIDUZIONE L=1000 MM

- REDUCER WITHOUT SOCKET L=1000 MM
- REDUZIERSTÜCK A-A L=1000 MM
- RÉDUCTION L=1000 MM
- REDUCCIÓN L=1000 MM

MATERIAL: AISI 316L - 1.4404

CODE	D1 mm	D2 mm	L mm	L1 mm	kg		€
820065040	42	73	1000	70	1,336	1	-

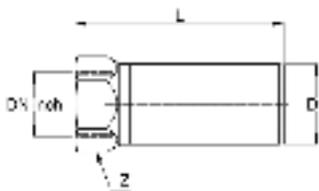

820/F

B 100 102

RACCORDO FILETTATO FEMMINA

- FEMALE THREADED CONNECTOR
- ÜBERGANGSSTÜCK MIT IG
- RACCORD FILETÉ FEMELLE
- RACOR ROSCA HEMBRA

MATERIAL: AISI 316L - 1.4404

CODE	DN	D1 mm	DN inch	L mm	Z mm	kg		€
820040100	40	42	1"	140	46	0,290	1	-
820040114	40	42	1"1/4	140	46	0,270	1	-
820040112	40	42	1"1/2	140	55	0,390	1	-
820050114	50	53	1"1/4	140	55	0,440	1	-
820050112	50	53	1"1/2	140	55	0,370	1	-
820050200	50	53	2"	140	70	0,660	1	-

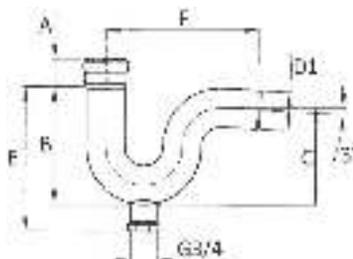

820/S

B 100 102

SIFONE

- TRAP
- SYPHON
- SIPHON
- SIFÓN

MATERIAL: AISI 316L - 1.4404
GASKET: EPDM cod. 826/GV (Ø 40 ÷ 50)
NORM: EN 1124-3

CODE	DN	D1 mm	A mm	B mm	C mm	E mm	F mm	kg		€
820040000	40	42	30	128	105	162	172	0,700	1	-
820050000	50	53	38	161	132,5	198	212	0,990	1	-

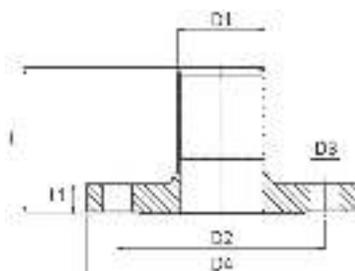
**821/PN6****B 100 102****FLANGIA CON RACCORDO MASCHIO PN6**

- FLANGE WITH SPIGOT PN6
- FLANSCHADAPTER / AUSSEN PN6
- BRIDE DE RACCORD / MALE PN6
- BRIDA ADAPTADOR / MACHO PN6

PN 6**MATERIAL:** AISI 316L - 1.4404

CODE	DN	D1 mm	L mm	L1 mm	D2 mm	D3 mm	D4 mm	Holes Nr.			€
821040006	40	42	70	14	100	14	130	4	1,301	1	-
821050006	50	53	78,5	14	110	14	140	4	1,475	1	-
821065006	65	73	97,5	14	130	14	160	4	1,897	1	-
821080006	80	88,9	105	16	150	18	190	4	2,979	1	-
821100006	100	102	115	16	170	18	210	4	3,497	1	-
821125006	125	133	116	10	200	18	240	8	2,792	1	-
821150006	150	159	122	10	225	18	265	8	3,245	1	-

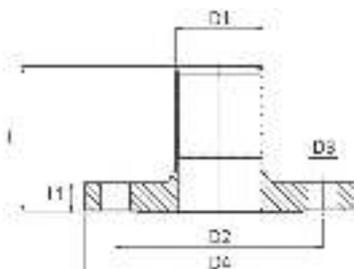
**821/PN16****B 100 102****FLANGIA CON RACCORDO MASCHIO**

- FLANGE WITH SPIGOT
- FLANSCHADAPTER / AUSSEN
- BRIDE DE RACCORD / MALE
- BRIDA ADAPTADOR / MACHO

MATERIAL: AISI 316L - 1.4404**PN 16**

CODE	DN	D1 mm	L mm	L1 mm	D2 mm	D3 mm	D4 mm	Holes Nr.			€
821040010	40	42	72	16	110	18	150	4	1,968	1	-
821050010	50	53	82,5	18	125	18	165	4	2,650	1	-
821065010	65	73	101,5	18	145	18	185	4	3,270	1	-
821080010	80	88,9	109	20	160	18	200	8	3,995	1	-
821100010	100	102	119	20	180	18	220	8	4,670	1	-
821125010	125	133	118	12	210	18	250	8	3,625	1	-
821150010	150	159	125	12	240	22	285	8	4,482	1	-

B 100 102

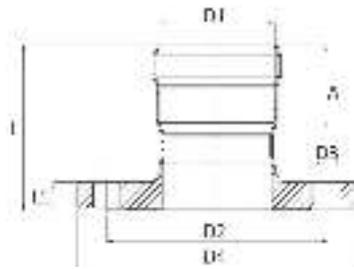

822/PN6

FLANGIA CON RACCORDO FEMMINA PN6

- FLANGE WITH SOCKET PN6
- FLANSCHADAPTER / INNEN PN6
- BRIDE DE RACCORD / FEMELLE PN6
- BRIDA ADAPTADOR / HEMBRA PN6

MATERIAL: AISI 316L - 1.4404
GASKET: EPDM cod. 826/GV (Ø 40 ÷ 65)
 EPDM cod. 826/G (Ø 80 ÷ 150)
NORM: EN 1124-3

PN 6

CODE	DN	D1 mm	A mm	L mm	L1 mm	D2 mm	D3 mm	D4 mm	Holes Nr.	kg		€
822040006	40	42	30	67	14	100	14	130	4	1,304	1	-
822050006	50	53	38	75	14	110	14	140	4	1,477	1	-
822065006	65	73	55	104	14	130	14	160	4	1,931	1	-
822080006	80	88,9	60	100	16	150	18	190	4	2,986	1	-
822100006	100	102	70	125	16	170	18	210	4	3,563	1	-
822125006	125	133	75	112	10	200	18	240	8	2,815	1	-
822150006	150	159	80	117,5	10	225	18	265	8	3,270	1	-

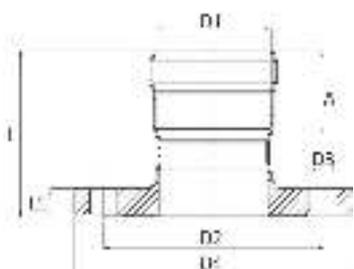

822/PN16

FLANGIA CON RACCORDO FEMMINA

- FLANGE WITH SOCKET
- FLANSCHADAPTER / INNEN
- BRIDE DE RACCORD / FEMELLE
- BRIDA ADAPTADOR / HEMBRA

MATERIAL: AISI 316L - 1.4404
GASKET: EPDM cod. 826/GV (Ø 40 ÷ 65)
 EPDM cod. 826/G (Ø 80 ÷ 150)
NORM: EN 1124-3

PN 16

B 100 102

CODE	DN	D1 mm	A mm	L mm	L1 mm	D2 mm	D3 mm	D4 mm	Holes Nr.	kg		€
822040010	40	42	30	69	16	110	18	150	4	1,972	1	-
822050010	50	53	38	79	18	125	18	165	4	2,653	1	-
822065010	65	73	55	108	18	145	18	185	4	3,301	1	-
822080010	80	88,9	60	104	20	160	18	200	8	4,000	1	-
822100010	100	102	70	129	20	180	18	220	8	4,736	1	-
822125010	125	133	75	114	12	210	18	250	8	3,648	1	-
822150010	150	159	80	119,5	12	240	22	285	8	4,504	1	-

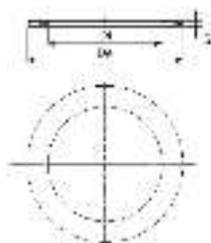
**434/PN 6****R 30 30****GUARNIZIONE ECOLOGICA PER FLANGE**

- GASKET FOR FLANGE
- FLANSCHDICHTUNG
- JOINT POUR BRIDE
- JUNTA ECOLÓGICA PARA BRIDA

PN 6
MATERIAL: Sesalit Eco
NORM: EN 1092-1

CODE	DN	De mm	Di mm	S mm			€
434040006	40 - [1"1/2]	85	45	2	14	10	-
434050006	50 - [2"]	95	57	2	15	10	-
434065006	65 - [2"1/2]	115	76	2	19	10	-
434080006	80 - [3"]	132	89	2	26	10	-
434100006	100 - [4"]	152	108	2	29	10	-
434125006	125 - [5"]	182	133	2	41	10	-
434150006	150 - [6"]	207	160	2	38	10	-

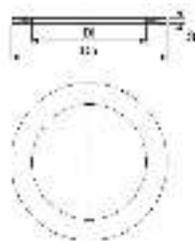
**434/PN 10-16****R 30 30****GUARNIZIONE ECOLOGICA PER FLANGE**

- GASKET FOR FLANGE
- FLANSCHDICHTUNG
- JOINT POUR BRIDE
- JUNTA ECOLÓGICA PARA BRIDA

PN 10/16
MATERIAL: Sesalit Eco
NORM: EN 1092-1

CODE	DN	De mm	Di mm	S mm			€
434040000	40 - [1"1/2]	92	45	2	17	10	-
434050000	50 - [2"]	108	57	2	22	10	-
434065000	65 - [2"1/2]	127	76	2	27	10	-
434080000	80 - [3"]	142	89	2	30	10	-
434100000	100 - [4"]	162	108	2	38	10	-
434125000	125 - [5"]	192	140	2	44	10	-
434150000	150 - [6"]	218	169	2	55	10	-

Sesalit ECO: fibre organiche e sintetiche legate con gomma NBR/SBR esente amianto

IMPIEGHI: Acqua calda e fredda, olii vegetali ed animali, aria, alcuni carburanti (no GAS)
LIMITI DI TEMPERATURA ORIENTATIVI

Temperatura massima per brevi esposizioni: 180°-200° C

Temperatura massima di esercizio continuo per fluidi non aggressivi: 140° C

Temperatura massima di esercizio continuo con vapore: 110° C

OMOLOGAZIONI: acqua potabile WRAS n° 1605525

Sesalit ECO: organic and synthetic fibers bonded with NBR/SBR asbestos-free

USES: hot and cold water, vegetable and animal oils, air, some fuels (no GAS)
GUIDELINE TEMPERATURE LIMITS

Maximum temperature for short exposure: 180°-200° C

Maximum operating temperature for continuous non-aggressive fluids: 140° C

Maximum temperature for continuous operation with steam: 110° C

APPROVAL: potable water WRAS n° 1605525

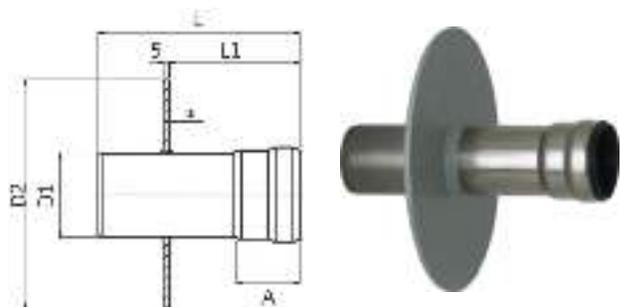
B 100 102

823/F1

PASSAGGIO STAGNO F1

- DECK / BULKHEAD PENETRATION F1
- WANDDURCHFÜHRUNG F1
- PASSAGE ÉTANCHE F1
- PASAJE ESTAÑO F1

MATERIAL: AISI 316L - 1.4404

NOTE: [*] S235JR (Fe 360) verniciato - painted - bemalt - peint - pintado
 EPDM cod. 826/GV (Ø 40 ÷ 65)

GASKET: EPDM cod. 826/G (Ø 80 ÷ 150)

NORM: EN 1124-3

CODE	DN	D1 mm	L mm	L1 mm	D2 mm	A mm	kg	€
823040000	40	42	161	93	200	30	1,345	-
823050000	50	53	202	118	200	38	1,410	-
823065000	65	73	279	165	200	55	1,470	-
823080000	80	88,9	332	194	200	60	1,510	-
823100000	100	102	381	223	200	70	2,130	-
823125000	125	133	479	275	250	75	3,775	-
823150000	150	159	562	319	250	80	4,511	-

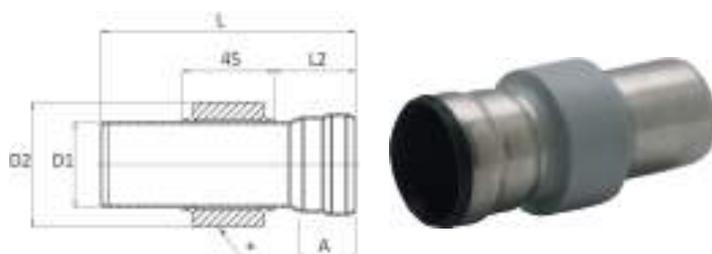
B 100 102

823/M1

PASSAGGIO STAGNO M1

- DECK / BULKHEAD PENETRATION M1
- WANDDURCHFÜHRUNG M1
- PASSAGE ÉTANCHE M1
- PASAJE ESTAÑO M1

MATERIAL: AISI 316L - 1.4404

NOTE: [*] S235JR (Fe 360) verniciato - painted - bemalt - peint - pintado
 EPDM cod. 826/GV (Ø 40 ÷ 65)

GASKET: EPDM cod. 826/G (Ø 80 ÷ 150)

NORM: EN 1124-3

CODE	DN	D1 mm	L mm	L2 mm	D2 mm	A mm	kg	€
823040001	40	42	125	40	61	30	0,533	-
823050001	50	53	145	50	70	38	0,612	-
823065001	65	73	175	65	88,9	55	0,926	-
823080001	80	88,9	185	70	110	60	1,394	-
823100001	100	102	205	80	121	70	1,501	-
823125001	125	133	215	85	150	75	1,979	-
823150001	150	159	225	90	178	80	2,613	-

B 100 102

**823/M2****PASSAGGIO STAGNO M2**

- DECK / BULKHEAD PENETRATION M2
- WANDDURCHFÜHRUNG M2
- PASSAGE ÉTANCHE M2
- PASAJE ESTAÑO M2

MATERIAL: AISI 316L - 1.4404**NOTE:** [*] S235JR (Fe 360) verniciato - painted - bemalt - peint - pintado**GASKET:** EPDM cod. 826/GV (Ø 40 ÷ 65)
EPDM cod. 826/G (Ø 80 ÷ 150)**NORM:** EN 1124-3

CODE	DN	D1 mm	L mm	D2 mm	A mm			€
823040002	40	42	108	62,5	30	0,485	1	-
823050002	50	53	125	75	38	0,645	1	-
823065002	65	73	155	101	55	1,180	1	-
823080002	80	88,9	178	113,5	60	1,200	1	-
823100002	100	102	198	133	70	1,760	1	-
823125002	125	133	245	168	75	2,773	1	-
823150002	150	159	284	193	80	3,116	1	-

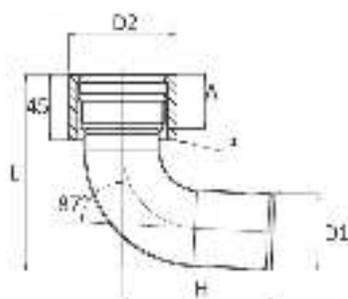
**823/M3****PASSAGGIO STAGNO M3**

- DECK / BULKHEAD PENETRATION M3
- WANDDURCHFÜHRUNG M3
- PASSAGE ÉTANCHE M3
- PASAJE ESTAÑO M3

MATERIAL: AISI 316L - 1.4404**NOTE:** [*] S235JR (Fe 360) verniciato - painted - bemalt - peint - pintado**GASKET:** EPDM cod. 826/GV (Ø 40 ÷ 65)
EPDM cod. 826/G (Ø 80 ÷ 100)**NORM:** EN 1124-3

CODE	DN	D1 mm	L mm	D2 mm	H mm	A mm			€
823040003	40	42	110,5	62,5	88	30	0,564	1	-
823050003	50	53	135	75	106	38	0,771	1	-
823065003	65	73	182	101	142	55	1,510	1	-
823080003	80	88,9	210	113,5	162	60	1,485	1	-
823100003	100	102	240	133	186	70	2,365	1	-

B 100 102

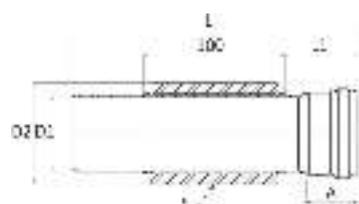

823/M4

PASSAGGIO STAGNO M4

- DECK / BULKHEAD PENETRATION M4
- WANDDURCHFÜHRUNG M4
- PASSAGE ÉTANCHE M4
- PASAJE ESTAÑO M4

MATERIAL: AISI 316L - 1.4404
NOTE: [*] S235JR [Fe 360] verniciato - painted - bemalt - peint - pintado
GASKET: EPDM cod. 826/GV (Ø 40 ÷ 65)
 EPDM cod. 826/G (Ø 80 ÷ 150)
NORM: EN 1124-3

CODE	DN	D1 mm	L mm	L1 mm	D2 mm	A mm	kg		€
823040004	40	42	180	40	61	30	1,195	1	-
823050004	50	53	200	50	70	38	1,320	1	-
823065004	65	73	230	65	88,9	55	1,820	1	-
823080004	80	88,9	240	70	110	60	2,835	1	-
823100004	100	102	260	80	121	70	2,895	1	-
823125004	125	133	270	85	150	75	3,462	1	-
823150004	150	159	280	90	178	80	4,675	1	-

B 100 102

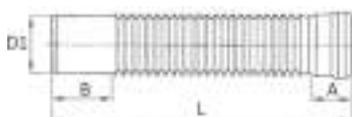

824/G

FLESSIBILE PER SCARICHI / GRAVITÀ

- FLEXIBLE PIPE FOR DRAINS / GRAVITY
- FLEXIBEL ROHR / SCHWERKRAFT
- TUYAU FLEXIBLE / GRAVITÉ
- TUBO FLEXIBLE / GRAVITACIÓN

MATERIAL: AISI 316L - 1.4404
GASKET: EPDM cod. 826/GV (Ø 50)
NORM: EN 1124-3

CODE	DN	D1 mm	A mm	L mm	B mm	kg		€
8240500600	50	53	38	600	55	0,780	1	-
8240500750	50	53	38	750	55	0,960	1	-
8240501000	50	53	38	1000	55	1,260	1	-
8240501250	50	53	38	1250	55	1,550	1	-

B 100 102

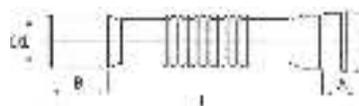

824/V

FLESSIBILE PER SCARICHI / VUOTO

- FLEXIBLE PIPE FOR DRAINS / VACUUM
- FLEXIBEL ROHR / VAKUUM
- TUYAU FLEXIBLE / VIDE
- TUBO FLEXIBLE / VACÍO

MATERIAL: AISI 316L - 1.4404
GASKET: EPDM cod. 826/GV (Ø 50)
NORM: EN 1124-3

CODE	DN	D1 mm	A mm	L mm	B mm	kg		€
8240501100	50	53	38	1100	62	1,000	1	-
8240501500	50	53	38	1500	62	1,270	1	-
8240502000	50	53	38	2000	62	1,630	1	-
8240502500	50	53	38	2500	62	1,980	1	-

B 100 102

825/01**POZZETTO CON FLANGIA / ATTACCO ORIZZONTALE**

- SCUPPER WITH FLANGE / HORIZONTAL OUTLET
- BODENABLAUF MIT FLANSCH / HORIZONTAL ABGANG
- BONDE AVEC BRIDE / LATÉRAL
- DESAGÜE CON BRIDA / LATERAL

MATERIAL: AISI 316L - 1.4404**NOTE:** Senza sifone - Without siphon - Ohne Syphon - Sans siphon - Sin sifón

CODE	DN	D1 mm	L mm	H mm	H1 mm	D mm	D2 mm	kg	€	
825040011	40	42	125,5	124,5	92	138	200	1,800	1	-
825050011	50	53	125,5	124,5	92	138	200	1,750	1	-
825065011	65	73	142,5	124,5	88	138	200	1,800	1	-

B 100 102

825/02**POZZETTO A SALDARE / ATTACCO ORIZZONTALE**

- SCUPPER TO WELD / HORIZONTAL OUTLET
- BODENABLAUF ZU SCHWEISSEN / HORIZONTAL ABGANG
- BONDE À SOUDER / LATÉRAL
- DESAGÜE PARA SOLDAR / LATERAL

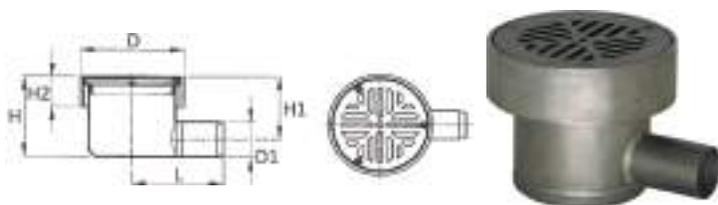
MATERIAL: AISI 316L - 1.4404**NOTE:** Senza sifone - Without siphon - Ohne Syphon - Sans siphon - Sin sifón

CODE	DN	D1 mm	L mm	H mm	H1 mm	H2 mm	D mm	kg	€	
825040022	40	42	115	124,5	92	45	150	1,750	1	-
825050022	50	53	115	134,5	102	45	150	1,750	1	-
825065022	65	73	142,5	134,5	96	45	150	1,800	1	-
825100022	100	102	157,5	153,5	102,5	45	150	2,400	1	-

B 100 102

825/03**POZZETTO CON FLANGIA / ATTACCO VERTICALE**

- SCUPPER WITH FLANGE / VERTICAL OUTLET
- BODENABLAUF MIT FLANSCH / VERTIKAL ABGANG
- BONDE AVEC BRIDE / VERTICAL
- DESAGÜE CON BRIDA / VERTICAL

MATERIAL: AISI 316L - 1.4404**NOTE:** Senza sifone - Without siphon - Ohne Syphon - Sans siphon - Sin sifón

CODE	DN	D1 mm	L mm	H mm	D mm	D2 mm	kg	€	
825040033	40	42	172	124,5	138	200	1,800	1	-
825050033	50	53	179,5	124,5	138	200	1,750	1	-
825065033	65	73	198,5	124,5	138	200	1,800	1	-

B 100 102

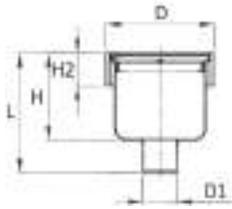

825/04

POZZETTO A SALDARE / ATTACCO VERTICALE

- SCUPPER TO WELD / VERTICAL OUTLET
- BODENABLAUF ZU SCHWEISSEN / VERTIKAL ABGANG
- BONDE À SOUDER / VERTICAL
- DESAGÜE PARA SOLDAR / VERTICAL

MATERIAL: AISI 316L - 1.4404

NOTE: Senza sifone - Without siphon - Ohne Syphon - Sans siphon - Sin sifón

CODE	DN	D1 mm	L mm	H mm	H2 mm	D mm	kg		€
825040044	40	42	179,5	124,5	45	150	1,750	1	-
825050044	50	53	189,5	134,5	45	150	1,750	1	-
825065044	65	73	208,5	134,5	45	150	1,800	1	-
825100044	100	102	223,5	134,5	45	150	2,100	1	-

B 100 102

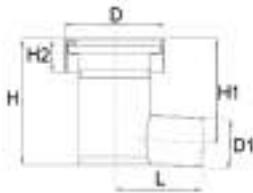

825/05

POZZETTO A SALDARE / ATTACCO ORIZZONTALE / LUNGO

- SCUPPER TO WELD / HORIZONTAL OUTLET / LONG
- BODENABLAUF ZU SCHWEISSEN / HORIZONTAL ABGANG / LANG
- BONDE À SOUDER / LATÉRAL / LONG
- DESAGÜE PARA SOLDAR / LATERAL / LARGO

MATERIAL: AISI 316L - 1.4404

NOTE: Senza sifone - Without siphon - Ohne Syphon - Sans siphon - Sin sifón

CODE	DN	D1 mm	L mm	H mm	H1 mm	H2 mm	D mm	kg		€
825040055	40	42	128,5	187	169,5	50	150	2,006	1	-
825050055	50	53	129	187	164	50	150	2,032	1	-
825065055	65	73	129,5	187	154	50	150	2,074	1	-
825100055	100	102	157	187	141	50	150	2,246	1	-

B 100 102

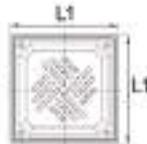

825/06 Q

POZZETTO A SALDARE / ATTACCO ORIZZONTALE / TELESCOPICO / QUADRO

- SCUPPER TO WELD / HORIZONTAL OUTLET / TELESCOPIC / SQUARE
- BODENABLAUF ZU SCHWEISSEN / HORIZONTAL ABGANG / TELESKOPISCH / QUADRAT
- BONDE À SOUDER / LATÉRAL / TÉLESCOPIQUE / CARRÉ
- DESAGÜE PARA SOLDAR / LATERAL / TELESCÓPICO / CUADRADO

MATERIAL: AISI 316L - 1.4404

NOTE: Con sifone - With siphon - Mit Syphon - Avec siphon - Con sifón

CODE	DN	D1 mm	L mm	L1 mm	H mm	H1 mm	H2 mm	H3 mm	D mm	D2 mm	kg		€
825040066Q	40	42	128,5	150	124,5	92	45	20-100	145	110	2,946	1	-
825050066Q	50	53	128,5	150	124,5	92	45	20-100	145	110	2,942	1	-
825065066Q	65	73	140	150	124,5	88	45	20-100	145	110	2,992	1	-

B 100 102

825/06 C

POZZETTO A SALDARE / ATTACCO ORIZZONTALE / TELESCOPICO / ROTONDO

- SCUPPER TO WELD / HORIZONTAL OUTLET / TELESCOPIC / ROUND
- BODENABLAUF ZU SCHWEISSEN / HORIZONTAL ABGANG / TELESKOPISCH / RUNDE
- BONDE À SOUDER / LATÉRAL / TÉLESCOPIQUE / ROND
- DESAGÜE PARA SOLDAR / LATERAL / TELESCÓPICO / REDONDO

MATERIAL: AISI 316L - 1.4404

NOTE: Con sifone - With siphon - Mit Syphon - Avec siphon - Con sifón

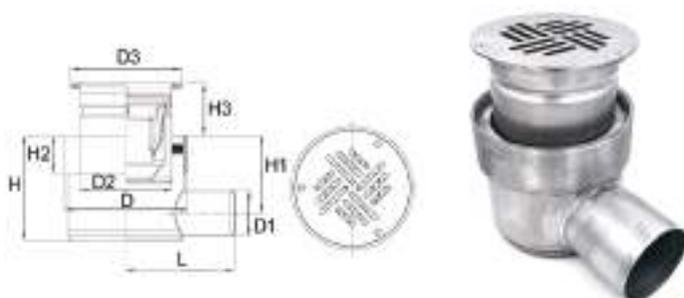

CODE	DN	D1 mm	L mm	H mm	H1 mm	H2 mm	H3 mm	D mm	D2 mm	D3 mm	kg	€
825040066C	40	42	128,5	124,5	92	45	25-90	145	110	132	2,782	1 -
825050066C	50	53	128,5	124,5	92	45	25-90	145	110	132	2,838	1 -
825065066C	65	73	140	124,5	88	45	25-90	145	110	132	2,865	1 -

B 100 102

825/07 Q

POZZETTO A SALDARE / ATTACCO VERTICALE / TELESCOPICO / QUADRO

- SCUPPER TO WELD / VERTICAL OUTLET / TELESCOPIC / SQUARE
- BODENABLAUF ZU SCHWEISSEN / VERTIKAL ABGANG / TELESKOPISCH / QUADRAT
- BONDE À SOUDER / VERTICAL / TÉLESCOPIQUE / CARRÉ
- DESAGÜE PARA SOLDAR / VERTICAL / TELESCÓPICO / CUADRADO

MATERIAL: AISI 316L - 1.4404

NOTE: Con sifone - With siphon - Mit Syphon - Avec siphon - Con sifón

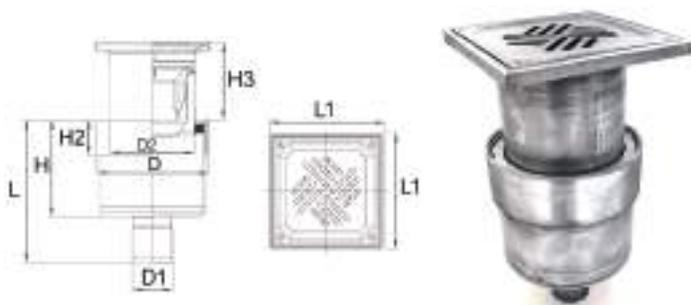

CODE	DN	D1 mm	L mm	L1 mm	H mm	H2 mm	H3 mm	D mm	D2 mm	kg	€
825040077Q	40	42	184,5	150	124,5	45	20-100	145	110	2,904	1 -
825050077Q	50	53	184,5	150	124,5	45	20-100	145	110	2,950	1 -
825065077Q	65	73	198,5	150	124,5	45	20-100	145	110	2,980	1 -

B 100 102

825/07 C

POZZETTO A SALDARE / ATTACCO VERTICALE / TELESCOPICO / ROTONDO

- SCUPPER TO WELD / VERTICAL OUTLET / TELESCOPIC / ROUND
- BODENABLAUF ZU SCHWEISSEN / VERTIKAL ABGANG / TELESKOPISCH / RUNDE
- BONDE À SOUDER / VERTICAL / TÉLESCOPIQUE / ROND
- DESAGÜE PARA SOLDAR / VERTICAL / TELESCÓPICO / REDONDO

MATERIAL: AISI 316L - 1.4404

NOTE: Con sifone - With siphon - Mit Syphon - Avec siphon - Con sifón

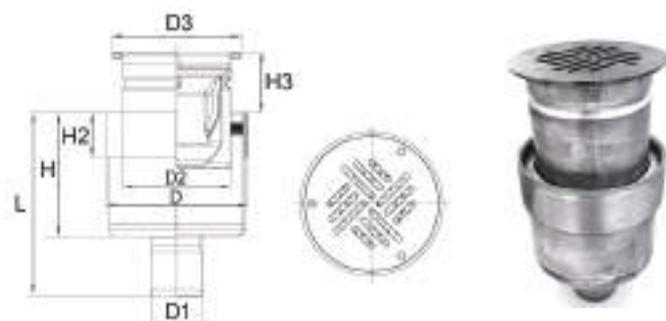

CODE	DN	D1 mm	L mm	H mm	H2 mm	H3 mm	D mm	D2 mm	D3 mm	kg	€
825040077C	40	42	184,5	124,5	45	25-90	145	110	132	2,817	1 -
825050077C	50	53	184,5	124,5	45	25-90	145	110	132	2,798	1 -
825065077C	65	73	198,5	124,5	45	25-90	145	110	132	2,848	1 -

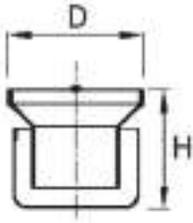

820/P

B 100 102

SIFONE PER POZZETTO DI SCARICO

- SIPHON FOR SCUPPER DRAIN
- SIPHON FÜR BODENABLAUF
- SIPHON POUR BONDE
- SIFÓN PARA DESAGÜE

MATERIAL: AISI 316L - 1.4404

NOTE: per / for / für / pour / para 825/01÷04

CODE	D mm	H mm	kg		€
820000000	106	96	0,365	1	-

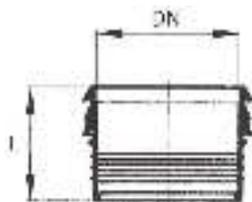
**826/GV****B 100 102****ANELLO DI TENUTA / GRAVITÀ + VUOTO**

- SEAL / GRAVITY + VACUUM
- DICHTUNG / SCHWERKRAFT + VAKUUM
- JOINT / GRAVITÉ + VIDE
- GUARNICIÓN / GRAVITACIÓN + VACÍO

MATERIAL: gomma / rubber EPDM

CODE	DN	L mm			€
826040000	40	34,5	0,010	1	-
826050000	50	42,5	0,018	1	-
826065000	65	59,5	0,035	1	-

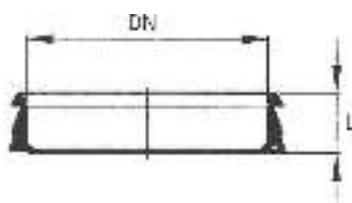
**826/G****B 100 102****ANELLO DI TENUTA / GRAVITÀ**

- SEAL / GRAVITY
- DICHTUNG / SCHWERKRAFT
- JOINT / GRAVITÉ
- GUARNICIÓN / GRAVITACIÓN

MATERIAL: gomma / rubber EPDM

CODE	DN	L mm			€
826040001	40	15	0,007	1	-
826050001	50	18	0,012	1	-
826065001	65	21	0,020	1	-
826080001	80	22,5	0,029	1	-
826100001	100	27	0,051	1	-
826125001	125	29	0,080	1	-
826150001	150	36	0,138	1	-

**826/L****B 100 102****TUBETTO LUBRIFICANTE 150 GR**

- LUBRICANT 150 GR
- SCHMIERSTOFF 150 GR
- LUBRIFIANT 150 GR
- LUBRICANTE 150 GR

CODE			€
826000002	0,150	1	-

A 50 50

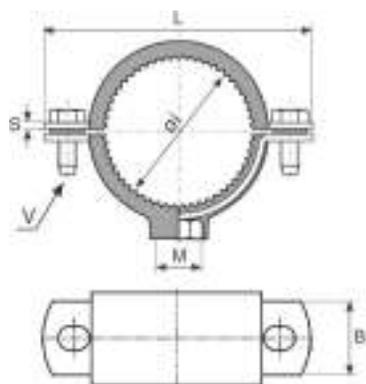

Conforme a
Conform to
Entsprechend
Correspondant
Conforme a la

DIN 4109

156/G

COLLARE CON GOMMA

- CLAMP WITH RUBBER
- ROHRSCHELLE MIT GUMMIEINLAGE
- COLLIER DE FIXATION GARNITURE ISOPHONIQUE
- ABRAZADERA ISOFÓNICA

MATERIAL: AISI 304 - 1.4301

VULCANIZED RUBBER: EPDM [-20° C/+120° C]
durezza/hardness 55 Shore

NOTE: dado saldato con puntatura elettrica
spot welded nut

CODE	Øi Drain mm	M	V mm	B mm	L mm	S mm	g	kg	Box	€
156114304G	42	M 8	M 6 x 20	20	85	2,5	120	1	50*	-
156112304G	53	M 8	M 6 x 25	20	97	2,5	142	1	50*	-
156212304G	73	M 10	M 6 x 25	30	128	2,5	308	1	10*	-
156300304G	88,9	M 10	M 6 x 25	30	148	2,5	346	1	10*	-

[*] unità minima di vendita / minimum selling quantity

A 50 51

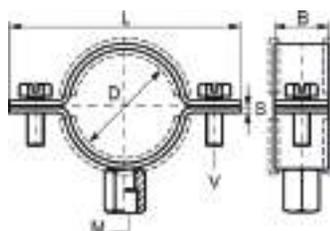

156/G

COLLARE CON GOMMA

- CLAMP WITH RUBBER
- ROHRSCHELLE MIT GUMMIEINLAGE
- COLLIER DE FIXATION GARNITURE ISOPHONIQUE
- ABRAZADERA ISOFÓNICA

MATERIAL: AISI 316 - 1.4401

VULCANIZED RUBBER: EPDM [-20° C/+120° C]

NOTE: dado saldato con puntatura elettrica
spot welded nut

CODE	Øi Drain mm	DN inch	M	V mm	B mm	L mm	S mm	g	kg	Box	€
156312316G	102	3"1/2	M 8 / 10	M 6 x 20	20	165	2	189	10*	-	
156500316G	**	5"	M 10	M 6 x 25	20	179	2,5	250	10*	-	
156600316G	**	6"	M 10	M 8 x 35	25	233	2,5	470	10*	-	

[*] unità minima di vendita / minimum selling quantity

[**] AISI 316L / 1.4404



Come ordinare

How to order



+ 39 0376 96 001



+ 39 0376 96 422



ordini.info@racmet.com



raccorderiemetalliche.com



Struttura commerciale - Sales Organisation

246 - 248



MKTG & PRODUCT MANAGER

Fabrizio PIZZAMIGLIO

Tel. +39 0376 96 02 09

Mob. +39 348 0171387

fabrizio.pizzamiglio@racmet.com

QUALITY MANAGER

Silvio POZZETTI

Tel. +39 0376 96 02 91

Mob. +39 335 7250642

silvio.pozzetti@racmet.com



TECHNICAL & SALES CONSULTANT

Matteo AVANZI

Tel. 0376 96001

Mob. +39 342 8068177

tecnico@racmet.com



CUSTOMER SERVICE

Sara BELLADELLI

Tel. +39 0376 96 001

ordini.info@racmet.com



AMMINISTRAZIONE book-keeping

Giovanni MIRONI

Tel. +39 0376 96 02 21

amministrazione@racmet.com

Seguici su Facebook, LinkedIn e Instagram

Follow us on Facebook, LinkedIn and Instagram

@raccorderiemetalliche



**Il nuovo Product Range 2021 è scaricabile
in pdf nella sezione Download del nostro
sito raccorderiemetalliche.com**

*The new Product Range 2021 can be downloaded in pdf format in
the Download section of our website raccorderiemetalliche.com*

Condividi le foto dei tuoi impianti!

SHARE PHOTOS OF YOUR PLANTS!

Hai realizzato un impianto utilizzando i nostri sistemi pressare?

Inviaci le foto e i dettagli della tua installazione

all'indirizzo mail marketing@racmet.com,

le pubblicheremo sui nostri canali web.

Did you build a system using our pressfitting systems?

Send us the photos and details of your installation

to the email address marketing@racmet.com and

we will post them on our web channels.



Raccorderie Metalliche S.p.a.

Struttura commerciale Italia Sales Organization



RESPONSABILE VENDITE ITALIA

Massimiliano GABBI

Tel. 0376 960206
Fax 0376 96422
Cell. 335 7663876
massimiliano.gabbi@racmet.com

FUNZIONARI DIRETTI RM

PIEMONTE-VALLE D'AOSTA-MN-VA-PV

Luca SALVAGNI - Funzionario Vendite
Tel. 0376 96001 - Fax 0376 96422
Cell. 335 325987
luca.salvagni@racmet.com

MI-BG-BS-LC-CO-SO-LO-MB-CR

Carlo PUGNAGHI - Funzionario Vendite
Tel. 0376 96001 - Fax 0376 96422
Cell. 335 7364515
carlo.pugnaghi@racmet.com

TRENTINO ALTO ADIGE VENETO - FRIULI VENEZIA GIULIA

Paolo MEGARESE - Funzionario Vendite
Tel. 0376 96001 - Fax 0376 96422
Cell. 345 5669878
paolo.megarese@racmet.com

MI-BG-BS-LC-CO-SO-LO-MB-CR VENETO

Matteo VISSER - Funzionario Vendite
Tel. 0376 96001 - Fax 0376 96422
Cell. 335 6907418
matteo.visser@racmet.com

EMILIA ROMAGNA - MARCHE (PU - AN)

Daniele BONACINI - Funzionario Vendite
Tel. 0376 96001 - Fax 0376 96422
Cell. 344 1174021
daniele.bonacini@racmet.com

TOSCANA

Alessio PAOLESCHI - Funzionario Vendite
Tel. 0376 96001 - Fax 0376 96422
Cell. 335 5251961
alessio.paoleschi@racmet.com

LIGURIA

Energy Team di Emerigo Francesco
Via Verdi, 20/D
18100 Imperia (IM)
Tel. 0183 279239 - Fax 0183 653445
info@energyteamliguria.it

LAZIO

RTL snc di Maramao e C.
Via Morolense, 27
03013 Ferentino (FR)
Tel. 0775 392043
info@rtletis.it

CALABRIA

Agenzia Logozzo Fausto
Via Napoli, 33 - 89042
Gioiosa Ionica (RC)
Cell. 393 9761850
info@agenziaalozzo.com



CAMPANIA

Corrado Rappresentanze sas
Via D. Fontana, 184 - 80131 Napoli (NA)
Tel. 081 5463752 - Fax 081 5464837

Salvatore CORRADO

Cell. 335 6656224
corradosas@fastwebnet.it

ABRUZZO - MOLISE - UMBRIA MARCHE (AP - FM - MC)

SCR sas di Simoncini O. & C.
Via G. Leopardi 26 - 64015 Nereto (TE)
Tel. 0861 851807 - Fax 0861 1856461

Otello SIMONCINI

Cell. 348 3859388
agenziaimoncini@gmail.com

PUGLIA - BASILICATA

F.A.R.P. srl
Viale Vittorio Emanuele II, 26
70010 Cellamare (BA)
Tel. 080 4657523 - Fax 080 4657498
agidue.alloggio@gmail.com

SICILIA OCCIDENTALE PA - TP - AG - CL

Spitaleri Rappresentanze di Spitaleri Gaetano & C. snc
Via degli Ioni, 7 - 91100 Trapani (TP)
Tel. 0923 567361 - Fax 0923 553588

Gaetano SPITALERI

Cell. 335 5389203
info@spitalerirappresentanze.it

SICILIA ORIENTALE ME - CT - SR - RG - EN

Matteo ARDIZZONE
Via Salvatore Quasimodo, 8
95030 S. Agata Li Battiati (CT)
Tel. 095 213911 - Fax 095 213911
Cell. 337 888806
ardizzone@videobank.it

Nello Fabrizio SCIMONE

Cell. 340 8911730
nf.scimone@gmail.com

SARDEGNA

Marco SECCI
Via Torricelli, 9 - 09047 Selargius (CA)
Tel. 070 3320991 - Fax 1782746902
Cell. 348 6027354
agenzia.mgr@gmail.com

Marine Division

Alessio PAOLESCHI

SALES MANAGER MARINE DIVISION
Cell. +39 335 5251961
alessio.paoleschi@racmet.com



TECHNICAL & SALES CONSULTANT

Matteo AVANZI

Tel. 0376 96001 - Fax 0376 96422
Cell. 342 8068177
tecnico@racmet.com



Raccorderie Metalliche S.p.a. 
Struttura commerciale Estero Sales Organization



RM Sales Team

**Germany - Austria
Switzerland - Luxembourg**

Francesco GUANZINI
Tel. +39 0376 960285
Mob. +39 335 7371662
francesco.guanzini@racmet.com

Greece

Massimiliano GABBI
Tel. +39 0376 96 02 06
Mob. +39 335 7663876
massimiliano.gabbi@racmet.com

**Denmark - Finland - Norway
Sweden - Estonia - Latvia
Lithuania - Iceland
Great Britain - Ireland - Spain
Portugal - Netherlands**

Paolo IMPERIALE
Tel. +39 0376 960259
Mob. +39 344 0958857
paolo.imperiale@racmet.com

**France - Poland - Russia
Ukraine - Belarus
Czech Republic
Slovak Republic
Hungary - Belgium**

Roberto PEREZ
Tel. +39 0376 960122
Mob. +39 344 0961187
roberto.perez@racmet.com

**RACCORDERIE METALLICHE
FRANCE**

Frédéric DEVAUX
Tel. +33 4 78 67 54 46
Mob. +33 698565339
frederic.devaux@racmet.com

OTHER COUNTRIES

Tel. +39 0376 96001
ordini.info@racmet.com

Sales Partners

DEUTSCHLAND

Horst HAGEBOEKE
Linden Str., 41
D-32312 Lübbecke
Tel. +49 (0) 5741 370180
Fax +49 (0) 5741 370182
Mob. +49 (0) 170 204 2100
industrie@hageboeke.com

HUNGARY

György KOVÁCS
Mob. +36 20 432 4732
gyorgy.kovacs@racmet.com

**ROMANIA - BULGARIA
SLOVENIA - CROATIA
MACEDONIA - ALBANIA
MONTENEGRO
BOSNIA ERZEGOVINA
SERBIA-MOLDOVA
KOSOVO**

Dejan UGRINIC
Hrvatska - 10431 Sveta
Nedjelja
Novaki, Rakitska 25
Mob. +385 (0) 98 282 405
ugrineks@ugrineks.hr

**CZECH & SLOVAKIA
REPUBLIC**

Samuele PEDRIALI
Mob. +420 736 540 017
samuele.p@atlas.cz

**Technický poradce
Radim OBERHERR**
Mob. +420 777 049 805

GREECE

**B. Giannopoulos
& SIA O.E.**
Varis-Koropiou 40-42, Ave
16672 Vari-Athens
Tel. +30 210 9654006
Fax +30 210 9654666
info@bgiannopoulos.gr

POLAND

Robert WRÓBLEWSKI
Tel. +48 603 093 881
robert.wroblewskirm@gmail.com

RUSSIA

Andrej SINELNIKOV
Tel. +7 9219405036
andrej.sinelnikov@racmet.com

Marine Division

**MARINE DIVISION
Alessio PAOLESCHI**
SALES MANAGER MARINE DIVISION
Cell. +39 335 5251961
alessio.paoleschi@racmet.com



RM Pressfitting GmbH

Wagmüllerstraße 23
Tel. +49 (0)89 242 90 90 0
Fax +49 (0)89 242 90 90 33
info@kaiser-zenneck.de



Technische Beratung Für Pressfittingsysteme

DEUTSCHLAND

Roger PFATTHEICHER
Mob. +49 (0)151 52483379
r.pfattheicher@racmet.com

DEUTSCHLAND

Stephan SCHAPER
Mob. +49 (0)170 7216127
s.schaper@racmet.com

DEUTSCHLAND

Mike ROCKMANN
Mob. +49 (0)151 24069608
m.rockmann@racmet.com

DEUTSCHLAND

Max FRIEßL
Mob. +49 (0)151 12947989
m.friessl@racmet.com

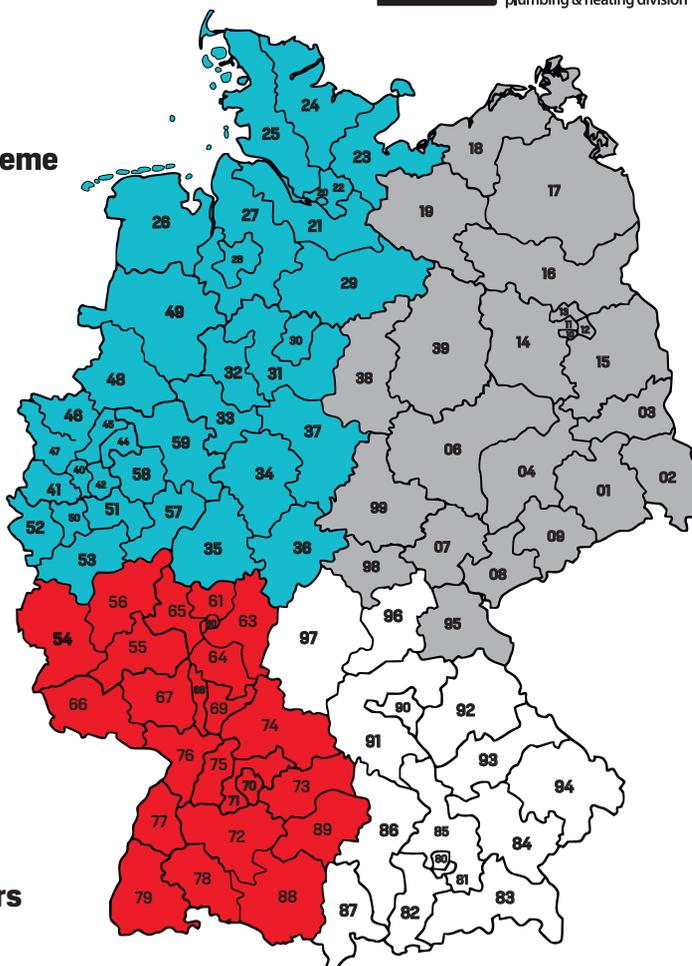

RM Sales Team

**Germany - Austria
Switzerland - Luxembourg**

Francesco GUANZINI
Tel. +39 0376 960285
Mob. +39 335 7371662
francesco.guanzini@racmet.com

Sales Partners

DEUTSCHLAND

Horst HAGEBOEKE
Linden Str., 41
D-32312 Lübbecke
Tel. +49 (0) 5741 370180
Fax +49 (0) 5741 370182
Mob. +49 (0) 170 204 2100
industrie@hageboeke.com

Raccorderie Metalliche France

1 rue des Piverts
69800 SAINT-PRIEST
Tel. +33 4 78 67 54 46
Mob. +33 698565339
frederic.devaux@racmet.com

RM Sales Team

Roberto PEREZ
Tel. +39 0376 960122
Mob. +39 344 0961187
roberto.perez@racmet.com

Frédéric DEVAUX
Responsable des ventes France
Tel. +33 4 78 67 54 46
Mob. +33 698565339
frederic.devaux@racmet.com

Marine Division

MARINE DIVISION
Alessio PAOLESCHI
SALES MANAGER MARINE DIVISION
Cell. +39 335 5251961
alessio.paoleschi@racmet.com



Condizioni Generali di Vendita

Di seguito sono riportate le Condizioni Generali di Vendita ("CGV") applicabili a tutti i rapporti di vendita tra Raccorderie Metalliche S.p.A. ("RM" o la "Società") e i soggetti che effettuano, direttamente o tramite agente, un ordine di merce (gli "Acquirenti" o, singolarmente, l'Acquirente").

Tutte le CGV, incluse le presenti premesse, si intendono pertanto conosciute ed accettate dagli Acquirenti, senza riserva alcuna, con il conferimento dell'ordine a RM, a nulla rilevando eventuali condizioni generali predisposte dall'Acquirente.

Le CGV trovano applicazione ai rapporti di vendita, in quanto non derogate da specifici accordi contrattuali tra RM e gli Acquirenti.

Nell'interpretazione ed esecuzione degli ordini si farà riferimento inoltre alle clausole previste dagli Incoterms edizione 2020.

1. Ordini

- 1.1 Le nostre offerte sono da considerarsi impegnative solo a fronte di una regolare conferma d'ordine scritta ("CdO") inviata all'Acquirente da RM.
- 1.2 Gli ordini richiesti a RM non sono vincolanti fino a CdO scritta.
- 1.3 E' facoltà di RM di richiedere ulteriori chiarimenti prima di accettare l'ordine ovvero di rifiutarlo a proprio insindacabile giudizio.
- 1.4 Gli ordinativi di merce si intendono fatti con riferimento al catalogo vigente. I prodotti ed i prezzi riportati sono da considerarsi comunque indicativi. E' facoltà di RM di modificare le caratteristiche tecniche dei prodotti indicati e di rivedere i prezzi.

2. Prezzo

- 2.1 Il prezzo, le modalità e i termini di pagamento sono quelli indicati nella CdO o in fattura e sono vincolanti per l'Acquirente.
- 2.2 In nessun caso l'Acquirente potrà ritardare, ridurre o sospendere il pagamento. In caso di mancato o parziale pagamento, l'Acquirente sarà considerato in mora senza necessità di formale diffida e saranno applicabili gli interessi legali di mora ai sensi degli articoli 2 lettera e), 4 e 5 del D.Lgs. 9 Ottobre 2002 n. 231.
- 2.3 È sempre salva la facoltà per RM di sospendere l'esecuzione di ordini, qualora l'Acquirente non abbia regolarmente adempiuto ai pagamenti relativi a precedenti ordinativi ovvero abbia dimostrato di non essere in grado di adempiere al proprio pagamento. In tale caso, l'ordine potrà essere eseguito soltanto a fronte di un pagamento anticipato ovvero a seguito di presentazione di idonea garanzia di gradimento di RM.
- 2.4 Nel caso di aumenti del prezzo della merce in corso d'opera superiori al 5% del prezzo indicato in catalogo, tali diversi importi saranno comunicati da RM all'Acquirente. Tali diversi importi sono vincolanti per l'Acquirente, fatto salvo, in questo caso, il suo diritto di rinunciare all'acquisto della merce, senza che l'Acquirente possa avanzare pretese di danni nei confronti di RM.

3. Trasporto

- 3.1 Salvo diversamente previsto nel Contratto di Vendita, i prodotti saranno consegnati al cliente in conformità alla Regola Incoterms 2020, Ex-Works (EXW) o FCA – stabilimento del Venditore.

4. Consegna

- 4.1 I termini di consegna sono da intendersi indicativi e non sono vincolanti per la Società e l'eventuale ritardo non potrà in alcun modo dare diritto all'Acquirente di recedere dal contratto, annullare l'ordine, sospendere, ridurre o ritardare il pagamento del prezzo, o pretendere il pagamento di danni, di qualunque natura, anche in forma di interessi moratori.
- 4.2 In ogni caso, i termini di consegna decorrono esclusivamente dalla data della CdO. Sono inefficaci eventuali termini riportati nell'ordine.
- 4.3 Qualora l'Acquirente necessitasse di specifici termini di consegna, questi dovranno preventivamente essere concordati e per essere efficaci dovranno inoltre essere confermati per iscritto nella CdO. In ogni caso, è fatto salvo il caso della forza maggiore, con ciò intendendosi, a titolo puramente esplicativo ma non esaustivo, casi di scioperi anche dei vettori, guerre, epidemie, catastrofi, atti terroristici, incidenti, chiusura delle frontiere o impedimento per ordine dell'Autorità.
- 4.4 Nel caso in cui la consegna diventi impossibile o particolarmente gravosa, RM si riserva il diritto di annullare l'ordine senza che l'Acquirente possa avanzare richiesta di danni.

5. Riserva di Proprietà

- 5.1 RM si riserva il diritto di proprietà sulla merce sino a quando saranno interamente pagati tutti gli importi relativi al prezzo della merce ed al trasporto, ivi incluse a titolo esemplificativo ma non esaustivo le spese di imballaggio e di dogana, quest'ultime se applicabili.
- 5.2 In caso di risoluzione del contratto per inadempimento dell'Acquirente, gli acconti pagati resteranno acquisiti a RM a titolo d'indennità.

6. Reclami

- 6.1 Eventuali reclami per difetti della merce dovranno essere comunicati entro dieci giorni dal ricevimento della stessa.
- 6.2 Gli eventuali reclami non danno diritto all'Acquirente di sospendere o ritardare il pagamento nei termini indicati.
- 6.3 Nel caso in cui l'Acquirente richieda la compatibilità della merce per un uso particolare, tale richiesta dovrà avvenire con l'ordine e avrà valore solo se confermata specificatamente per iscritto nella CdO.

7. Garanzia sistemi a pressare

- 7.1 Per quanto concerne la garanzia dei sistemi a pressare, fanno fede le condizioni ed i termini esposti sul Manuale Tecnico Sistemi a Pressare di Raccorderie Metalliche S.p.A.

8. Lingua, Controversie, Legge applicabile

- 8.1 Eventuali altre traduzioni delle CGV sono da intendersi di mera cortesia e non superano quella italiana, la quale è la sola che fa fede.
- 8.2 In caso di controversie è competente in via esclusiva il Tribunale del luogo dove ha sede la Società.
- 8.3 Per quanto non previsto dalle presenti CGV, i rapporti di vendita tra RM e gli Acquirenti saranno regolati dalla legge italiana.

General Conditions of Sale

Below you can find our General Conditions of Sale (hereinafter, the “GCS”) that shall apply to all sale relationships between Raccorderie Metalliche S.p.A. (hereinafter, “RM” or the “Company”) and subjects who place their orders, either directly or through their agents, with the latter (hereinafter, the “Purchasers” or, individually, the “Purchaser”).

All GCS (including the recitals) are therefore acknowledged and accepted by the Purchasers, without reservation, on the date of the order placement to RM; in case of existing Purchaser’s conditions, the GCS will prevail.

The GCS shall apply to all sale relationships, unless otherwise agreed upon between RM and the Purchasers.

To interpret and execute the orders, the parties shall moreover refer to the provisions provided for by Incoterms 2020.

1. Orders

- 1.1 Our offers shall be considered as binding only in case of regular order confirmation in written form (hereinafter, the “OC”) sent by RM to the Purchaser.
- 1.2 The orders sent to RM shall be considered to be binding only in case a written OC is sent to the Purchaser.
- 1.3 RM is entitled to require further information before accepting an order, as well as to decline the latter, at its sole discretion.
- 1.4 The orders shall refer to RM’s catalogue being in force from time to time. Anyway, both the products and the prices are indicative. RM reserves the right to modify the technical features of the products and readjust the prices.

2. Price

- 2.1 Price, payment method and conditions being indicated in the OC are binding on the Purchaser.
- 2.2 Under no circumstances, the Purchaser may delay, reduce or cease payments. In case of partial or total non payment, the Purchaser will be considered to be in arrears, with no need to send him formal injunction, and in this case interest of arrears will be applied according to articles 2 letter e), 4 and 5 of the Decree Law N° 231, dated 9th October 2002.
- 2.3 RM reserves the right to stop the execution of orders, in the event the Purchaser has not fulfilled payment relating to preceding orders, i.e. has proven not to be in a position to fulfil its payment. In such a case, the orders will only be executed against a payment in advance and after RM sends its consent to the Purchaser.
- 2.4 In case of price increase regarding goods belonging to orders in progress and exceeding 5 % of the price contained in the catalogue, RM will inform the Purchaser about the relevant different amounts. The latter will be binding on the Purchaser, who has anyway the right to refuse to purchase the goods but not the right to put forward claims against RM.

3. Transport

- 3.1 Unless otherwise provided in the Sales Contract, the products will be delivered to the customer according to the Incoterms 2020, Ex-Works (EXW) or FCA – Supplier’s company.

4. Delivery

- 4.1 The delivery time is indicative and not binding on the Company and a possible delay does not entitle the Purchaser to back out of a contract, cancel an order, cease, reduce, delay a payment of the price, nor claim for any damages and/or interest of arrears.
- 4.2 In any case, the delivery time starts on the date of the OC. Possible different terms contained in the orders will be considered null and void.
- 4.3 In case the Purchaser requires a specific delivery time, the latter shall preliminarily be agreed and written in the OC to confirm its validity. In any case, the foregoing is without prejudice to force majeure including, but not limited to strike (even forwarders’ strike), war, epidemics, disasters, terrorist attacks, accidents, closed borders, authority vetoes.
- 4.4 In the event it is impossible or very difficult to deliver, RM reserves the right to cancel the order and the Purchaser is not entitled to put forward claims against RM.

5. Retention of Title

- 5.1 RM reserves its property right concerning the goods, until all amounts relating to the price of the goods and the freight including, but not limited to packing & customs charges (if applicable).
- 5.2 In case of contract termination due to the Purchaser’s breach, possible down payments shall remain acquired by RM as indemnity.

6. Complaints

- 6.1 Possible complaints regarding defects of the goods shall be notified within ten days from the receiving of the latter by the Purchaser.
- 6.2 Possible complaints do not entitle the Purchaser to stop or delay the payment of the goods, which has to be issued within the scheduled time.
- 6.3 In case the Purchaser requires the goods to be conformed to a special purpose, the relevant request shall be made with the order and it shall be valid only in case it has been specifically confirmed in writing in the OC.

7. Warranty of press systems.

- 7.1 Concerning the warranty of press systems, the terms and conditions indicated in Press Systems Technical Manual of Raccorderie Metalliche S.p.A. shall apply.

8. Language, Disputes, Applicable Law

- 8.1 Any possible translation other than the present GCS one shall be intended as mere favour and shall not prevail over the Italian text, which is the only applicable text.
- 8.2 All possible disputes shall be subject to the exclusive jurisdiction of the court of the place in which the Company has its registered office.
- 8.3 For any aspect not provided for by the present GCS, the sales relationships between RM and the Purchasers shall be ruled by the Italian law.

Allgemeine Geschäftsbedingungen

Nachfolgend werden die Allgemeinen Geschäftsbedingungen aufgeführt, die auf alle Verkaufsbeziehungen zwischen Raccorderie Metalliche S.p.A. ("RM" oder die "Gesellschaft") und Personen, die direkt oder durch einen Vertreter eine Bestellung aufgeben (im Folgenden "Käufer") anwendbar sind. Sämtliche AGB, einschließlich der vorliegenden Vorbemerkungen, verstehen sich vorbehaltlos als von den Käufern verstanden und akzeptiert durch die Bestellerteilung an RM, wobei etwaige verfasste allgemeine Geschäftsbedingungen des Käufers keine Bedeutung haben. Die AGB finden Anwendung in den Verkaufsbeziehungen, weil sie nicht von bestimmten Vertragsvereinbarungen zwischen RM und den Käufern abweichen. In der Beurteilung und Ausführung der Bestellungen wird außerdem auf die von Incoterms Ausgabe 2020 vorgesehenen Klauseln Bezug genommen.

1. Bestellungen

- 1.1 Unsere Bestellungen sind als bindend zu betrachten nur bei Vorliegen einer regulären schriftlichen Auftragsbestätigung ("AB"), die dem Käufer durch RM zugestellt wird.
- 1.2 Die an RM angefragten Bestellungen sind bis zur schriftlichen AB nicht bindend.
- 1.3. RM steht es frei, vor der Bestellannahme weitere Auskünfte einzuholen oder die Bestellung nach eigenem Ermessen abzulehnen.
- 1.4 Die Warenbestellungen verstehen sich in Bezug auf den gültigen Katalog. Die angegebenen Produkte und Preise sind als maßgebend zu verstehen. RM behält sich das Recht vor, Änderungen an den technischen Eigenschaften der Produkte vorzunehmen und die Preise anzupassen.

2. Preis

- 2.1 Preis, Zahlungsbedingungen und Zahlungsfristen sind in der Auftragsbestätigung angegeben und sind bindend für den Käufer.
- 2.2. In keinem Fall darf der Käufer die Zahlung verzögern, mindern oder aufheben. Bei Nichtzahlung oder teilweiser Zahlung befindet sich der Käufer in Verzug, ohne dass es einer formellen Benachrichtigung bedarf, und es werden Verzugszinsen gemäß des italienischen Gesetzesdekrets Nr. 231, Art. 2 Satz 4 und 5 vom 9. Oktober 2002 angerechnet. Weiterhin behält sich RM das Recht vor, die Ausführung von Bestellungen aufzuheben, wenn der Käufer nicht ordnungsgemäß Zahlungen für vorherige Bestellungen vorgenommen hat oder anderweitig bewiesen hat, zahlungsunfähig zu sein. In diesem Fall kann die Bestellung nur bei vorzeitiger Zahlung oder bei Vorliegen entsprechender Vertrauensgarantie durch RM ausgeführt werden.
- 2.4 Im Falle von Preiserhöhung über 5% im Vergleich zum Katalogpreis bei Waren in Bearbeitung, wird RM die entsprechenden Beträge dem Käufer mitteilen. Diese abweichenden Beträge sind für den Käufer bindend, unberührt seines Rechts, in diesem Fall auf den Kauf der Ware zu verzichten, ohne dass der Käufer Schadensersatz gegenüber RM fordern kann.

3. Transport

- 3.1 Sofern im Kaufvertrag nichts anderes vereinbart wurde, werden die Produkte gemäß den Incoterms 2020, Ex-Works (EXW) oder FCA - Werk des Verkäufers an den Kunden geliefert.

4. Lieferung

- 4.1 Die Lieferzeiten sind nicht verbindlich und nicht bindend für die Gesellschaft. Eine eventuelle Verspätung berechtigt den Käufer in keiner Weise vom Vertrag zurück zu treten, die Bestellung zu annullieren, die Zahlung einzustellen, zu mindern oder zu verzögern, oder Schadensersatz jeglicher Art zu fordern, einschließlich der Verzugszinsen.
- 4.2 In jedem Fall richten sich die Lieferzeiten ausschließlich nach dem Datum der AB. Eventuelle in der Bestellung angegebene Fristen sind unwirksam.
- 4.3. Falls der Käufer bestimmte Lieferzeiten benötigt, müssen diese im Voraus vereinbart werden und für ihre Wirksamkeit müssen sie außerdem schriftlich in der AB bestätigt werden. Jedenfalls bleiben die Fälle höherer Gewalt unberührt, darunter, als Erläuterung aber keinesfalls vollständig, Fälle von Streik, einschließlich der Beförderungsunternehmen, Kriege, Epidemien, Katastrophen, Terroranschläge, Grenzschießungen oder Verhinderung durch behördliche Anweisung.
- 4.4. für den Fall, dass die Lieferung unmöglich oder besonders belastend wird, behält sich RM das Recht vor, die Bestellung zu annullieren, ohne dass der Käufer Schadensersatz fordern kann.

5. Eigentumsvorbehalt

- 5.1 RM behält sich das Recht des Eigentums an der Ware bis zur vollständigen Zahlung aller Beträge bezüglich des Warenpreises und des Transports vor, einschließlich - als Erläuterung aber keinesfalls vollständig - Verpackungs- und Zollkosten, falls anwendbar.
- 5.2 Im Falle der Vertragsauflösung wegen Nichterfüllung durch den Käufer werden bereits geleistete Anzahlungen an RM als Entschädigung erworben gelten.

6. Beanstandungen

- 6.1 Eventuelle Beanstandungen wegen fehlerhafter Ware müssen innerhalb einer Frist von zehn Tagen ab Warenerhalt mitgeteilt werden.
- 6.2 Eventuelle Beanstandungen berechtigen nicht den Käufer, die Zahlung innerhalb der genannten Frist einzustellen oder zu verzögern.
- 6.3 Falls der Käufer die Kompatibilität der Ware für eine bestimmte Verwendung verlangt, muss dies Anfrage mit der Bestellung erfolgen und sie wird nur durch schriftliche Bestätigung in der AB wirksam.

7. Gewährleistung Drucksysteme.

- 7.1 Bezüglich der Gewährleistung der Drucksysteme, sind die im Technischen Handbuch Drucksysteme von Metalliche S.p.A. angegebenen Bedingungen und Fristen verbindlich.

8. Sprache, Streitigkeiten, anwendbares Recht

- 8.1 Eventuelle Übersetzungen der AGB sind als reine Dienstleistung zu sehen und stehen nicht über die italienische Version, die ausschließlich gültig ist.
- 8.2 Bei Streitigkeiten ist ausschließlich das Gericht zuständig, in dessen Bezirk die Gesellschaft ihren Sitz hat.
- 8.3 Falls nicht durch die vorliegenden AGB abgedeckt, werden die Kaufbeziehungen zwischen RM und Käufer durch italienisches Recht geregelt.

Conditions Générales de Vente

Ci-Àprès les Conditions Générales de Vente ("CGV") applicables à tous les rapports de vente entre Raccorderie Metalliche S.p.A. ("RM" ou la "Société") et les sujets qui effectuent, directement ou par l'intermédiaire d'un agent, un ordre de marchandise (les "Acheteurs" ou, individuellement, l'"Acheteur"). Toutes les CGV, y compris ces prémisses, s'entendent par conséquent, connues et acceptées par les Acheteurs, sans aucune réserve, avec l'attribution de l'ordre à RM, si les éventuelles conditions de vente prédisposées par l'Acheteur ne sont pas en contradiction. Les CGV s'appliquent aux rapports de vente dans la mesure où elles ne dérogent pas d'accords contractuels spécifiques entre RM et les Acheteurs. Pour l'interprétation et l'exécution des commandes, il faudra en outre faire référence aux clauses prévues par les conditions internationales de vente Incoterms édition 2020.

1. Commandes

- 1.1 Nos offres doivent être considérées liantes uniquement vis-à-vis d'une confirmation régulière d'une commande écrite ("CdC") envoyée à l'Acheteur par RM.
- 1.2 Les commandes requises à RM ne sont liantes qu'après la rédaction de la CdC.
- 1.3 RM est en droit de demander des précisions supplémentaires avant d'accepter la commande ou de la refuser à son jugement sans appel.
- 1.4 Les commandes de marchandise s'entendent comme passées sur la base du catalogue en vigueur. Les produits et les prix indiqués doivent dans tous les cas être considérés comme indicatifs. RM est en droit de modifier les caractéristiques techniques des produits indiqués et de revoir les prix.

2. Prix

- 2.1 Le prix, les modalités et les délais de paiement sont ceux indiqués dans la CdC ou dans la facture et sont liants pour l'Acheteur.
- 2.2 En aucun cas l'Acheteur ne pourra retarder, réduire ou suspendre le paiement. En cas de non-paiement ou de paiement partiel, l'Acheteur sera considéré en demeure sans obligation d'une mise en demeure formelle et des intérêts légaux pour retard de paiement s'appliqueront, conformément aux articles 2 point e), 4 et 5 du décret législatif du 9 octobre 2002 n° 231.
- 2.3 RM a toujours le droit de suspendre l'exécution de la commande dans le cas où l'acheteur n'a pas effectué les paiements relatifs aux commandes précédentes ou s'il a démontré être incapable d'effectuer le paiement. Dans ce cas, la commande pourra être effectuée uniquement contre un paiement anticipé après la présentation d'une garantie de complaisance de RM.
- 2.4 En cas d'augmentations du prix de la marchandise en cours de production supérieures à 5 % du prix indiqué dans le catalogue, ces montants différents seront communiqués à l'Acheteur par RM. Ces différents montants liants pour l'Acheteur, sous réserve, dans ce cas d'exercer son droit de renoncer à l'achat de la marchandise sans que l'Acheteur puisse prétendre des dommages et intérêts vis à vis de RM.

3. Transport

- 3.1 Sauf disposition contraire dans le contrat de vente, les produits seront livrés au client conformément à la réglementation Incoterms 2020, Ex-Works (EXW) ou FCA – à l'adresse du vendeur.

4. Livraison

- 4.1 Les délais de livraison sont indicatifs et non contraignants pour la Société et tout retard éventuel ne peut en aucune façon permettre à l'acheteur de résilier le contrat, annuler la commande, suspendre, réduire ou retarder le paiement du montant, ou exiger le paiement de dommages de toute nature, de quelque nature que ce soit, même sous la forme d'intérêts moratoires.
- 4.2 Dans tous les cas, les délais de livraison commencent à courir exclusivement à la date de la CdC. Les éventuels délais reportés dans la commande ne sont pas pris en compte.
- 4.3 Dans le cas où l'Acheteur aurait besoin de délais de livraison spécifiques, ceux-ci devront préalablement être fixés et pour qu'ils deviennent effectifs, ils devront être confirmés par écrit dans la CdC. Dans tous les cas, exception est faite en cas de force majeure, c'est à dire à titre purement explicatif, mais sans s'y limiter, les cas de grève, également des transporteurs, les guerres, les épidémies, les catastrophes, les actes de terrorisme, les accidents, la fermeture des frontières ou tout empêchement sur l'ordre des Autorités.
- 4.4 Dans le cas où la livraison devient impossible ou particulièrement excessive, RM se réserve le droit d'annuler la commande sans que l'Acheteur puisse réclamer des dommages et intérêts.

5. Réserve de propriété

- 5.1 RM se réserve le droit de propriété sur la marchandise jusqu'à ce que soient payés tous les montants relatifs au prix de la marchandise et au transport, y compris, à titre d'exemple mais sans s'y limiter, les frais de conditionnement et de douane, si ces derniers sont applicables.
- 5.2 En cas de résiliation du contrat par non-exécution de l'Acheteur, les acomptes payés resteront acquis à RM à titre d'indemnisation.

6. Réclamations

- 6.1 Les éventuelles réclamations pour défauts de la marchandise devront être communiquées dans les dix jours à compter de la réception de celle-ci.
- 6.2 Les éventuelles réclamations n'autorisent pas l'Acheteur à suspendre ou retarder le paiement dans les délais indiqués.
- 6.3 Dans le cas où l'Acheteur requiert la compatibilité de la marchandise pour un usage particulier, cette demande devra parvenir avec la commande et sera effective uniquement si spécifiquement confirmée par écrit dans la CdC.

7. Garantie systèmes à sertir

- 7.1 En ce qui concerne la garantie des systèmes à sertir, font foi les termes et les conditions exposés dans le Manuel Technique des Systèmes à Presser de Raccorderie Metalliche S.p.A.

8. Langue, Litige, Juridiction

- 8.1 Les éventuelles traductions des CGV ne sont fournies que pour des raisons de commodité mais l'Italien est la seule langue faisant foi.
- 8.2 En cas de litige, seul le Tribunal du lieu où la Société à son siège, est compétent.
- 8.3 Pour tout ce qui n'est pas prévu par les présentes CGV, les rapports de vente entre RM et les Acheteurs seront régis par la loi italienne.

Condiciones Generales de Venta

A continuación encontrará las Condiciones Generales de Venta ("CGV") que se aplican a todas las ventas entre Raccorderie Metalliche S.p.A. (en adelante "RM" o la "Sociedad") y los sujetos que efectúan, directa o indirectamente a través de un agente, un pedido de productos (los "Compradores" o, de manera individual, el "Comprador"). Todas las CGV, incluso esta introducción, se entienden por lo tanto conocidas y aceptadas por los Compradores, sin reserva alguna, al otorgar a RM el pedido, y prevalecen ante posibles condiciones generales redactadas por el Comprador. Las CGV se aplican a las relaciones de venta, siempre que no hayan sido derogadas por acuerdos contractuales específicos entre RM y los Compradores. Para interpretar y ejecutar los pedidos se tomarán además como referencia las cláusulas previstas por los Incoterms edición de 2020.

1. Pedidos

- 1.1 Nuestras ofertas se considerarán vinculantes únicamente en el caso de confirmación escrita del pedido ("CdP") enviada por RM al Comprador.
- 1.2 Los pedidos efectuados a RM no son vinculantes si no existe la confirmación del pedido ("CdP") escrita.
- 1.3 RM tiene la facultad para solicitar ulteriores aclaraciones antes de aceptar el pedido o incluso para rechazarlo, en cuyo caso, su decisión es inapelable.
- 1.4 Los pedidos de mercancía se entienden efectuados según el catálogo vigente. Los productos y los precios que allí aparecen deben considerarse indicativos. RM tiene la facultad de modificar las características técnicas de los productos indicados y de rectificar los precios.

2. Precio

- 2.1 El precio, las formas y los plazos de pago son los que se indican en la CdP o en la factura y son vinculantes para el Comprador.
- 2.2 En ningún caso el Comprador podrá retrasar, reducir o suspender el pago. En caso de pago parcial o pago no efectuado, el Comprador será considerado moroso sin necesidad de intimación formal y se le aplicarán los intereses por mora de conformidad con los artículos 2 letra e), 4 y 5 del Decreto Legislativo del 9 de octubre de 2002 n. 231.
- 2.3 RM se reserva siempre la facultad de suspender la ejecución de los pedidos, en caso de que el Comprador no haya cumplido con los pagos de pedidos anteriores o haya demostrado que no puede realizar los mismos. En este caso, se podrá dar curso al pedido solo si se efectúa el pago anticipado o se presenta una garantía adecuada que cuente con el beneplácito de RM.
- 2.4 Si durante el proceso de venta, se produjeran aumentos de precio de la mercancía superiores al 5% del precio indicado en el catálogo, los nuevos importes serán comunicados por RM al Comprador. Dichos importes serán vinculantes para el Comprador, sin perjuicio, en este caso, de su derecho a renunciar a la compra de la mercancía, sin que por este motivo pueda exigir ninguna indemnización por parte de RM.

3. Transporte

- 3.1 A menos que se estipule lo contrario en el Contrato de venta, los productos se entregarán al cliente de acuerdo con los Incoterms 2020, Ex-Works (EXW) o FCA - establecimiento del vendedor.

4. Entrega

- 4.1 Los plazos de entrega son indicativos y no son vinculantes para la Sociedad y en ningún caso el eventual retraso podrá dar derecho al Comprador para rescindir el contrato, anular el pedido, suspender, reducir o retrasar el pago del precio, así como tampoco pretender una indemnización por daños de cualquier tipo, incluso bajo forma de intereses moratorios.
- 4.2 De cualquier forma, los plazos de entrega se cuentan exclusivamente a partir de la fecha de la CdP. No tendrán validez los plazos indicados en el pedido.
- 4.3 En caso de que el Comprador necesitara determinados plazos de entrega, los mismos tendrán que pactarse previamente y para que tengan validez deberán ser confirmados por escrito en la CdP, sin perjuicio de los casos de fuerza mayor, bajo cuyo nombre se entienden, a modo de ejemplo no exhaustivo, huelgas incluso de los transportistas, guerras, epidemias, catástrofes, actos terroristas, accidentes, cierre de fronteras o impedimento por orden de las autoridades.
- 4.4 En caso de que la entrega sea imposible o muy difícil y costosa, RM se reserva el derecho de anular el pedido sin que el Comprador pueda exigir ningún tipo de indemnización por daños y perjuicios.

5. Reserva de Propiedad

- 5.1 RM se reserva el derecho de propiedad de la mercancía hasta cuando no hayan sido pagados totalmente todos los importes correspondientes al precio de la misma y al transporte, incluso a modo de ejemplo no exhaustivo los gastos de embalaje y de aduana, estos últimos siempre que correspondan.
- 5.2 En caso de rescisión del contrato por incumplimiento del Comprador, los pagos a cuenta que haya percibido RM serán retenidos por RM a título de indemnización.

6. Reclamaciones

- 6.1 Las eventuales reclamaciones por defectos de la mercancía tendrán que ser comunicadas dentro de un plazo de diez días a partir de la fecha de recepción de la misma.
- 6.2 Las eventuales reclamaciones no dan derecho al Comprador para que suspenda o retrase el pago dentro de los plazos estipulados.
- 6.3 En el caso de que el Comprador requiera la compatibilidad de la mercancía para un uso especial, dicha solicitud se deberá hacer en el pedido y tendrá valor sólo si se confirma por escrito y explícitamente en la CdP.

7. Garantía de sistemas de prensado.

- 7.1 Por lo que se refiere a la garantía de los sistemas de prensado, tienen validez las condiciones y los términos expuestos en el Manual Técnico de Sistemas de Prensado de Raccorderie Metalliche S.p.A.

8. Lengua, Litigios, Ley aplicable

- 8.1 Las posibles traducciones de las CDV deben entenderse como traducciones de cortesía, que no prevalecen ante el texto en italiano que es el único que da fe.
- 8.2 En caso de litigios es competente en vía exclusiva el Tribunal del lugar en el que tiene su sede la Sociedad.
- 8.3 Todos los aspectos no previstos en estas CGV y relacionados con las relaciones de venta entre RM y los Compradores estarán regulados por la ley italiana.

Indice analitico / Index

(Codice articolo/item code -> pagina/page)

114015200	30, 109	116015203	28	181015450G	76	181022901CG	79	181054451G	77	182139000	43
114018200	30, 109	116015300	28, 75, 97, 108	181015450HT	98	181022901CST	101	181054451HT	99	182168000	43
114022200	30, 109	116018030	29	181015451CG	110	181022901CG	113	181054451ST	111	183015000	47
114028200	30, 109	116018200	27, 75, 108	181015451C	36	181022901G	79	181054600	37	183015000G	84
114035200	30, 109	116018203	28	181015451C	36	181022901HT	101	181054601	37	183015000HT	103
114042200	30, 109	116018300	28, 75, 97, 108	181015451CG	77	181022901ST	113	181054900	38	183015000ST	115
114054200	30, 109	116022030	29	181015451CST	99	181028150	33	181054900G	78	183015001	47
114076200	30	116022200	27, 75, 108	181015451C	111	181028151	33	181054900HT	100	183015001G	84
114088200	30	116022203	28	181015451G	77	181028300	34	181054900ST	112	183015002	48
114108200	30	116022300	28, 75, 97, 108	181015451HT	99	181028301	34	181054901	39	183015002G	85
11501525N	203	116028030	29	181015451ST	111	181028450	35	181054901G	79	183015003	49
11501525R	204	116028200	27, 75, 108	181015600	37	181028450C	35	181054901HT	101	183015003G	85
11501525V	204	116028203	28	181015601	37	181028450CG	76	181054901ST	113	183015003HT	104
11501526G	203	116028300	28, 75, 97, 108	181015900	38	181028450CST	98	181076150C	33	183015003ST	116
11501825N	203	116035030	29	181015900C	38	181028450CG	110	181076151C	33	183015012	48
11501825R	204	116035200	27, 75, 108	181015900CG	78	181028450G	76	181076300	34	183015012G	85
11501825V	204	116035203	28	181015900CST	100	181028450HT	98	181076301	34	183015020GD	93
11501826G	203	116035300	28, 75, 97, 108	181015900CG	112	181028450ST	110	181076450	35	183015020G	93
11502230N	203	116042030	29	181015900C	78	181028451	36	181076450G	76	183015030GP	93
11502230R	204	116042200	27, 75, 108	181015900HT	100	181028451C	36	181076451	36	183015030HT	93
11502230V	204	116042203	28	181015900ST	112	181028451CG	77	181076451G	77	183018000	47
11502231G	203	116042300	28, 75, 97, 108	181015901	39	181028451CST	99	181076600	37	183018000G	84
11502830N	203	116054030	29	181015901C	39	181028451CG	111	181076601	37	183018000HT	103
11502830R	204	116054200	27, 75, 108	181015901CG	79	181028451G	77	181076900	38	183018000ST	115
11502830V	204	116054203	28	181015901CST	101	181028451HT	99	181076900G	78	183018001	47
11502831G	203	116054300	28, 75, 97, 108	181015901CG	113	181028451ST	111	181076901	39	183018001G	84
11503530N	203	116076007	201	181015901G	79	181028600	37	181076901G	79	183018002	48
11503530R	204	116076200	27, 75	181015901HT	101	181028601	37	181088150C	33	183018002G	85
11503530V	204	116076203	28	181015901ST	113	181028900	38	181088151C	33	183018003	49
11503532G	203	116076300	28, 75	181018150	33	181028900C	38	181088300	34	183018003G	85
11504240N	203	116088007	201	181018300	34	181028900CG	78	181088301	34	183018003HT	104
11504240R	204	116088200	27, 75	181018450	35	181028900CST	100	181088450	35	183018003ST	116
11504240V	204	116088203	28	181018450C	35	181028900CG	112	181088450G	76	183018012	48
11504241G	203	116088300	28, 75	181018450CG	76	181028900G	78	181088451	36	183018012G	85
11505440N	203	116108007	201	181018450CST	98	181028900HT	100	181088451G	77	183018012GD	93
11505440R	204	116108200	27, 75	181018450CG	110	181028900ST	112	181088600	37	183018030GD	93
11505440V	204	116108203	28	181018450G	76	181028901	39	181088601	37	183018030HT	93
11505441G	203	116108300	28, 75	181018450HT	98	181028901C	39	181088900	38	183018030G	84
11507670GM	203	116139200	27	181018450ST	110	181028901CG	79	181088900G	78	183018030HT	94
11507770NM	203	116139260	27	181018451	36	181028901CST	101	181088901	39	183018030G	93
11507770R	204	116168200	27	181018451C	36	181028901CST	113	181088901G	79	183018030HT	93
11507770VM	204	116168260	27	181018451CG	77	181028901G	79	18108150C	33	183022000	47
11508870GM	203	156015304	31	181018451CST	99	181028901HT	101	18108151C	33	183022000G	84
11509070NM	203	156054304	31	181018451CG	111	181028901ST	113	18108300	34	183022000HT	103
11509070R	204	156100304	31	181018451G	77	181035150	33	18108301	34	183022000ST	115
11509070VM	204	156100304G	31, 168	181018451HT	99	181035151	33	18108450	35	183022001	47
11510809GM	203	156102304	31	181018451ST	111	181035300	34	18108450G	76	183022001G	84
11510909NM	203	156102304G	31, 168	181018600	37	181035301	34	18108451	36	183022002	48
11510909VM	204	156108304	31	181018601	37	181035450	35	18108451G	77	183022002G	85
11510990R	204	156108316G	31, 168	181018900	38	181035450G	76	18108600	37	183022003	49
115139100N	203	15612304G	31, 168, 243	181018900C	38	181035450HT	98	18108601	37	183022003G	85
115139100V	204	156114304	31	181018900CG	78	181035450ST	110	18108900	38	183022003HT	104
115168100N	203	156114304G	31, 168, 243	181018900CST	100	181035451	36	18108900G	78	183022003ST	116
115168100V	204	156150304G	31, 168	181018900CG	112	181035451G	77	18108901	39	183022012	48
115183051F	206	156212304	31	181018900G	78	181035451HT	99	18108901G	79	183022012G	85
115183054E	205	156212304G	31, 168, 243	181018900HT	100	181035451ST	111	181139450	35	183022030GD	93
115183054F	206	156300304	31	181018900ST	112	181035600	37	181139451	36	183022030G	84
115183112F	206	156300304G	31, 168, 243	181018901	39	181035601	37	181139900	38	183022030HT	93
115183112H	205	156304304	31	181018901C	39	181035900	38	181139901	39	183022030HT	94
115183134E	205	156304304G	31, 168	181018901CG	79	181035900G	78	181168450	35	183022030HT	93
115183134F	206	156308304	31	181018901CST	101	181035900HT	100	181168451	36	183022030HT	93
115183154E	205	156308304G	31, 168	181018901G	113	181035900ST	112	181168900	38	183028000	47
115183200E	205	156312316G	243	181018901G	79	181035901	39	181168901	39	183028000G	84
115183200F	206	156500316	32	181018901HT	101	181035901G	79	182015000	43	183028000HT	103
115183200H	205	156500316G	32, 243	181018901ST	113	181035901HT	101	182015000G	81	183028000ST	115
115183242F	206	156600316	32	181022150	33	181035901ST	113	182015000HT	102	183028001	47
115183254F	206	156600316G	32, 243	181022151	33	181042150	33	182015000ST	114	183028001G	84
115183540E	205	171076035	67	181022300	34	181042151	33	182018000	43	183028002	48
115183540F	206	171088042	67	181022301	34	181042300	34	182018000G	81	183028002G	85
115683100E	205	171108054	67	181022450	35	181042301	34	182018000HT	102	183028003	49
115683100F	206	178015316	60, 118	181022450C	35	181042450	35	182018000ST	114	183028003G	85
115683100H	205	178018316	60, 118	181022450CG	76	181042450G	76	182022000	43	183028003HT	104
115683102F	206	178022316	60, 118	181022450CST	98	181042450HT	98	182022000G	81	183028003ST	116
115683102H	205	178028316	60, 118	181022450CG	110	181042450ST	110	182022000HT	102	183028012	48
115683112E	205	179015000	60	181022450G	76	181042451	36	182022000ST	114	183028012G	85
115683114E	205	179015001	66	181022450HT	98	181042451G	77	182028000	43	183028022	48
115683114F	206	179018000	60	181022450ST	110	181042451HT	99	182028000G	81	183028100GD	93
115683114H	205	179018001	66	181022451	36	181042451ST	111	182028000HT	102	1830287086GD	93
115683134E	205	179022000	60	181022451C	36	181042600	37	182028000ST	114	183035000	47
115683304E	205	179022001	66	181022451CG	77	181042601	37	182035000	43	183035000G	84
115683304F	206	179028000	60	181022451CST	99	181042900	38	182035000G	81	183035000HT	103
115683304H	205	179028001	66	181022451CG	111	181042900G	78	182035000HT	102	183035000ST	115
116000000	199	179035001	66	181022451G	77	181042900HT	100	182035000ST	114	183035001	47
116000003	199	179042001	66	181022451HT	99	181042900ST	112	182042000	43	183035001G	84
116000006	201	179054001	66	181022451ST	111	181042901	39	182042000G	81	183035002	48
116000011	199	179076001	66	181022600	37	181042901G	79	182042000HT	102	183035002G	85
116000012	199	179088001	66	181022601	37	181042901HT	101	182042000ST	114	183035003	49
116000016	201	179108001	66	181022900	38	181042901ST	113				

183042001	47	184028003I	58	187112035	53	189200139	44	191028022HT	105	192042035ST	115
183042001G	84	184028003IG	91	187112035G	87	189200168	44	191028022ST	117	192054018	45
183042002	48	184028342	57	187112042	53	189304018	44	191035015	59	192054022	45
183042002G	85	184028342G	90	187112042G	87	189304018G	82	191035015G	92	192054022G	83
183042003	49	184028343	57	187112042HT	104	189304022	44	191035018	59	192054028	45
183042003G	85	184028343G	90	187112042ST	116	189304022G	82	191035018G	92	192054028G	83
183042003HT	104	184035000	56	187112054	53	189304022HT	102	191035022	59	192054035	45
183042003ST	116	184035001	56	187112054G	87	189304022ST	114	191035022G	92	192054035G	83
183042012	48	184035002	57	18711242NPT	53	189304028	44	191035028	59	192054035HT	103
183042012G	85	184035002G	90	187114028	53	189304028G	82	191035028G	92	192054035ST	115
183042022	48	184035002I	58	187114028G	87	189304028HT	102	191035028HT	105	192054042	45
183042022G	85	184035002IG	91	187114035	53	189304028MF	43	191035028ST	117	192054042G	83
183042112G0	93	184035003	57	187114035G	87	189304028ST	114	191042015	59	192054042HT	103
183054000	47	184035003G	90	187114035HT	104	189304035	44	191042015G	92	192054042ST	115
183054000G	84	184035003I	58	187114035ST	116	189304035G	82	191042018	59	192076022	45
183054000HT	103	184035003IG	91	187114042	53	189304042	44	191042018G	92	192076028	45
183054000ST	115	184042000	56	187114042G	87	189304042G	82	191042022	59	192076035	45
183054001	47	184042001	56	18711435NPT	53	189304054	44	191042022G	92	192076042	45
183054001G	84	184042002	57	187139000R	52	189304054G	82	191042028	59	192076054	45
183054002	48	184042002G	90	187168000R	52	189304054HT	102	191042028EST	118	192076054G	83
183054002G	85	184042002I	58	187200054	53	189304076	44	191042028G	92	192088022	45
183054003	49	184042003	57	187200054G	87	189304076G	82	191042028HT	117	192088028	45
183054003G	85	184042003G	90	187200054HT	104	189304088	44	191042035	59	192088035	45
183054003HT	104	184042003I	58	187200054ST	116	189304088G	82	191042035G	92	192088042	45
183054003ST	116	184054000	56	18720054NPT	53	189304108	44	191042035HT	105	192088054	45
183054012	48	184054001	56	187212076	53	189304108G	82	191042035ST	117	192088054G	83
183054012G	85	184054002	57	187212076G	87	191000022	54	191054015	59	192088076	45
183054022	48	184054002G	90	187300088	53	191000022G	88	191054015G	92	192088076G	83
183054022G	85	184054002I	58	187300088G	87	191000028	54	191054018	59	192108022	45
183054200GD	93	184054003	57	187304015	53	191000028G	88	191054018G	92	192108028	45
183076000	47	184054003G	90	187304015G	87	191000028HT	105	191054022	59	192108035	45
183076000G	84	184054003I	58	187304018	53	191000028ST	117	191054022G	92	192108042	45
183076001	47	185000C0NG	92	187304018G	87	191000035	54	191054028	59	192108054	45
183076001G	84	185001122G	86	187304022	53	191000035G	88	191054028EST	118	192108076	45
183076003	49	185100128G	86	187304022G	87	19100028NPT	54	191054028G	92	192108076G	83
183076003G	85	185102015	49	187304022HT	104	191002015	54	191054035	59	192108088	45
183088000	47	185102015G	86	187304022ST	116	19102015G	88	191054035EST	118	192108088G	83
183088000G	84	185102015M	50	187304028	53	19102015HT	105	191054035G	92	192139035	46
183088001	47	185102018	49	187304028G	87	19102015ST	117	191054042	59	192139076	46
183088001G	84	185102018G	86	187304028HT	104	19102018	54	191054042G	92	192139088	46
183088003	49	185102018M	50	187304028ST	116	19102018G	88	191054042HT	105	192139108	46
183088003G	85	185102115	50	18730422NPT	53	19102018HT	105	191054042ST	117	192168035	46
183108000	47	185102115M	51	187308015	53	19102018ST	117	191076042	59	192168076	46
183108000G	84	185102118	50	187308015G	87	19102022	54	191076054	59	192168088	46
183108001	47	185102118M	51	187400108	53	19102022G	88	191076054G	92	192168108	46
183108001G	84	185102315	51	187400108G	87	19102028	54	191088054	59	192168139	46
183108003	49	185102318	51	188028022	46	19102028G	88	191088054G	92	193015000	62
183108003G	85	185102322	51	188028022G	81	19102028HT	105	191088076	59	193015000G	88
183139000	47	185304022	49	188035022	46	19102035	54	191088076G	92	193015000HT	106
183139003	49	185304022G	86	188035022G	81	19102035G	88	191108054	59	193015000ST	118
183168000	47	185304022M	50	188035028	46	19102042	54	191108076	59	193015002	62
183168003	49	185304122	50	188035028G	81	19102042G	88	191108076G	92	193015006	63
184015000	56	185304122M	51	188042028	46	19102042HT	105	191108088	59	193018000	62
184015001	56	185304218	50	188042028G	81	19102042ST	117	191108088G	92	193018000G	88
184015002	57	186042134R	42	188054028	46	19102054	54	191139076	59	193018000HT	106
184015002G	90	186054238R	42	188054028G	81	19102054G	88	191139088	59	193018000ST	118
184015002I	58	186100028	42	189100028	44	1910242NPT	54	191139108	59	193018002	62
184015002IG	91	186100035	42	189100035	44	191042028	54	191168076	59	193018006	63
184015003	57	186102015	42	189100035HT	102	191042028G	88	191168088	59	193022000	62
184015003G	90	186102018	42	189100035ST	114	191042028HT	105	191168108	59	193022000G	88
184015003I	58	186112042	42	189100042	44	191043035	88	191168139	59	193022000HT	106
184015003IG	91	186114035	42	189100042HT	102	191043035HT	105	192018015	45	193022000ST	118
184015012I	58	186114042	42	189100042ST	114	191043035ST	117	192018015G	83	193022002	62
184015013I	58	186200054	42	189100076	44	19104402	54	192018015HT	103	193022003	64
184018000	56	186304022	42	189100139	44	19104402G	88	192018015ST	115	193022004	64
184018001	56	187015000R	52	189100168	44	1910435NPT	54	192022015	45	193022006	63
184018002	57	187018000R	52	189102015	44	192000054	54	192022015G	83	193028000	62
184018002G	90	187022000R	52	189102015G	82	192000054G	88	192022018	45	193028000G	88
184018002I	58	187028000R	52	189102015HT	102	192000054HT	105	192022018G	83	193028000HT	106
184018002IG	91	187035000R	52	189102015ST	114	192000054ST	117	192022018HT	103	193028000ST	118
184018003	57	187042000R	52	189102015T	114	1920054NPT	54	192022018ST	115	193028002	62
184018003G	90	187054000R	52	189102018	44	1930304015	54	192028015	45	193028003	64
184018003I	58	18706000R	52	189102018G	82	1930304015G	88	192028015G	83	193028004	64
184018003IG	91	187088000R	52	189102018HT	102	1930304018	54	192028018	45	193028006	63
184018012I	58	187100022	53	189102018ST	114	1930304018G	88	192028018G	83	193035000	62
184018013I	58	187100022G	87	189102022	44	1930304022	54	192028022	45	193035000G	88
184022000	56	187100022HT	104	189102022G	82	1930304022G	88	192028022G	83	193035000HT	106
184022001	56	187100022ST	116	189102022HT	102	1930304022HT	105	192028022HT	103	193035000ST	118
184022002	57	187100028	53	189102022MF	43	1930304022ST	117	192028022ST	115	193035002	62
184022002G	90	187100028G	87	189102022ST	114	1930304028	54	192035015	45	193035003	64
184022002I	58	187100028HT	104	189102028	44	1930304028G	88	192035015G	83	193035004	64
184022002IG	91	187100028ST	116	189102028G	82	1930304028HT	105	192035018	45	193035006	63
184022003	57	187100035	53	189102028HT	102	1930304028ST	117	192035018G	83	193042000	62
184022003G	90	187100035G	87	189102028ST	114	19303422NPT	54	192035022	45	193042000G	88
184022003I	58	18710028NPT	53	189102035	44	191018015	59	192035022G	83	193042000HT	106
184022003IG	91	187102015	53	189102035G	82	191018015G	92	192035022HT	103	193042000ST	118
184022012I	58	187102015G	87	189102042	44	191018015HT	105	192035022ST	115	193042002	62
184022013I	58	187102015HT	104	189102042G	82	191018015ST	117	192035028	45	193042003	64
184022022I	58	187102015ST	116	189102054	44	191022015	59	192035028G	83	193042004	64
184022122	57	187102018	53	189102054G	82	191022015G	92	192035028HT	103	193042006	63
184022122G	90	187102018G	87	189102054HT	102	191022018	59	192035028ST	115	193054000	62

193076001	63	196000108N	196	198102028	41	316108000	122	383022022	132	390114035	135
193076002	62	196001009V	187	198102028G	80	316108003	121	383028000	131	390200054	135
193076003	64	196001012	188	198112042	41	316108005	120	383028001	131	390304015	135
193076004	64	196001013	188	198112042G	80	322060042	140	383028002	132	390304018	135
193076006	63	196001014	188	198114035	41	322060054	140	383028003	132	390304022	135
193088000	62	196001015	189	198114035G	80	322076054	140	383028012	132	390304028	135
193088000G	88	196001016	189	198200054	41	351054000	123	383028022	132	390308015	135
193088001	63	196001017	188	198200054G	80	351100000	123	383035000	131	391015012	136
193088002	62	196001018	186	198304015	41	351102000	123	383035001	131	391018012	136
193088003	64	196001019	186	198304022	41	351108000	123	383035002	132	391018015	136
193088004	64	196001020	187	198304022G	80	351114000	123	383035003	132	391022012	136
193088006	63	196001021	187	199015000	70,142	351150001	123	383035012	132	391022015	136
193108000	62	196002000	192	199015000HT	106	351212000	123	383042000	131	391022018	136
193108000G	88	196002001	193	199015001	71	351300000	123	383042001	131	391028015	136
193108001	63	19600200N	198	199015002	71	351304000	123	383042002	132	391028018	136
193108002	62	19600201N	198	199018000	70,142	351308000	123	383042003	132	391028022	136
193108003	64	19600202N	198	199018000HT	106	375100028	141	383042012	132	391035022	136
193108004	64	19600204N	198	199018001	71	375102018	141	383042022	132	391035028	136
193108006	63	19600205N	198	199018002	71	375112042	141	383054000	131	391042022	136
193139000	62	196003001	193	199022000	70,142	375114035	141	383054001	131	391042028	136
193139001	63	19600300N	198	199022000HT	106	375200054	141	383054002	132	391042035	136
193168000	62	196004000	192	199022001	71	375212076	141	383054003	132	391054022	136
193168001	63	196004001	193	199022002	71	375300088	141	383054012	132	391054028	136
194015900	60	196005000	192	199028000	70,142	375304022	141	383054022	132	391054035	136
194018150	61	196012000	190	199028000HT	106	375308012	141	383076000	131	391054042	136
194018300	61	196012001	189	199028001	71	375308015	141	383076001	131	391076042	136
194018900	60	196012002	189	199028002	71	375400108	141	383076003	132	391076054	136
194022300	61	19601200N	195	199035000	70,142	379012000	136	383088000	131	391088054	136
194022900	60	196015000	190	199035000HT	106	379015000	136	383088001	131	391088076	136
194028150	61	196015001	189	199035001	71	379018000	136	383088003	132	391108076	136
194028300	61	196015002	189	199035002	71	379022000	136	383108000	131	391108088	136
194028600	61	19601500N	195	199042000	70,142	379028000	136	383108001	131	392012015	128
194028900	60	196015035K	190	199042000HT	106	381012900	125	383108003	132	392015012	129
194035150	61	196015035KV	190	199042001	71	381012901	125	384015000	133	392015018	128
194035300	61	196015035N	195	199042002	71	381015450	124	384015001	133	392015022	128
194035600	61	196015035NV	195	199054000	70,142	381015451	124	384018000	133	392018012	129
194035900	60	196018000	190	199054000HT	106	381015900	125	384018001	133	392018015	129
194042150	61	196018001	189	199054001	71	381015901	125	384022000	133	392018022	128
194042300	61	196018002	189	199054002	71	381018450	124	384022001	133	392022012	129
194042600	61	19601800N	195	199076000	70,142	381018451	124	384028000	133	392022015	129
194042900	60	196022000	190	199088000	70,142	381018900	125	384028001	133	392022018	129
194054150	61	196022001	189	199108000	70,142	381018901	125	384035000	133	392022028	128
194054300	61	196022002	189	269100028	55	381022450	124	384035001	133	392028015	129
194054600	61	19602200N	195	269100128	55	381022451	124	384042000	133	392028018	129
194054900	60	196028000	190	269102015	55	381022900	125	384042001	133	392028022	129
194076150	61	196028002	189	269102018	55	381022901	125	384054000	133	392035015	129
194076300	61	19602800N	195	269102022	55	381028450	124	384054001	133	392035018	129
194088150	61	196035000	190	269102115	55	381028451	124	385102015	126	392035022	129
194088300	61	196035002	189	269102118	55	381028900	125	385102018	126	392035028	129
194108150	61	19603500N	195	269102122	55	381028901	125	385304022	126	392042022	129
194108300	61	196042004	190	269112042	55	381035450	124	385308015	126	392042028	129
195000015	72	19604200N	195	269112142	55	381035451	124	387100022	134	392042035	129
195000020	72	196042054	190	269114035	55	381035900	125	387100028	134	392054022	129
195000030	72	196042054K	191	269114135	55	381035901	125	387100035	134	392054028	129
195000040	72	196042054KF	191	269200054	55	381042450	124	387102015	134	392054035	129
195000050	72	196042054N	195	269200154	55	381042451	124	387102018	134	392054042	129
195015000	66	196042054V	196	269304018	55	381042900	125	387102022	134	392076022	129
195015003	68	196042054VN	196	269304022	55	381042901	125	387112035	134	392076028	129
195015004	69	196054004	190	269304028	55	381054450	124	387112042	134	392076035	129
195015005	68	19605400N	195	269304118	55	381054451	124	387114028	134	392076042	129
195015008	70	196076000	191	269304122	55	381054900	125	387114035	134	392076054	129
195015017	72	196076001	191	269304128	55	381054901	125	387200054	134	392088028	129
195015027	72	196076002	197	274000000	201	381076450	124	387212076	134	392088035	129
195018003	68	196076003	196	274000001	202	381076451	124	387300088	134	392088042	129
195018004	69	196076088V	198	274015001	202	381076900	125	387304015	134	392088054	129
195018005	68	196076108	191	274018001	202	381076901	125	387304018	134	392088076	129
195022003	68	196076108N	196	274022001	202	381088450	124	387304022	134	392108028	129
195022004	69	196088000	191	274028001	202	381088451	124	387304028	134	392108035	129
195022005	68	196088001	191	274035001	202	381088900	125	387308012	134	392108042	129
195022008	70	196088002	197	274042001	202	381088901	125	387308015	134	392108054	129
195028003	68	196088003	196	274054001	202	381108450	124	387400108	134	392108076	129
195028004	69	196108000	191	274076001	202	381108451	124	389100028	130	392108088	129
195028005	68	196108001	191	274088001	202	381108900	125	389100035	130	393015000	139
195035003	68	196108002	197	274108001	202	381108901	125	389100054	130	393015002	138
195035004	69	196108003	196	316012003	121	382012000	128	389102015	130	393018000	139
195035007	73	196139002	197	316012005	120	382015000	128	389102018	130	393018002	138
195042003	68	196168002	197	316015003	121	382018000	128	389102022	130	393022000	139
195042004	69	197100028	41	316015005	120	382022000	128	389102028	130	393022002	138
195042007	73	197100028G	80	316018003	121	382028000	128	389102035	130	393028000	139
195054003	68	197102015	41	316018005	120	382035000	128	389102042	130	393028002	138
195054004	69	197102015G	80	316022002	122	382042000	128	389102054	130	393035000	139
195054007	73	197102018	41	316022003	121	382054000	128	389102076	130	393035002	138
195076003	68	197102018G	80	316022005	120	382076000	128	389102088	130	393042000	139
195076004	69	197102022	41	316028002	122	382088000	128	389102108	130	393042002	138
195076007	73	197112042	41	316028003	121	382108000	128	389304022	130	393054000	139
195088003	68	197112042G	80	316028005	120	383012000	131	389304028	130	393054002	138
195088004	69	197114035	41	316035002	122	383012001	131	389304035	130	393076000	139
195088007	73	197114035G	80	316035003	121	383012003	132	389304042	130	393076002	138
195108003	68	197200054	41	316035005	120	383015000	131	389304054	130	393088000	139
195108004	69	197200054G	80	316042002	122	383015001	131	389304076	130	393088002	138
195108007	73	197304022	41	316042003	121						

393304118	137	616035000CN	168	681042300CN	170	683018000CN	176	685102015G	166	690100028CN	177
393304122	137	616042000CN	168	681042301CN	170	683018000G	163	685102018	154	690100028G	165
394015900	137	616054000CN	168	681042450	146	683018001	151	685102018G	166	690100035	153
394018900	137	616076000CN	168	681042450CN	171	683018001CN	176	685304022	154	690100035G	165
394022900	137	616088000CN	168	681042450G	158	683018001G	163	685304022G	166	690102012	153
394028150	138	616108000CN	168	681042451	146	683018003	150	687100022	152	690102015	153
394028300	138	679015001CN	183	681042451CN	171	683018003G	162	687100022G	164	690102015CN	177
394028900	137	679018001CN	183	681042451G	158	683022000	151	687100028	152	690102015G	165
394035150	138	679022001CN	183	681042600CN	172	683022000CN	176	687100028CN	177	690102018	153
394035300	138	679028001CN	183	681042601CN	172	683022000G	163	687100028G	164	690102018CN	177
394035900	137	679035001CN	183	681042900	147	683022001	151	687100035	152	690102018G	165
394042150	138	679042001CN	183	681042900CN	173	683022001CN	176	687100035G	164	690102022	153
394042300	138	679054001CN	183	681042900G	159	683022001G	163	687102012	152	690102022CN	177
394042900	137	679076001CN	183	681042901	147	683022003	150	687102015	152	690102022G	165
394054150	138	679088001CN	183	681042901CN	173	683022003G	162	687102015CN	177	690102028	153
394054300	138	679108001CN	183	681042901G	159	683028000	151	687102015G	164	690102028CN	177
394054900	137	681012450	146	681054150CN	169	683028000CN	176	687102018	152	690102028G	165
395012012	143	681012451	146	681054151CN	169	683028000G	163	687102018CN	177	690112042	153
395015012	143	681012900	147	681054300CN	170	683028001	151	687102018G	164	690112042CN	177
395015015	143	681012901	147	681054301CN	170	683028001CN	176	687102022	152	690112042G	165
395018012	143	681015150CN	169	681054450	146	683028001G	163	687102022CN	177	690114028	153
395018015	143	681015151CN	169	681054450CN	171	683028003	150	687102022G	164	690114028G	165
395022012	143	681015300CN	170	681054450G	158	683028003G	162	687112035	152	690114035	153
395022015	143	681015301CN	170	681054451	146	683035000	151	687112035G	164	690114035CN	177
395028012	143	681015450	146	681054451CN	171	683035000CN	176	687112042	152	690114035G	165
395028015	143	681015450CN	171	681054451G	158	683035000G	163	687112042CN	177	690114042	165
396012012	143	681015450G	158	681054600CN	172	683035001	151	687112042G	164	690114042G	163
396015012	143	681015451	146	681054601CN	172	683035001CN	176	687112054	152	690200054	153
396015015	143	681015451CN	171	681054900	147	683035001G	163	687112054G	164	690200054CN	177
396018012	143	681015451G	158	681054900CN	173	683035003	150	687114028	152	690200054G	165
396018015	143	681015900	147	681054900G	159	683035003G	162	687114028G	164	690304015	153
396022012	143	681015900CN	173	681054901	147	683042000	151	687114035	152	690304015G	165
396022015	143	681015900G	159	681054901CN	173	683042000CN	176	687114035CN	177	690304018	153
396028012	143	681015901	147	681054901G	159	683042000G	163	687114035G	164	690304018CN	177
396028015	143	681015901CN	173	681076150CNC	169	683042001	151	687114042	152	690304018G	165
396035015	143	681015901G	159	681076151CNC	169	683042001CN	176	687114042G	164	690304022	153
396102015V	141	681018450	146	681076300CN	170	683042001G	163	687200054	152	690304022CN	177
396102018V	141	681018450CN	171	681076301CN	170	683042003	150	687200054CN	177	690304022G	165
397100028	126	681018450G	158	681076450CN	171	683042003G	162	687200054G	164	690304028	153
397102015	126	681018451	146	681076451CN	171	683054000	151	687304015	152	690304028G	165
397102018	126	681018451CN	171	681076600CN	172	683054000CN	176	687304015G	164	690308012	153
397112042	126	681018451G	158	681076601CN	172	683054000G	163	687304018	152	690308015	153
397114035	126	681018900	147	681076900CN	173	683054001	151	687304018CN	177	690308015G	165
397200054	126	681018900CN	173	681076901CN	173	683054001CN	176	687304018G	164	690105012	154
397304022	126	681018900G	159	681088150CNC	169	683054001G	163	687304022	152	690108012	154
397308012	126	681018901	147	681088151CNC	169	683054003	150	687304022CN	177	690108015	154
397308015	126	681018901CN	173	681088300CN	170	683054003G	162	687304022G	164	690108015CN	179
398102028	126	681018901G	159	681088301CN	170	683076000CN	176	687304028	152	690108015G	166
398304022	126	681022150CN	169	681088450CN	171	683076001CN	176	687304028G	164	691022015	154
398304028	126	681022151CN	169	681088451CN	171	683088000CN	176	687308012	152	691022015CN	179
399015015	142	681022300CN	170	681088600CN	172	683088001CN	176	687308015	152	691022015G	166
399018015	142	681022301CN	170	681088601CN	172	683108000CN	176	687308015G	164	691022018	154
399022015	142	681022450	146	681088900CN	173	683108001CN	176	689100028	150	691022018CN	179
399022018	142	681022450CN	171	681088901CN	173	684012003	155	689100028G	161	691022018G	166
399028015	142	681022450G	158	68108150CNC	169	684012013	155	689100035	150	691028015	154
399028018	142	681022451	146	68108151CNC	169	684015001CN	178	689100035G	161	691028015CN	179
434015000	65, 140, 181	681022451CN	171	681108300CN	170	684015002	155	689102012	150	691028015G	166
434015000G	89	681022451G	158	681108301CN	170	684015002CN	178	689102015	150	691028018	154
434015006	65, 139, 181	681022900	147	681108450CN	171	684015003	155	689102015CN	174	691028018G	166
434020000	65, 140, 181	681022900CN	173	681108451CN	171	684015003CN	179	689102015G	161	691028022	154
434020000G	89	681022900G	159	681108600CN	172	684015012	155	689102018	150	691028022CN	179
434020006	65, 139, 181	681022901	147	681108601CN	172	684015013	155	689102018CN	174	691028022G	166
434025000	65, 140, 181	681022901CN	173	681108900CN	173	684018001CN	178	689102018G	161	691035022	154
434025000G	89	681022901G	159	681108901CN	173	684018002	155	689102022	150	691035022CN	179
434025006	65, 139, 181	681028150CN	169	682012000	149	684018002CN	178	689102022CN	174	691035022G	166
434032000	65, 140, 181	681028151CN	169	682015000	149	684018003	155	689102022G	161	691035028	154
434032000G	89	681028300CN	170	682015000CN	174	684018003CN	179	689102028	150	691035028CN	179
434032006	65, 139, 181	681028301CN	170	682015000G	161	684018012	155	689102028CN	174	691035028G	166
434040000	65, 140, 181, 234	681028450	146	682018000	149	684018013	155	689102028G	161	691042022	154
434040000G	89	681028450CN	171	682018000CN	174	684022001CN	178	689102035	150	691042022CN	179
434040006	65, 139, 181, 234	681028450G	158	682018000G	161	684022002	155	689102035CN	174	691042022G	166
434050000	65, 140, 181, 234	681028451	146	682022000	149	684022002CN	178	689102035G	161	691042028	154
434050000G	89	681028451CN	171	682022000CN	174	684022003	155	689102042	150	691042028CN	179
434050006	65, 139, 181, 234	681028451G	158	682022000G	161	684022003CN	179	689102042CN	174	691042028G	166
434065000	65, 140, 181, 234	681028600CN	172	682028000	149	684022012	155	689102042G	161	691042035	154
434065000G	89	681028900	147	682028000CN	174	684022013	155	689102054	150	691042035CN	179
434065006	65, 139, 181, 234	681028900CN	173	682028000G	161	684022023	155	689102054CN	174	691042035G	166
434080000	65, 140, 181, 234	681028900G	159	682035000	149	684028001CN	178	689102054G	161	691054022	154
434080000G	89	681028901	147	682035000CN	174	684028002	155	689304022	150	691054022G	166
434080006	65, 139, 181, 234	681028901CN	173	682035000G	161	684028002CN	178	689304022CN	174	691054028	154
434100000	65, 140, 181, 234	681028901G	159	682042000	149	684028003	155	689304022G	161	691054028CN	179
434100000G	89	681035150CN	169	682042000CN	174	684028003CN	179	689304028	150	691054028G	166
434100006	65, 139, 181, 234	681035151CN	169	682042000G	161	684035001CN	178	689304028CN	174	691054035	154
434125000	234	681035300CN	170	682054000	149	684035002	155	689304028G	161	691054035CN	179
434125006	234	681035301CN	170	682054000CN	174	684035002CN	178	689304035	150	691054035G	166
434150000	234	681035450	146	682054000G	161	684035003	155	689304035CN	174	691054042	154
434150006	234										

692022015	149	693108002CN	180	802080050	213	805065000	217	813125100	223	820100006	230
692022015CN	175	693108003CN	182	802080075	213	805065045	218	813150100	223	820100010	230
692022015G	162	693108004CN	182	802080100	213	805065087	217	813150125	223	820125006	230
692022018	149	695015003CN	183	802080150	213	805080045	218	814050045	224	820125010	230
692022018G	162	695015004CN	184	802080200	213	805080087	217	814050087	224	820150006	230
692028015	149	695018003CN	183	802080250	213	805100015	218	814065045	224	820150010	230
692028015CN	175	695018004CN	184	802080300	213	805100030	218	814065087	224	820205000	230
692028015G	162	695022003CN	183	802100025	213	805100045	218	814080045	224	820260000	230
692028018	149	695022004CN	184	802100050	213	805100087	217	814080087	224	821040006	232
692028018CN	175	695022008CN	185	802100075	213	805125015	218	814100045	224	821040010	232
692028018G	162	695028003CN	183	802100100	213	805125030	218	814100087	224	821050006	232
692028022	149	695028004CN	184	802100150	213	805125045	218	814125045	224	821050010	232
692028022CN	175	695035003CN	183	802100200	213	805125087	217	814125087	224	821065006	232
692028022G	162	695035004CN	184	802100250	213	805150015	218	814150045	224	821065010	232
692035015	149	695042003CN	183	802100300	213	805150030	218	814150087	224	821080006	232
692035015CN	175	695042004CN	184	802125025	213	805150045	218	815050040	225	821080010	232
692035015G	162	695054003CN	183	802125050	213	805150087	217	815065050	225	821100006	232
692035018	149	695054004CN	184	802125075	214	806065075	219	815080050	225	821100010	232
692035018G	162	695076003CN	183	802125100	214	806065130	219	815100065	225	821125006	232
692035022	149	695076004CN	184	802125150	214	806065200	219	815100080	225	821125010	232
692035022CN	175	695088003CN	183	802125200	214	806080075	219	815125100	225	821150006	232
692035022G	162	695088004CN	184	802125250	214	806080130	219	815150100	225	821150010	232
692035028	149	695108003CN	183	802125300	214	806080200	219	815150125	225	822040006	233
692035028CN	175	695108004CN	184	802150025	214	806100075	219	816050040	225	822040010	233
692035028G	162	697100028	148	802150050	214	806100130	219	816065050	225	822050006	233
692042015	149	697100028G	160	802150075	214	806100200	219	816100065	225	822050010	233
692042015G	162	697102012	148	802150100	214	806125075	219	816125100	225	822065006	233
692042018	149	697102015	148	802150150	214	806125130	219	816150100	225	822065010	233
692042018G	162	697102015G	160	802150200	214	806125200	219	816150125	225	822080006	233
692042022	149	697102018	148	802150250	214	807050040	219	817050040	226	822080010	233
692042022CN	175	697102018G	160	802150300	214	807065050	219	817065040	226	822100006	233
692042022G	162	697102022	148	8030400250	214	807080000	219	817065050	226	822100010	233
692042028	149	697102022G	160	8030400500	214	807100000	219	817080065	226	822125006	233
692042028CN	175	697102028	148	8030400750	214	807125000	219	817100050	226	822125010	233
692042028G	162	697102028G	160	8030401000	214	808040045	220	817100065	226	822150006	233
692042035	149	697112042	148	8030401500	214	808040087	220	817100080	226	822150010	233
692042035CN	175	697112042G	160	8030402000	214	808050045	220	817125065	226	823040000	235
692042035G	162	697114035	148	8030402500	214	808050087	220	817125100	226	823040001	235
692054022	149	697114035G	160	8030403000	214	808065045	220	817150100	226	823040002	236
692054022CN	175	697200054	148	8030500250	214	808065087	220	817150125	226	823040003	236
692054022G	162	697200054G	160	8030500500	214	808080045	220	818050040	226	823040004	237
692054028	149	697304018	148	8030500750	214	808080087	220	818065050	226	823050000	235
692054028CN	175	697304018G	160	8030501000	214	808100045	220	818080065	226	823050001	235
692054028G	162	697304022	148	8030501500	214	808100087	220	818100050	226	823050002	236
692054035	149	697304022G	160	8030502000	214	808125045	220	818100065	226	823050003	236
692054035CN	175	697308012	148	8030502500	214	808125087	220	818100080	226	823050004	237
692054035G	162	697308015	148	8030503000	214	808150045	220	818125100	226	823065000	235
692054042	149	697308015G	160	8030650250	215	808150087	220	818150125	226	823065001	235
692054042CN	175	698100022	148	8030650500	215	809050040	221	819040000	227	823065002	236
692054042G	162	698100022G	160	8030650750	215	809065040	221	819040001	227	823065003	236
692076022CN	175	698100028	148	8030651000	215	809065050	221	819040002	228	823065004	237
692076028CN	175	698100028G	160	8030651500	215	809080050	221	819040003	228	823080000	235
692076035CN	175	698102012	148	8030652000	215	809100040	221	819040004	229	823080001	235
692076042CN	175	698102015	148	8030652500	215	809100050	221	819050000	227	823080002	236
692076054CN	175	698102015G	160	8030653000	215	809100065	221	819050001	227	823080003	236
692088022CN	175	698102018	148	8030800750	215	809100080	221	819050002	228	823080004	237
692088028CN	175	698102018G	160	8030801000	215	809125050	221	819050003	228	823100000	235
692088035CN	175	698102022	148	8030801500	215	809125065	221	819050004	229	823100001	235
692088042CN	175	698102022G	160	8030802000	215	809125100	221	819065000	227	823100002	236
692088054CN	175	698102028	148	8030802500	215	809150065	221	819065001	227	823100003	236
692088076CN	175	698102028G	160	8030803000	215	809150100	221	819065002	228	823100004	237
692108022CN	175	698112042	148	8031000750	215	809150125	221	819065003	228	823125000	235
692108028CN	175	698112042G	160	8031001000	215	810050040	221	819065004	229	823125001	235
692108035CN	175	698114035	148	8031001500	215	810065040	221	819080000	227	823125002	236
692108042CN	175	698114035G	160	8031002000	215	810065050	221	819080001	227	823125004	237
692108054CN	175	698200054	148	8031002500	215	810080050	221	819080002	228	823150000	235
692108076CN	175	698200054G	160	8031003000	215	810080065	221	819080003	228	823150001	236
692108088CN	175	698304015	148	8031250750	215	810100040	221	819080004	229	823150002	236
693015000CN	180	698304015G	160	8031251000	215	810100050	221	819100000	227	823150004	237
693015002CN	180	698304018	148	8031251500	215	810100065	221	819100001	227	824050060	237
693018000CN	180	698304018G	160	8031252000	215	810100080	221	819100002	228	8240500750	237
693018002CN	180	698304022	148	8031252500	215	810125050	221	819100003	228	8240501000	237
693022000CN	180	698304022G	160	8031253000	215	810125065	221	819100004	229	8240501100	237
693022002CN	180	698308012	148	8031500750	215	810125100	221	819125000	227	8240501250	237
693022003CN	182	698308015	148	8031501000	215	810150065	221	819125001	227	8240501500	237
693022004CN	182	698308015G	160	8031501500	215	810150100	221	819125002	228	8240501600	237
693028000CN	180	802040025	213	8031502000	215	810150125	221	819125003	228	8240502000	237
693028002CN	180	802040050	213	8031502500	215	811050045	222	819125004	229	825040011	238
693028003CN	182	802040075	213	8031503000	215	811050087	222	819150000	227	825040022	238
693028004CN	182	802040100	213	804040015	217	811065045	222	819150001	227	825040033	238
693035000CN	180	802040150	213	804040030	216	811065087	222	819150002	228	825040044	239
693035002CN	180	802040200	213	804040045	216	811100045	222	819150003	228	825040055	239
693035003CN	182	802040250	213	804040087	216	811100087	222	819150004	229	825040066C	240
693035004CN	182	802040300	213	804050015	217	811125045	222	820000000	241	825040066Q	239
693042000CN	180	802050025	213	804050030	216	811125087	222	820040000	231	825040077C	240
693042002CN	180	802050050	213	804050045	216	811150045	222	820040006	230	825040077Q	240
693042003CN	182	802050075	213	804050087	216	811150087	222	820040010	230	825050011	238
693042004CN	182	802050100	213	804065015	217	812050040	223	820040100	231	825050022	238
693054000CN	180	802050150	213	804065030	216	81206					

825065066Q	239
825065077C	240
825065077Q	240
825100022	238
825100044	239
825100055	239
826000002	242
826040000	242
826040001	242
826050000	242
826050001	242
826065000	242
826065001	242
826080001	242
826100001	242
826125001	242
826150001	242
827040000	229
827050000	229
827065000	229
827080000	229
827100000	229
827125000	229
827150000	229
850NS000000	206



RACORDERIE METALLICHE

RACORDERIE METALLICHE S.P.A.

Head Office and Manufacturing Plant:

Strada Sabbionetana, 59

46010 Campitello di Marcaria (MN) ITALY

Tel. +39 0376 96001

Fax +39 0376 96422

info@racmet.com

racorderiemetalliche.com

follow us on   

CODE 009 R17 0621 PLU